

Ground Points in Engine Compartment <LHD 1GR-FE>

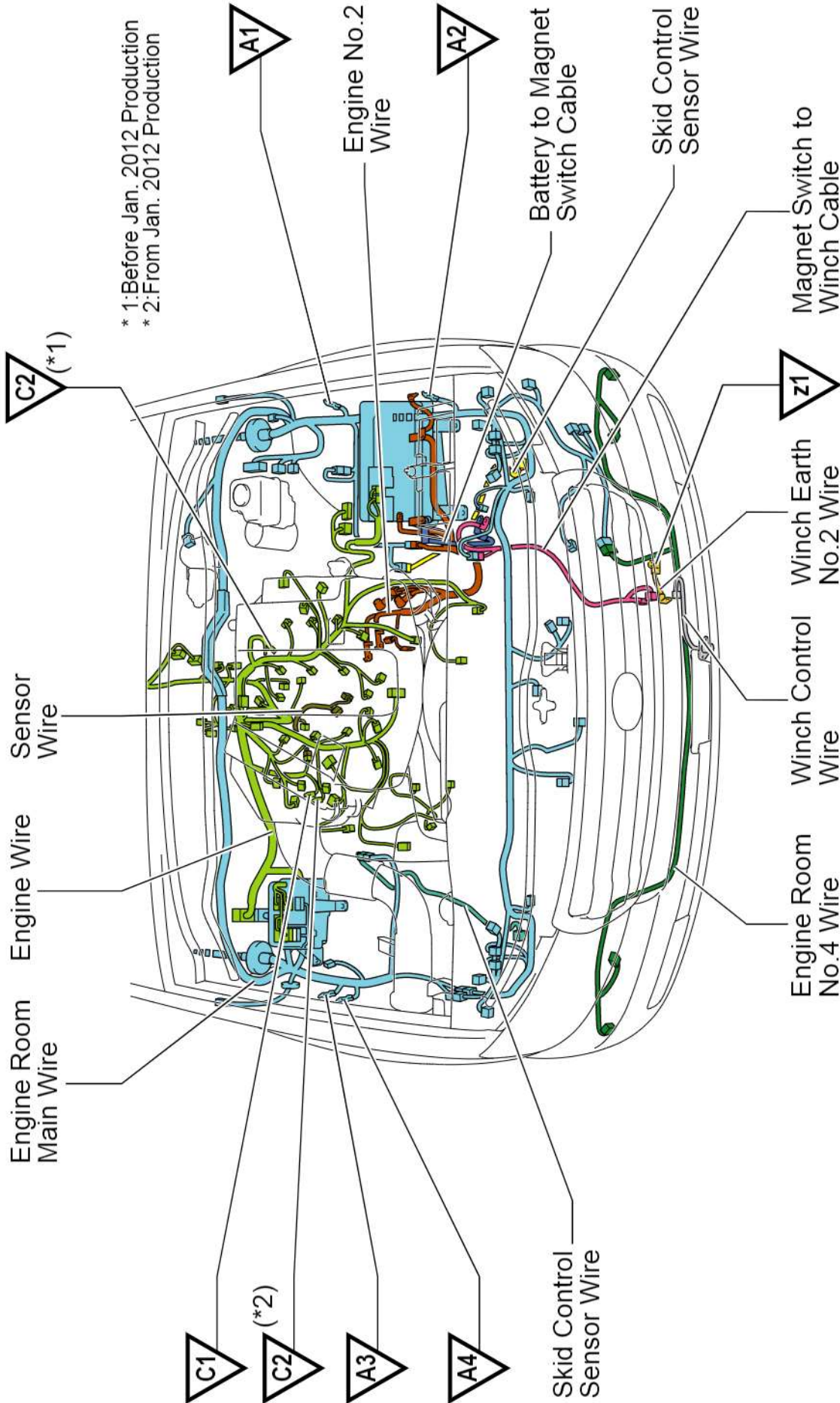

Position of Parts in Engine Compartment <LHD 1GR-FE>

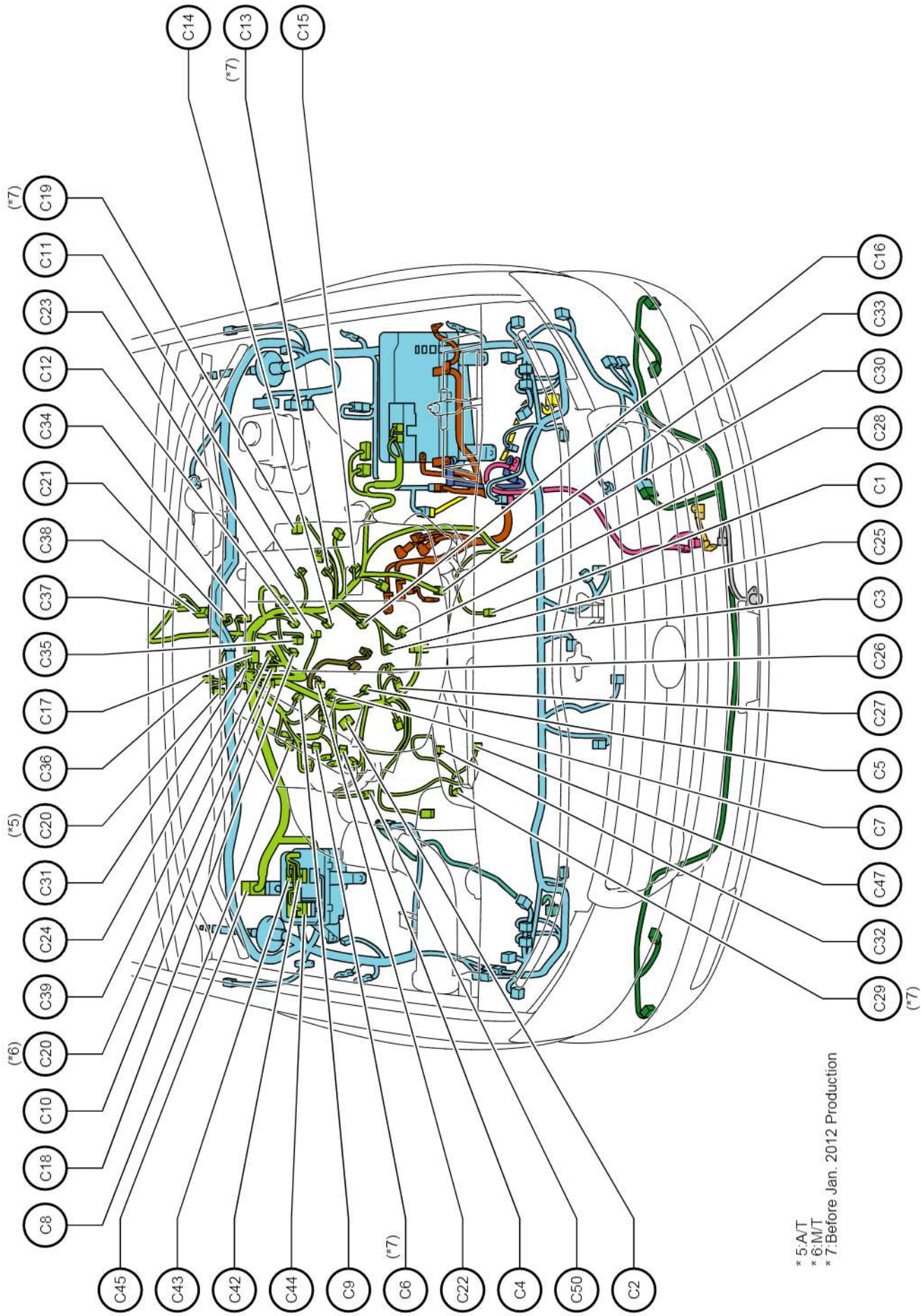

C 1	Crankshaft Position Sensor
C 2	Mass Air Flow Meter
C 3	Throttle Body Assembly
C 4	Ignition Coil Assembly No.1
C 5	Fuel Injector Assembly No.1
C 6	Ignition Coil Assembly No.3
C 7	Fuel Injector Assembly No.3
C 8	Ignition Coil Assembly No.5
C 9	Fuel Injector Assembly No.5
C 10	Noise Filter (Ignition Bank 1)
C 11	Ignition Coil Assembly No.6
C 12	Fuel Injector Assembly No.6
C 13	Ignition Coil Assembly No.4
C 14	Fuel Injector Assembly No.4
C 15	Ignition Coil Assembly No.2
C 16	Fuel Injector Assembly No.2
C 17	Noise Filter (Ignition Bank 2)
C 18	E.F.I. Engine Coolant Temperature Sensor
C 19	Purge VSV
C 20	Oxygen Sensor (Bank 1 Sensor 2)
C 21	Oxygen Sensor (Bank 2 Sensor 2)
C 22	Air Fuel Ratio Sensor (Bank 1 Sensor 1)
C 23	Air Fuel Ratio Sensor (Bank 2 Sensor 1)
C 24	Park/Neutral Position Switch
C 25	WT Sensor (Bank 2 Intake Side)
C 26	WT Sensor (Bank 1 Intake Side)
C 27	Camshaft Timing Oil Control Valve (Bank 1 Intake Side)
C 28	Camshaft Timing Oil Control Valve (Bank 2 Intake Side)
C 29	Power Steering Oil Pressure Switch
C 30	Cooler Compressor Assembly
C 31	VSV (ACIS)
C 32	Engine Oil Level Sensor
C 33	Oil Pressure Sender Gage Assembly
C 34	Electronically Controlled Transmission Solenoid
C 35	Transmission Revolution Sensor (Turbine)
C 36	Transmission Revolution Sensor (Counter Gear)
C 37	Transfer Shift Actuator Assembly
C 38	Transfer Shift Actuator Assembly
C 39	Back-Up Light Switch Assembly
C 42	Junction Connector
C 43	Junction Connector
C 44	Junction Connector
C 45	ECM
C 47	Oil Pressure Sender Gage Assembly

Position of Parts in Engine Compartment <LHD 1GR-FE>

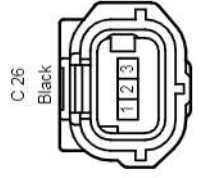
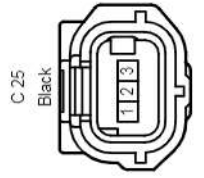
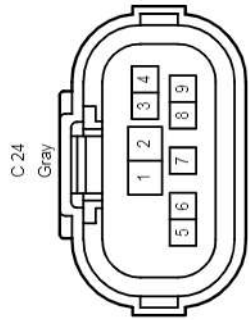
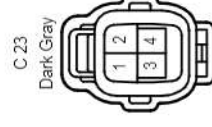
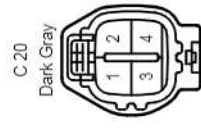
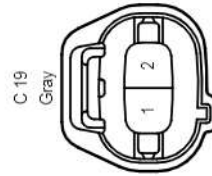
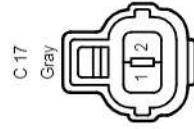
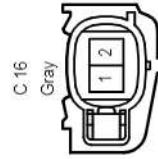
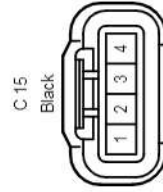
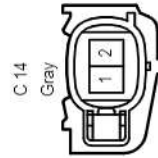
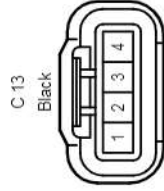
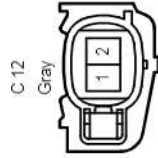
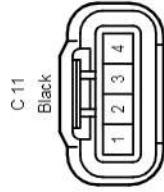
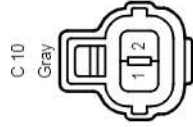
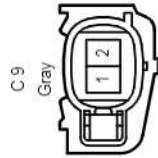
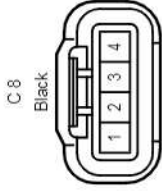
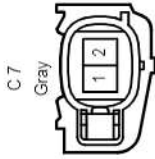
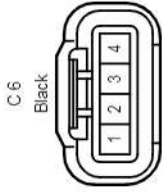
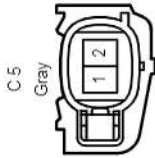
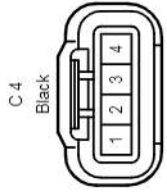
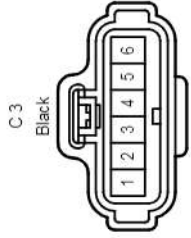
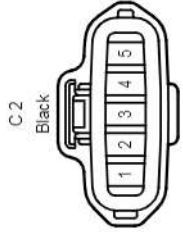
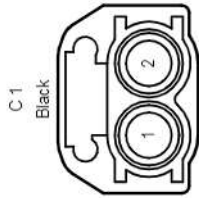

Position of Parts in Engine Compartment <LHD 1GR-FE>

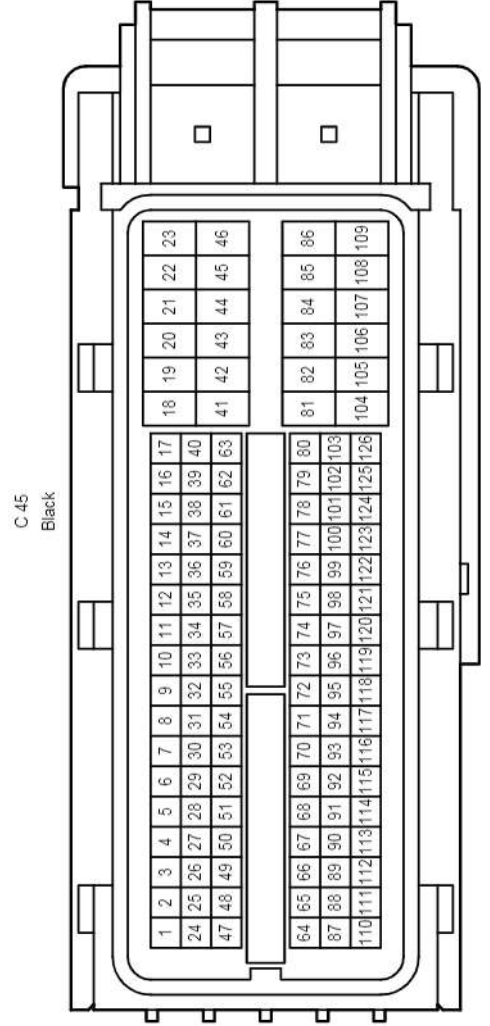
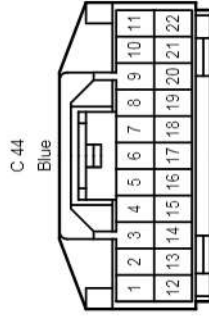
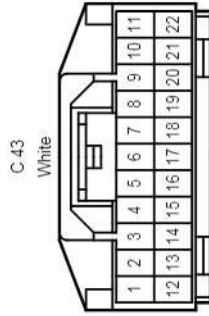
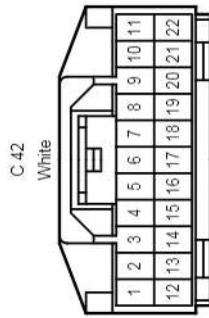
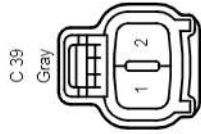
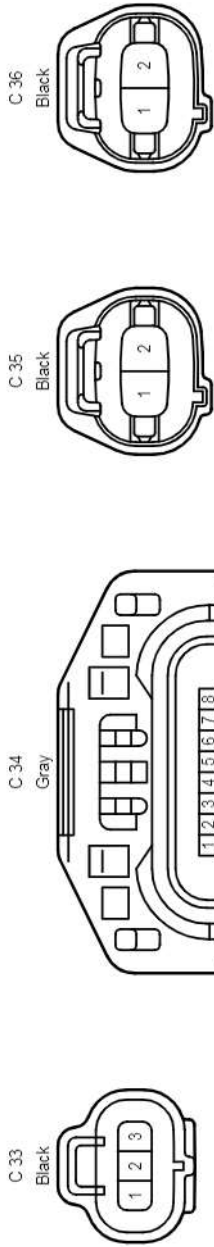

cardiagn.com

Position of Parts in Engine Compartment <LHD 1GR-FE>

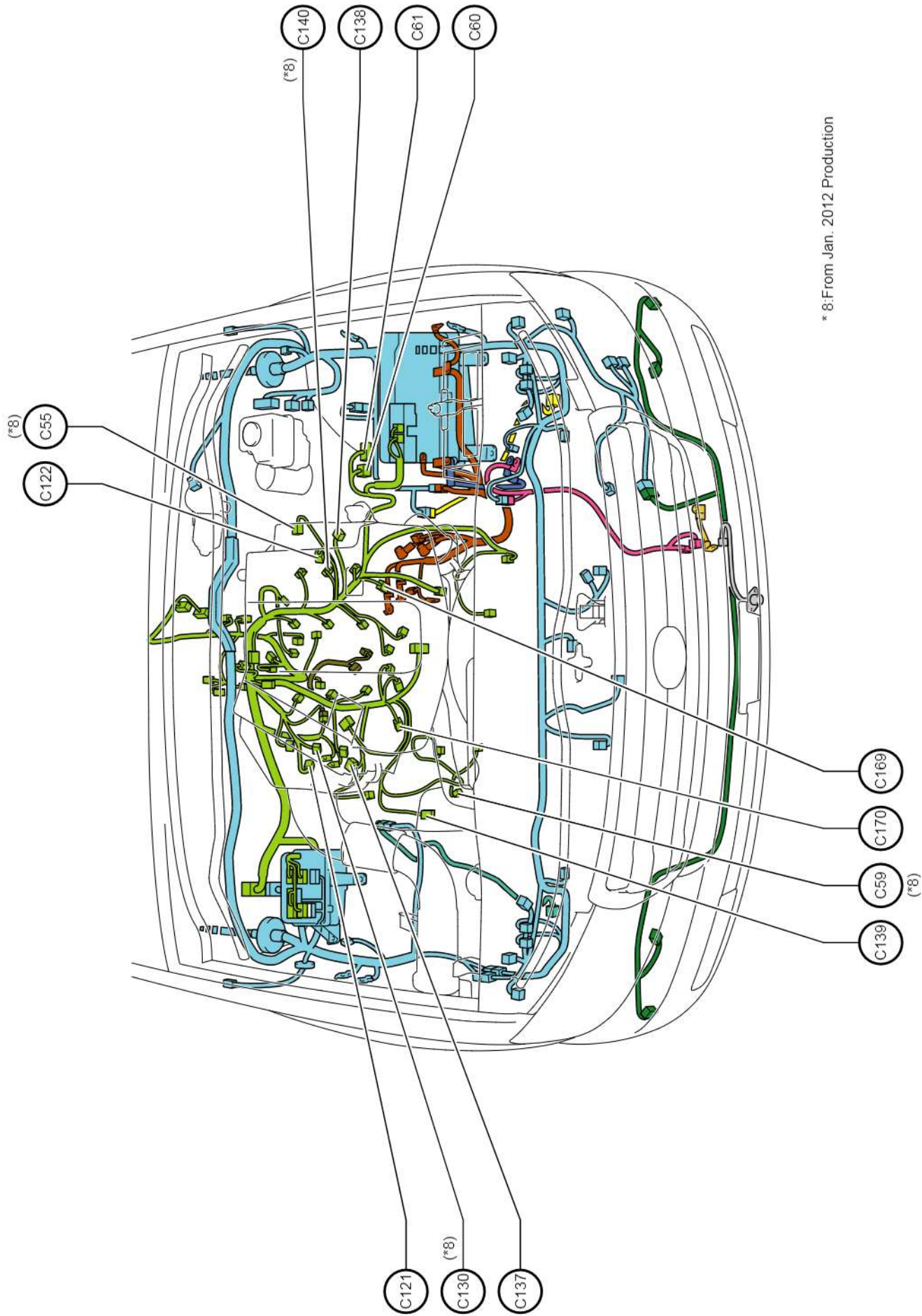

* 8: From Jan. 2012 Production

- C 55 Purge VSV
- C 59 Power Steering Oil Pressure Sensor
- C 60 Air Injection Control Driver
- C 61 Air Injection Control Driver
- C 121 VVT Sensor (Bank 1 Exhaust Side)
- C 122 VVT Sensor (Bank 2 Exhaust Side)
- C 130 Ignition Coil Assembly No.3
- C 137 Air Switching Valve (Bank 1)
- C 138 Air Switching Valve (Bank 2)
- C 139 Air Pump Assembly
- C 140 Ignition Coil Assembly No.4
- C 169 Camshaft Timing Oil Control Valve (Bank 1 Exhaust Side)
- C 170 Camshaft Timing Oil Control Valve (Bank 2 Exhaust Side)

Position of Parts in Engine Compartment <LHD 1GR-FE>

C-55
Black

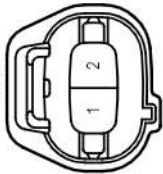

C-59
Gray

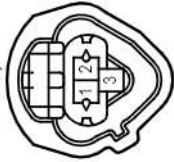

C-60
Black

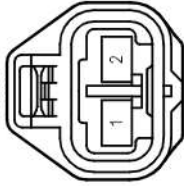

C-61
Black

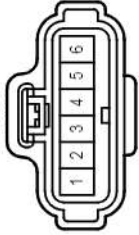

C-121
Black

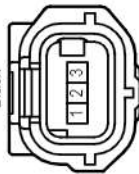

C-122
Black



C-130
Gray

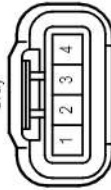

C-137
Black

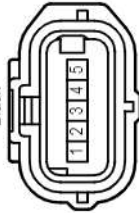

C-138
Black

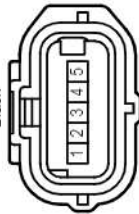

C-139
Black

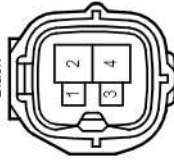

C-140
Gray

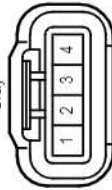

C-169
Gray



C-170
Gray



Position of Parts in Engine Compartment <LHD 1GR-FE>

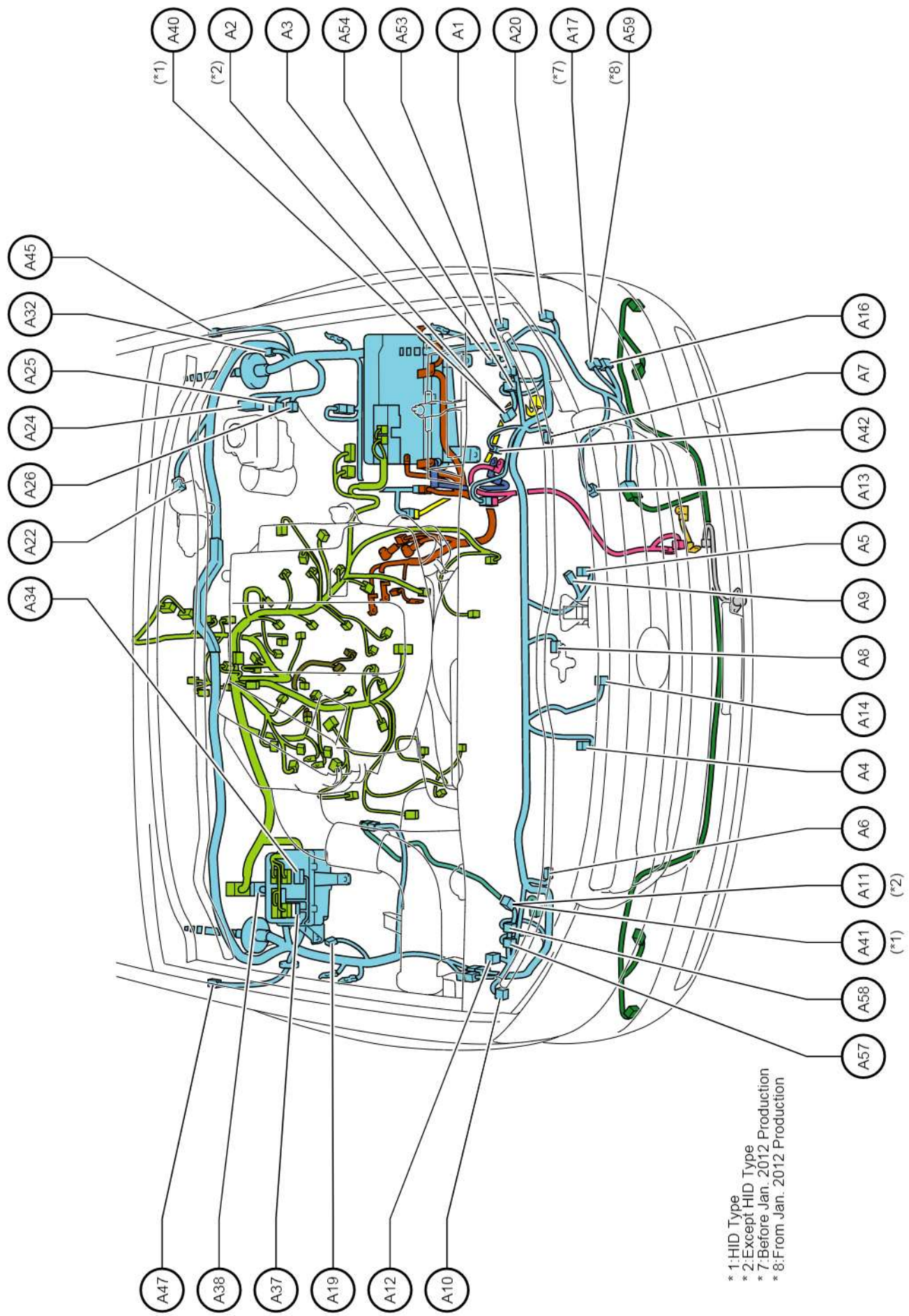

* 1: HID Type
 * 2: Except HID Type
 * 7: Before Jan. 2012 Production
 * 8: From Jan. 2012 Production

A 1	Headlight Assembly LH
A 2	Headlight Assembly LH
A 3	Headlight Assembly LH
A 4	High Pitched Horn Assembly
A 5	Low Pitched Horn Assembly
A 6	Front Airbag Sensor RH
A 7	Front Airbag Sensor LH
A 8	Engine Hood Courtesy Switch
A 8	Engine Hood Courtesy Switch
A 9	Condenser Blower Motor Assembly
A 10	Headlight Assembly RH
A 11	Headlight Assembly RH
A 12	Headlight Assembly RH
A 13	A/C Pressure Sensor
A 14	Ambient Temperature Sensor
A 16	Windshield Washer Motor and Pump Assembly
A 17	Headlight Cleaner Control Relay and Motor
A 19	Security Horn Assembly
A 20	Wireless Door Lock Buzzer
A 22	Windshield Wiper Motor Assembly
A 24	Skid Control ECU with Actuator Assembly
A 25	Skid Control ECU with Actuator Assembly
A 26	Brake Fluid Level Warning Switch (Brake Master Cylinder Reservoir Assembly)
A 32	Noise Filter
A 34	Junction Connector
A 37	Junction Connector
A 38	ECM
A 40	Headlight Assembly LH
A 41	Headlight Assembly RH
A 42	Winch Main Relay (No.1 Magnet Switch Assembly)
A 45	Side Turn Signal Light Assembly LH
A 47	Side Turn Signal Light Assembly RH
A 53	Headlight Assembly LH
A 54	Headlight Assembly LH
A 57	Headlight Assembly RH
A 58	Headlight Assembly RH
A 59	Headlight Cleaner Control Relay and Motor

Position of Parts in Engine Compartment <LHD 1GR-FE>

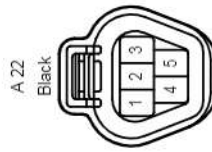
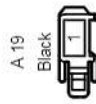
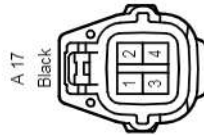
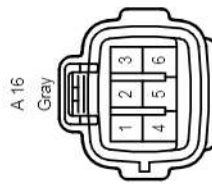
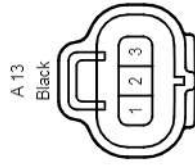
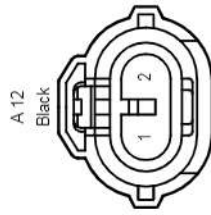
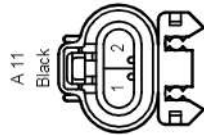
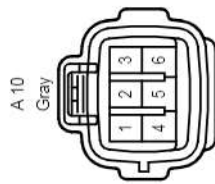
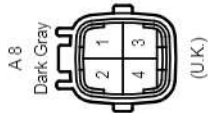
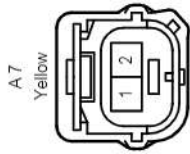
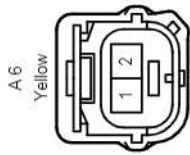
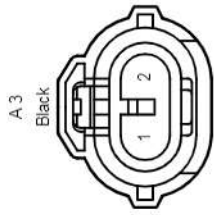
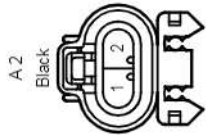
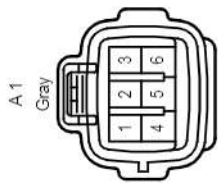

A 24
Black

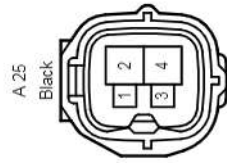
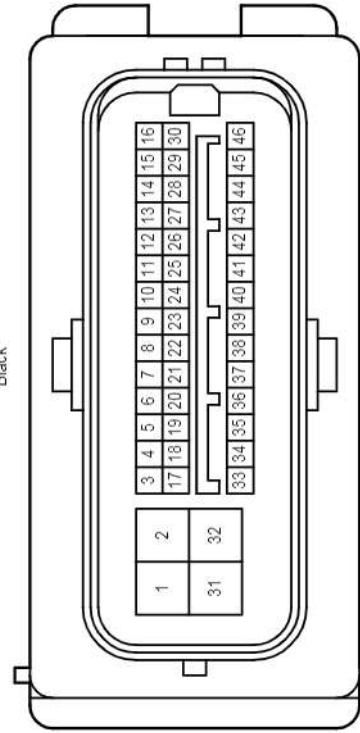

Position of Parts in Engine Compartment <LHD 1GR-FE>

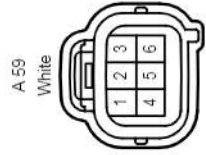
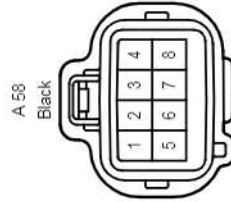
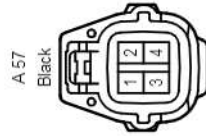
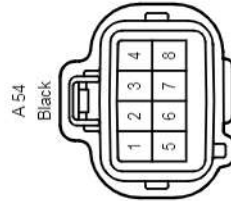
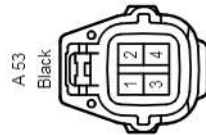
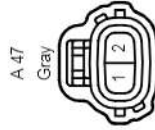
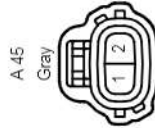
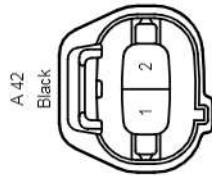
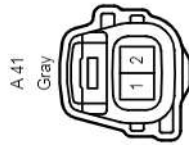
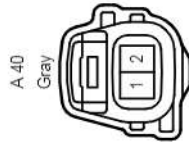
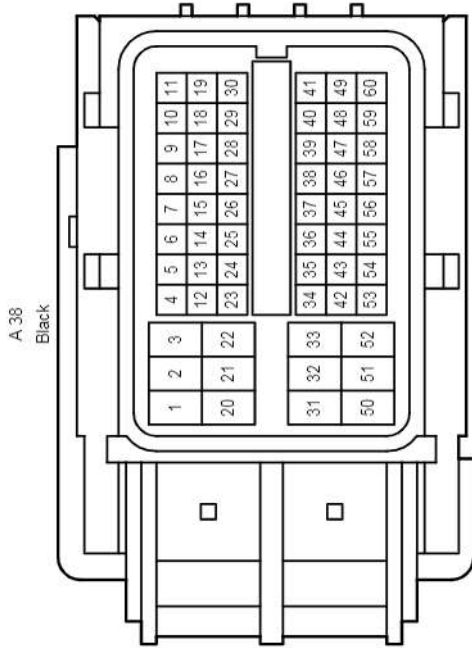
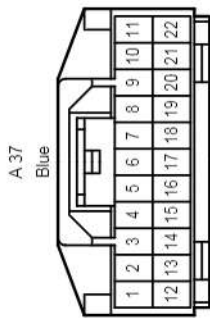

Position of Parts in Engine Compartment <LHD 1GR-FE>

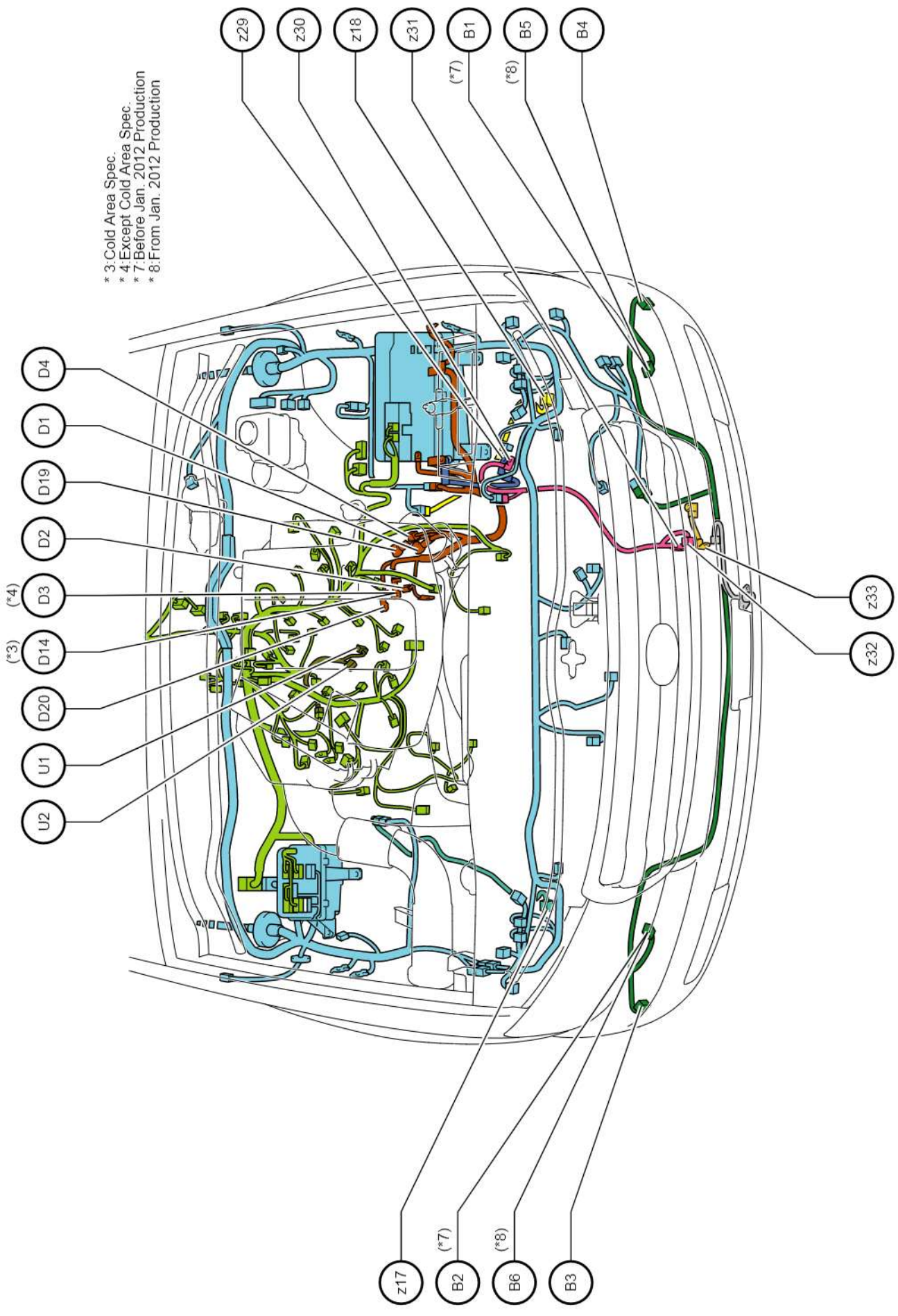

- * 3: Cold Area Spec.
- * 4: Except Cold Area Spec.
- * 7: Before Jan. 2012 Production
- * 8: From Jan. 2012 Production

B	1	Fog Light Assembly LH
B	2	Fog Light Assembly RH
B	3	No.1 Ultrasonic Sensor RH
B	4	No.1 Ultrasonic Sensor LH
B	5	Fog Light Assembly LH
B	6	Fog Light Assembly RH
D	1	Generator Assembly
D	2	Starter Assembly
D	3	Starter Assembly
D	4	Generator Assembly
D	14	Starter Assembly
D	19	Generator Assembly
D	20	Starter Assembly
U	1	Knock Control Sensor (Bank 2)
U	2	Knock Control Sensor (Bank 1)
Z	17	Front Speed Sensor RH
Z	18	Front Speed Sensor LH
Z	29	Winch Main Relay (No.1 Magnet Switch Assembly)
Z	30	Winch Main Relay (No.1 Magnet Switch Assembly)
Z	31	With Magnet Switch Winch Motor Assembly
Z	32	With Magnet Switch Winch Motor Assembly
Z	33	With Magnet Switch Winch Motor Assembly

Position of Parts in Engine Compartment <LHD 1GR-FE>

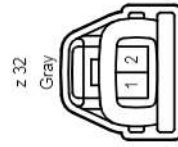
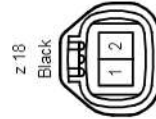
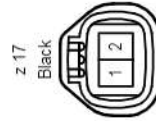
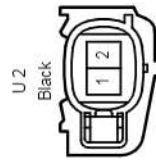
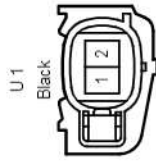
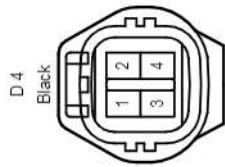
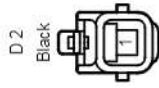
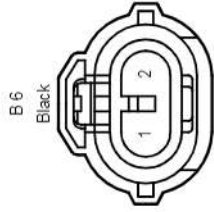
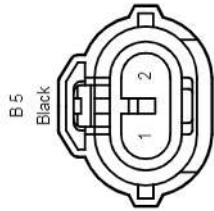
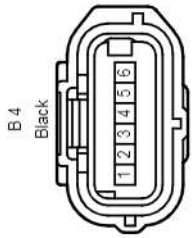
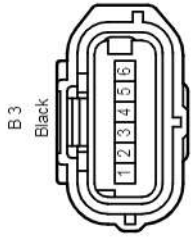
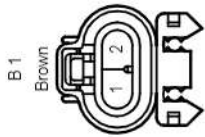

Wire and Wire in Engine Compartment <LHD 1GR-FE>

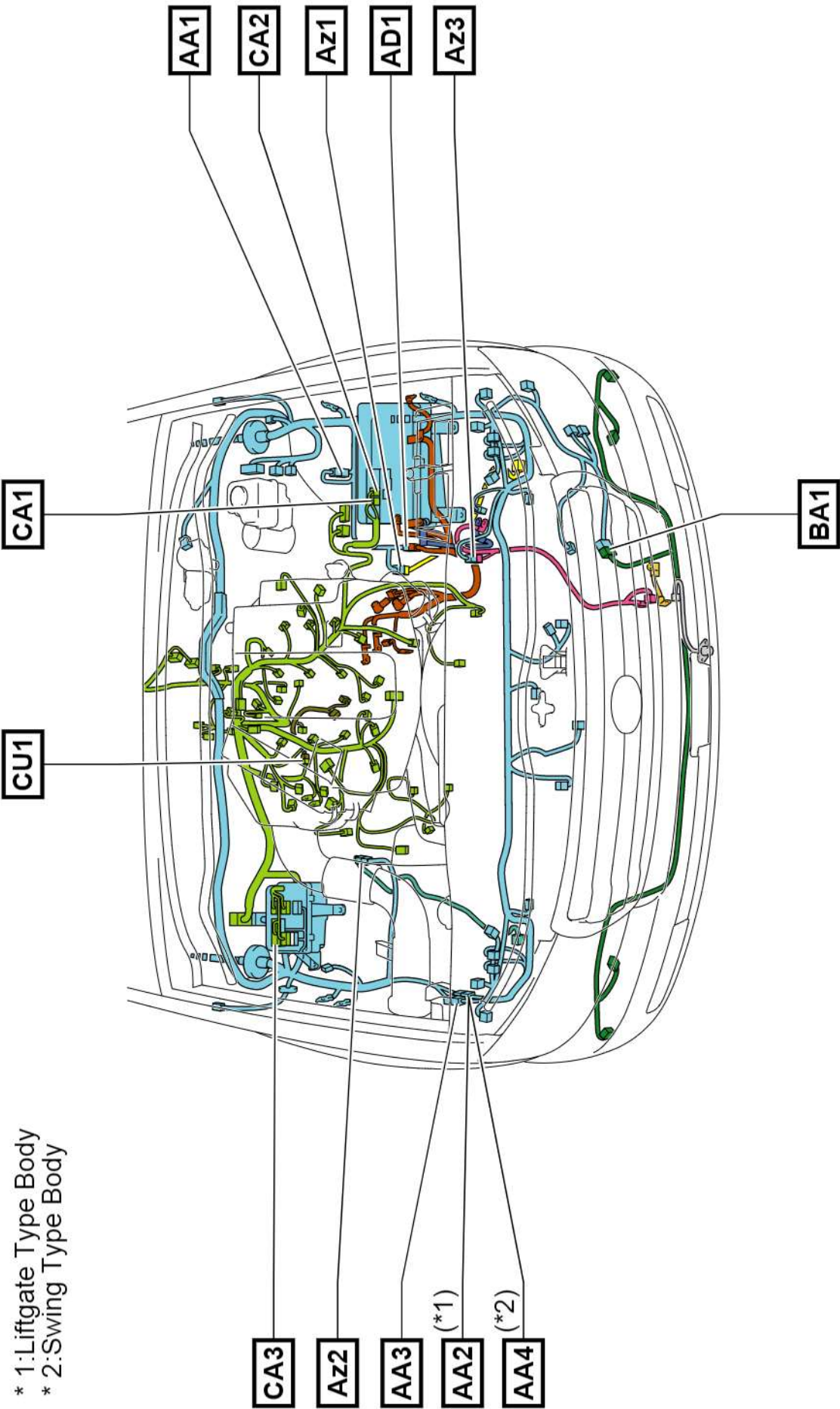

- * 1:Liftgate Type Body
- * 2:Swing Type Body

Wire and Wire in Engine Compartment <LHD 1GR-FE>

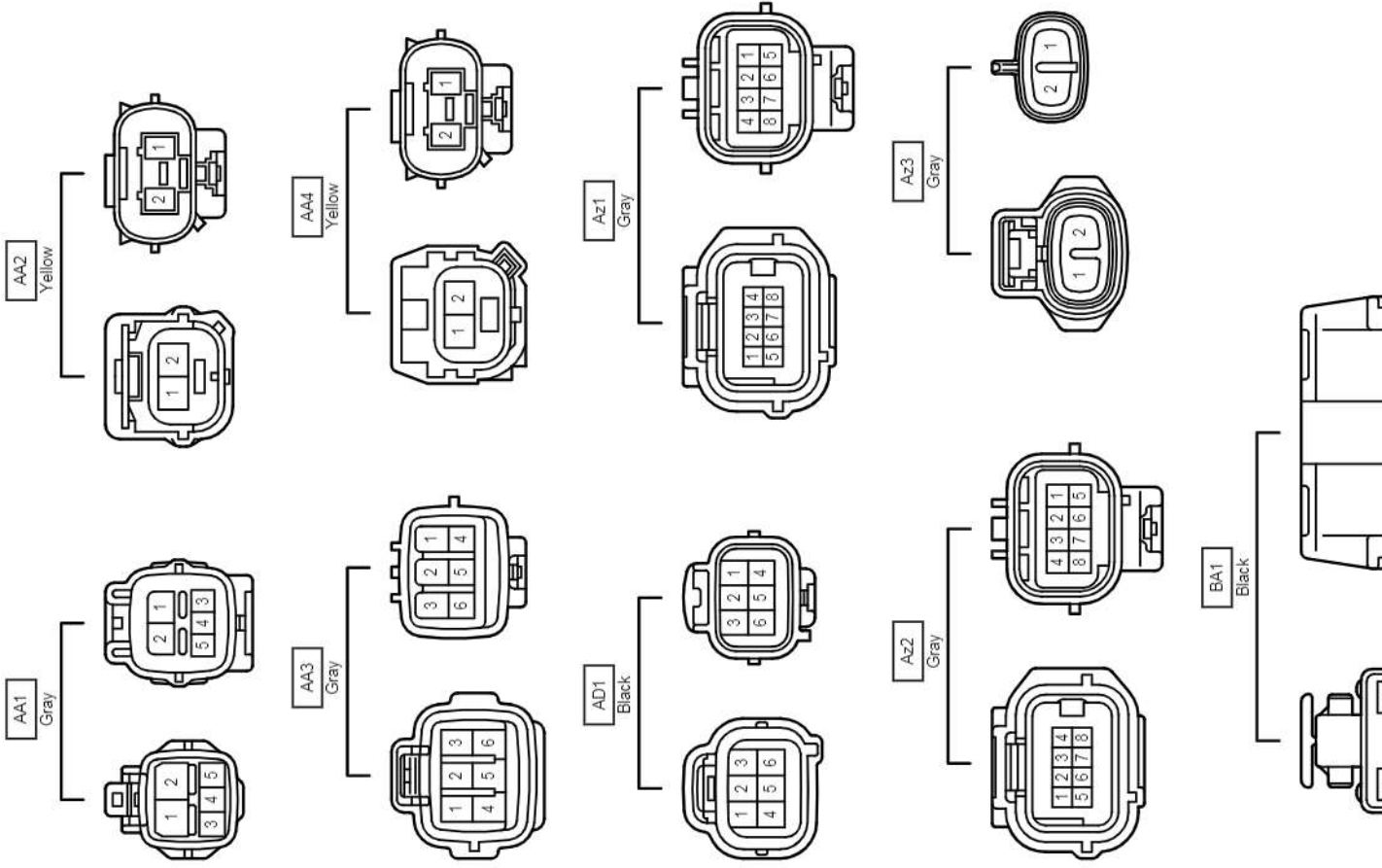

Wire and Wire in Engine Compartment <LHD 1GR-FE>

CA1
White

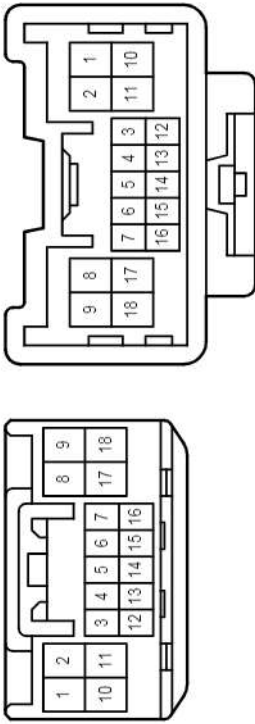

CA2
White

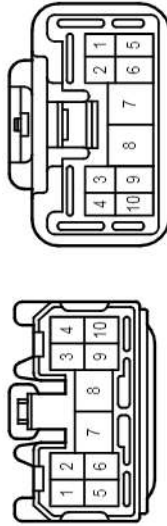

CA3
White

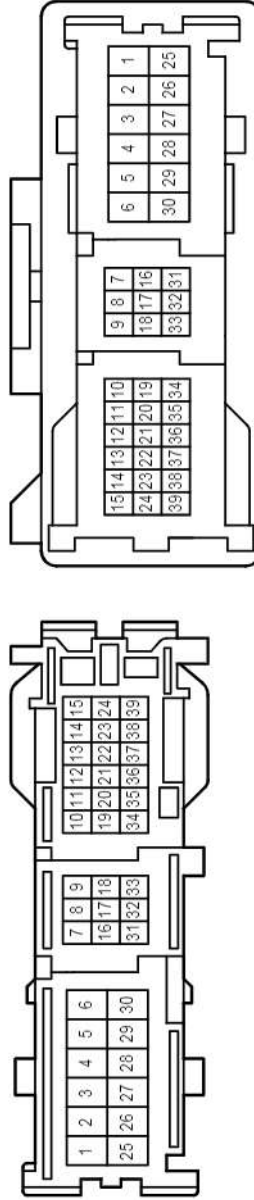

CU1
Black

Dark Gray

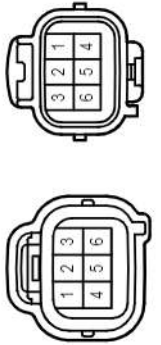

Position of Parts in Engine Compartment <RHD 1GR-FE>

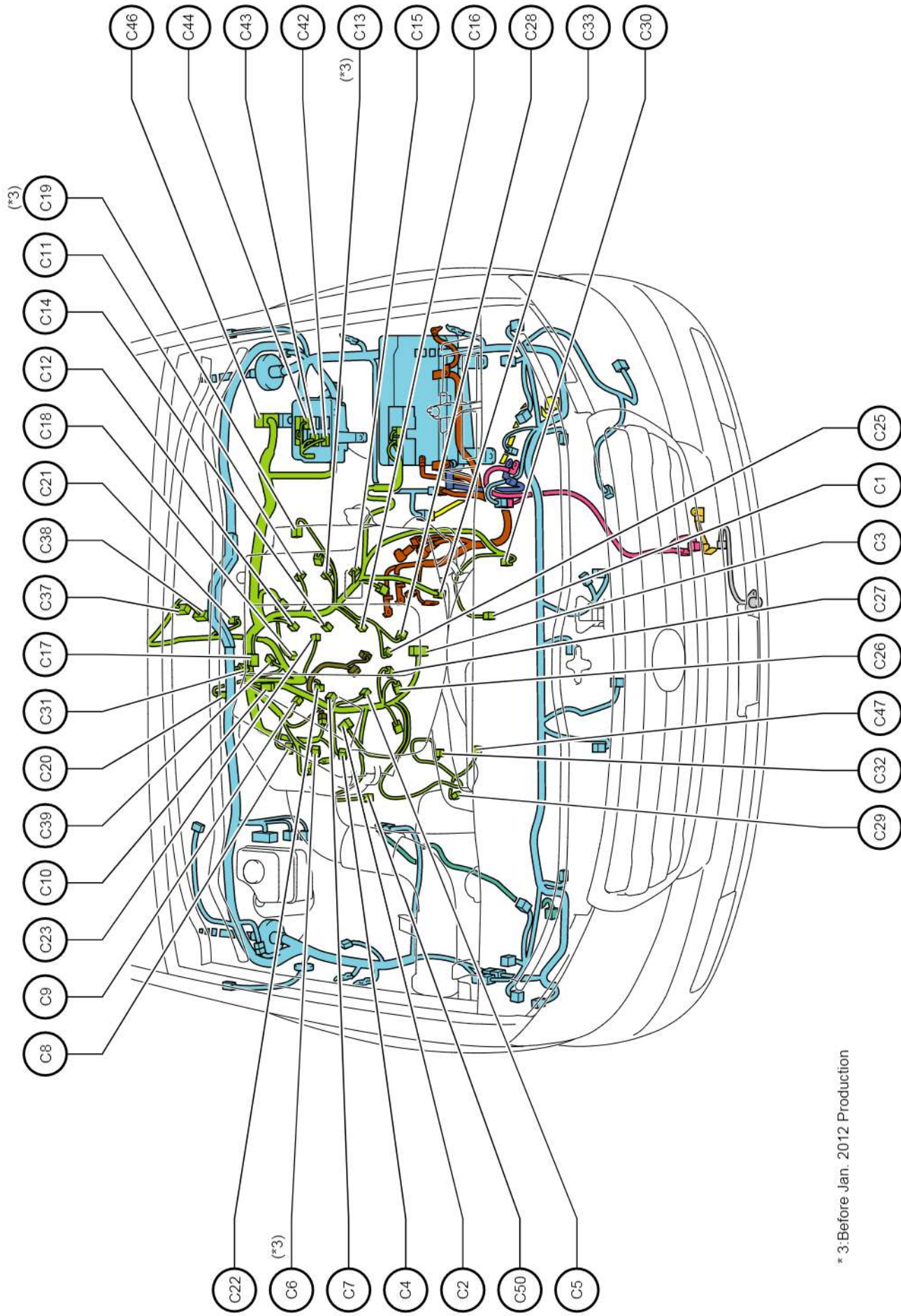

* 3: Before Jan. 2012 Production

C 1	Crankshaft Position Sensor
C 2	Mass Air Flow Meter
C 3	Throttle Body Assembly
C 4	Ignition Coil Assembly No.1
C 5	Fuel Injector Assembly No.1
C 6	Ignition Coil Assembly No.3
C 7	Fuel Injector Assembly No.3
C 8	Ignition Coil Assembly No.5
C 9	Fuel Injector Assembly No.5
C 10	Noise Filter (Ignition Bank 1)
C 11	Ignition Coil Assembly No.6
C 12	Fuel Injector Assembly No.6
C 13	Ignition Coil Assembly No.4
C 14	Fuel Injector Assembly No.4
C 15	Ignition Coil Assembly No.2
C 16	Fuel Injector Assembly No.2
C 17	Noise Filter (Ignition Bank 2)
C 18	E.F.I. Engine Coolant Temperature Sensor
C 19	Purge VSV
C 20	Oxygen Sensor (Bank 1 Sensor 2)
C 21	Oxygen Sensor (Bank 2 Sensor 2)
C 22	Air Fuel Ratio Sensor (Bank 1 Sensor 1)
C 23	Air Fuel Ratio Sensor (Bank 2 Sensor 1)
C 25	WT Sensor (Bank 2 Intake Side)
C 26	WT Sensor (Bank 1 Intake Side)
C 27	Camshaft Timing Oil Control Valve (Bank 1 Intake Side)
C 28	Camshaft Timing Oil Control Valve (Bank 2 Intake Side)
C 29	Power-Steering Oil Pressure Switch
C 30	Cooler Compressor Assembly
C 31	VSV (ACIS)
C 32	Engine Oil Level Sensor
C 33	Oil Pressure Sender Gage Assembly
C 37	Transfer Shift Actuator Assembly
C 38	Transfer Shift Actuator Assembly
C 39	Back-Up Light Switch Assembly
C 42	Junction Connector
C 43	Junction Connector
C 44	Junction Connector
C 46	ECM
C 47	Oil Pressure Sender Gage Assembly
C 50	Mass Air Flow Meter

Position of Parts in Engine Compartment <RHD 1GR-FE>

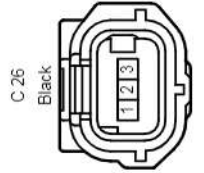
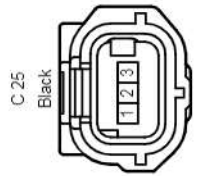
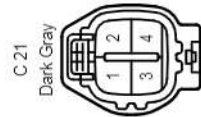
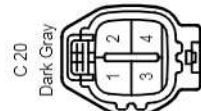
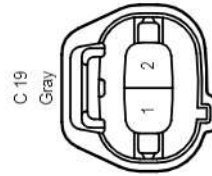
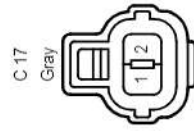
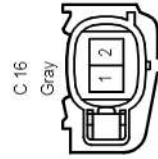
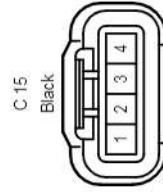
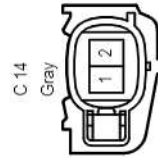
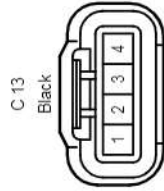
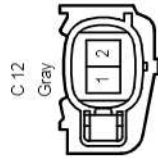
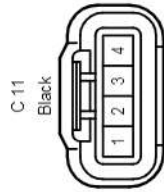
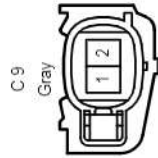
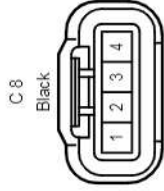
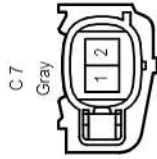
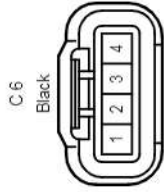
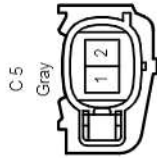
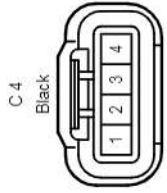
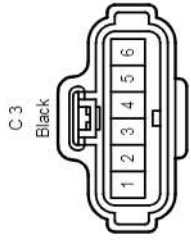
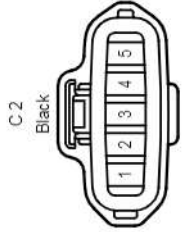
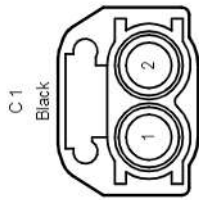

C 30

C 32

C 33

Position of Parts in Engine Compartment <RHD 1GR-FE>

C 42
White

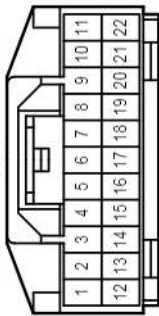

C 43
White

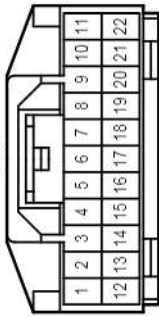

C 44
Blue

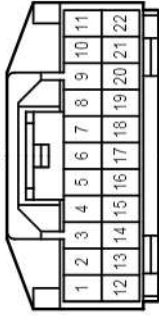

C 46
Black

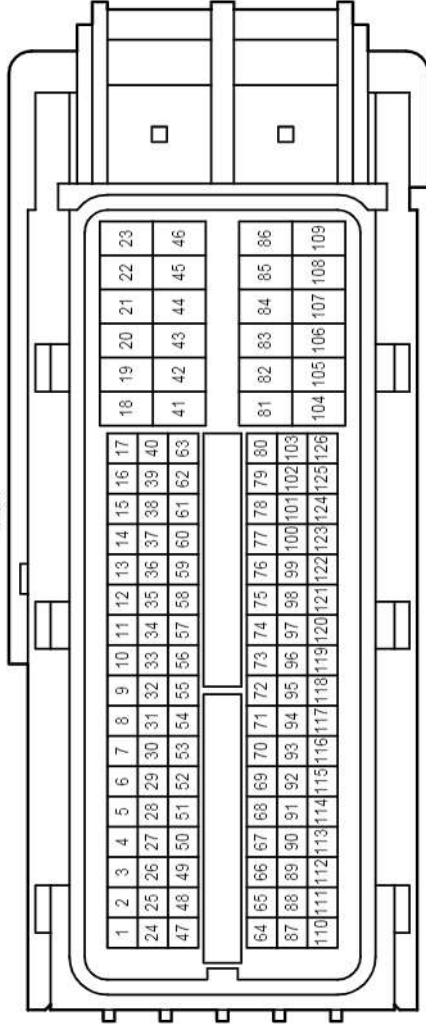

C 47
Black



C 50
Black

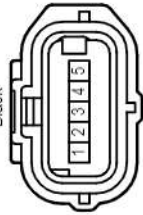

Position of Parts in Engine Compartment <RHD 1GR-FE>

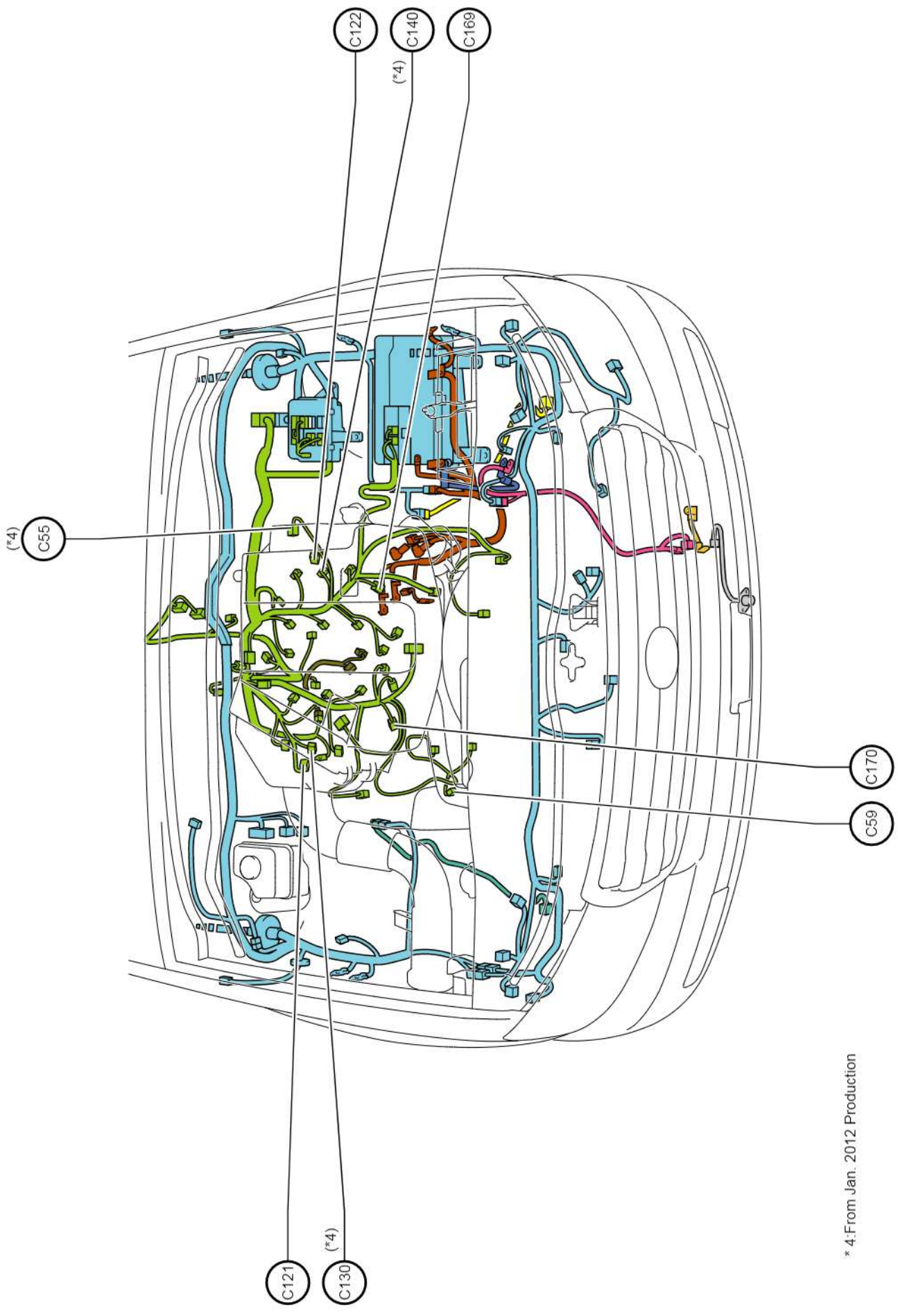

* 4: From Jan. 2012 Production

Position of Parts in Engine Compartment <RHD 1GR-FE>

- C 55 Purge VSV
- C 59 Power Steering Oil Pressure Sensor
- C 121 WT Sensor (Bank 1 Exhaust Side)
- C 122 WT Sensor (Bank 2 Exhaust Side)
- C 130 Ignition Coil Assembly No.3
- C 140 Ignition Coil Assembly No.4
- C 169 Camshaft Timing Oil Control Valve (Bank 1 Exhaust Side)
- C 170 Camshaft Timing Oil Control Valve (Bank 2 Exhaust Side)

Position of Parts in Engine Compartment <RHD 1GR-FE>

C-55
Black

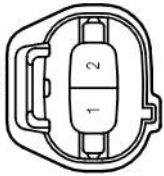

C-59
Gray

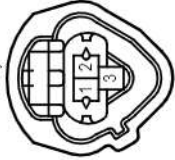

C-121
Black

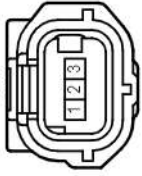

C-122
Black

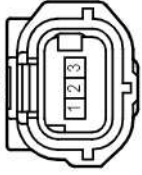

C-130
Gray

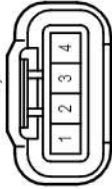

C-140
Gray

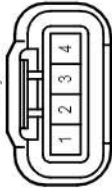

C-169
Gray



C-170
Gray



Position of Parts in Engine Compartment <RHD 1GR-FE>

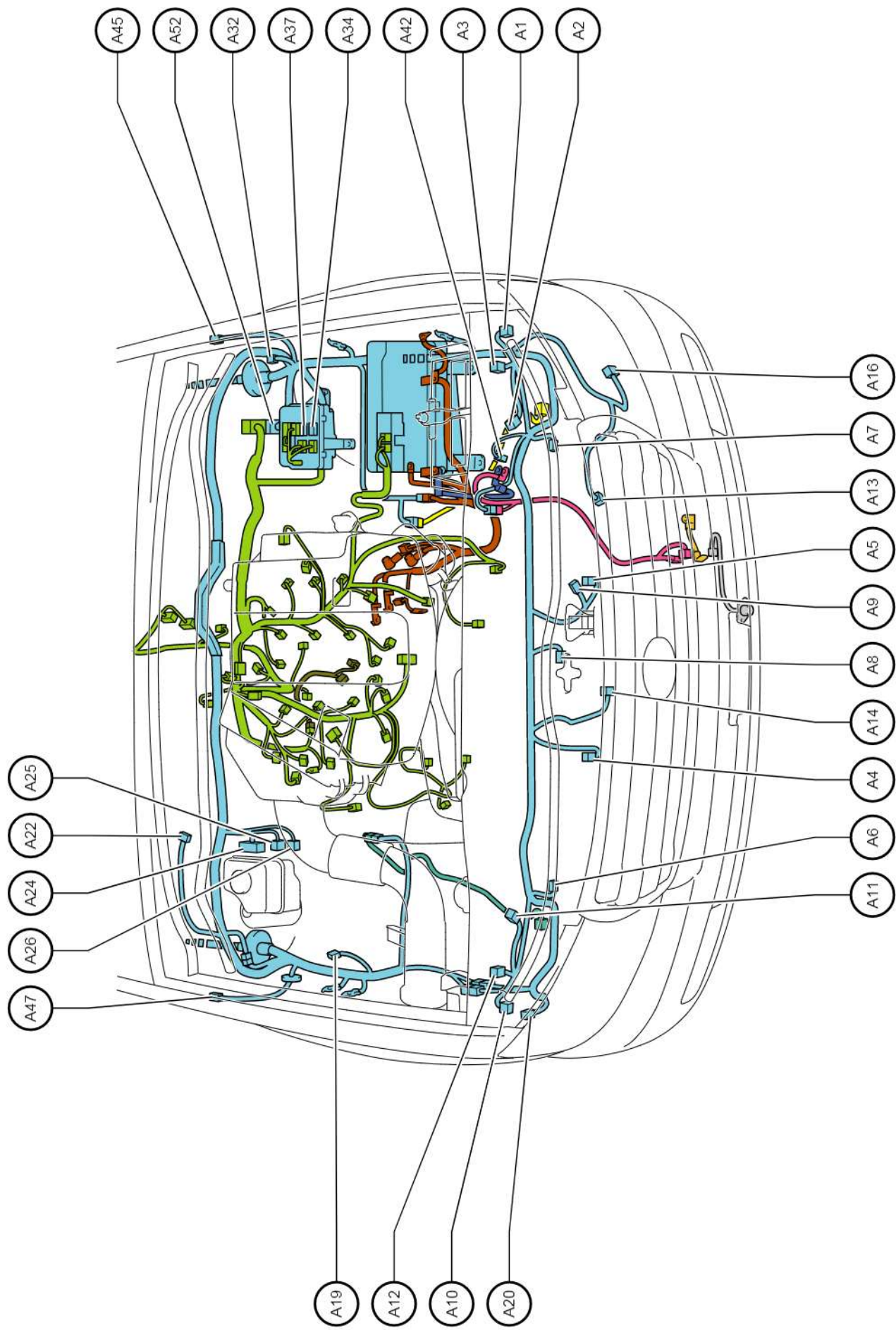

- A 1 Headlight Assembly LH
- A 2 Headlight Assembly LH
- A 3 Headlight Assembly LH
- A 4 High Pitched Horn Assembly
- A 5 Low Pitched Horn Assembly
- A 6 Front Airbag Sensor RH
- A 7 Front Airbag Sensor LH
- A 8 Engine Hood Courtesy Switch
- A 8 Engine Hood Courtesy Switch
- A 9 Condenser Blower Motor Assembly
- A 10 Headlight Assembly RH
- A 11 Headlight Assembly RH
- A 12 Headlight Assembly RH
- A 13 A/C Pressure Sensor
- A 14 Ambient Temperature Sensor
- A 16 Windshield Washer Motor and Pump Assembly
- A 19 Security Horn Assembly
- A 20 Wireless Door Lock Buzzer
- A 22 Windshield Wiper Motor Assembly
- A 24 Skid Control ECU with Actuator Assembly
- A 25 Skid Control ECU with Actuator Assembly
- A 26 Brake Fluid Level Warning Switch (Brake Master Cylinder Reservoir Assembly)
- A 32 Noise Filter
- A 34 Junction Connector
- A 37 Junction Connector
- A 42 Winch Main Relay (No.1 Magnet Switch Assembly)
- A 45 Side Turn Signal Light Assembly LH
- A 47 Side Turn Signal Light Assembly RH
- A 52 ECM

Position of Parts in Engine Compartment <RHD 1GR-FE>

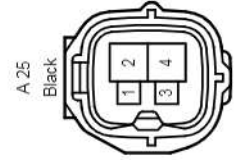
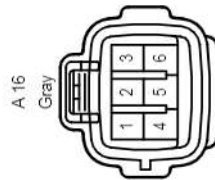
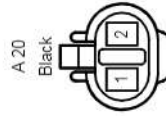
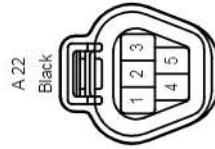
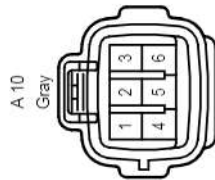
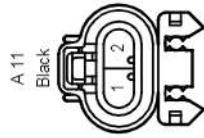
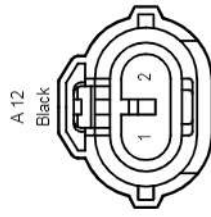
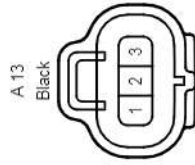
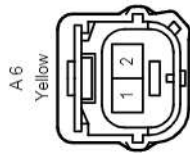
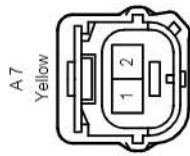
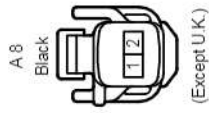
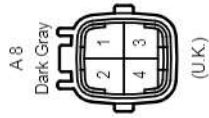
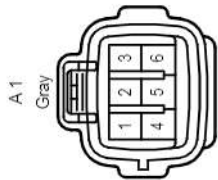
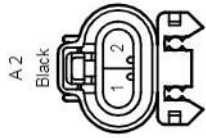
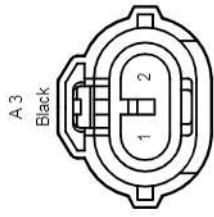

A 24
Black

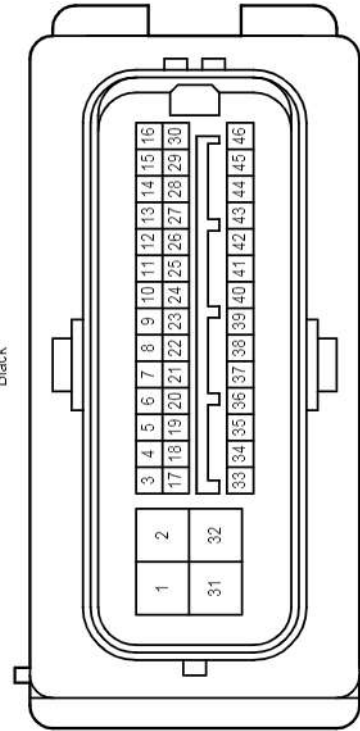

Position of Parts in Engine Compartment <RHD 1GR-FE>

A 37
Blue

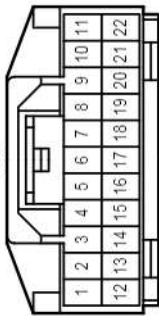

A 42
Black



A 45
Gray



A 47
Gray



A 52
Black

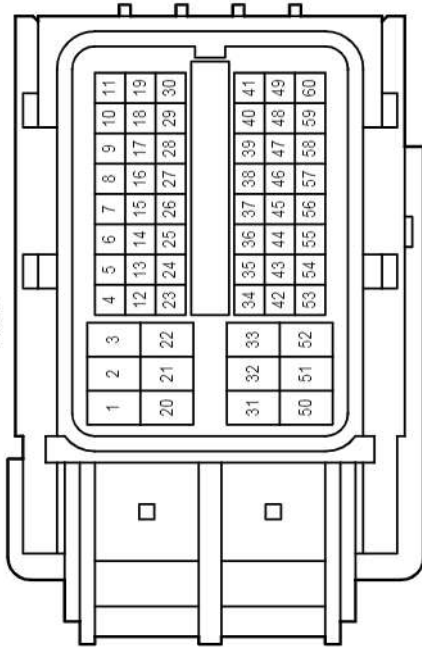

Position of Parts in Engine Compartment <RHD 1GR-FE>

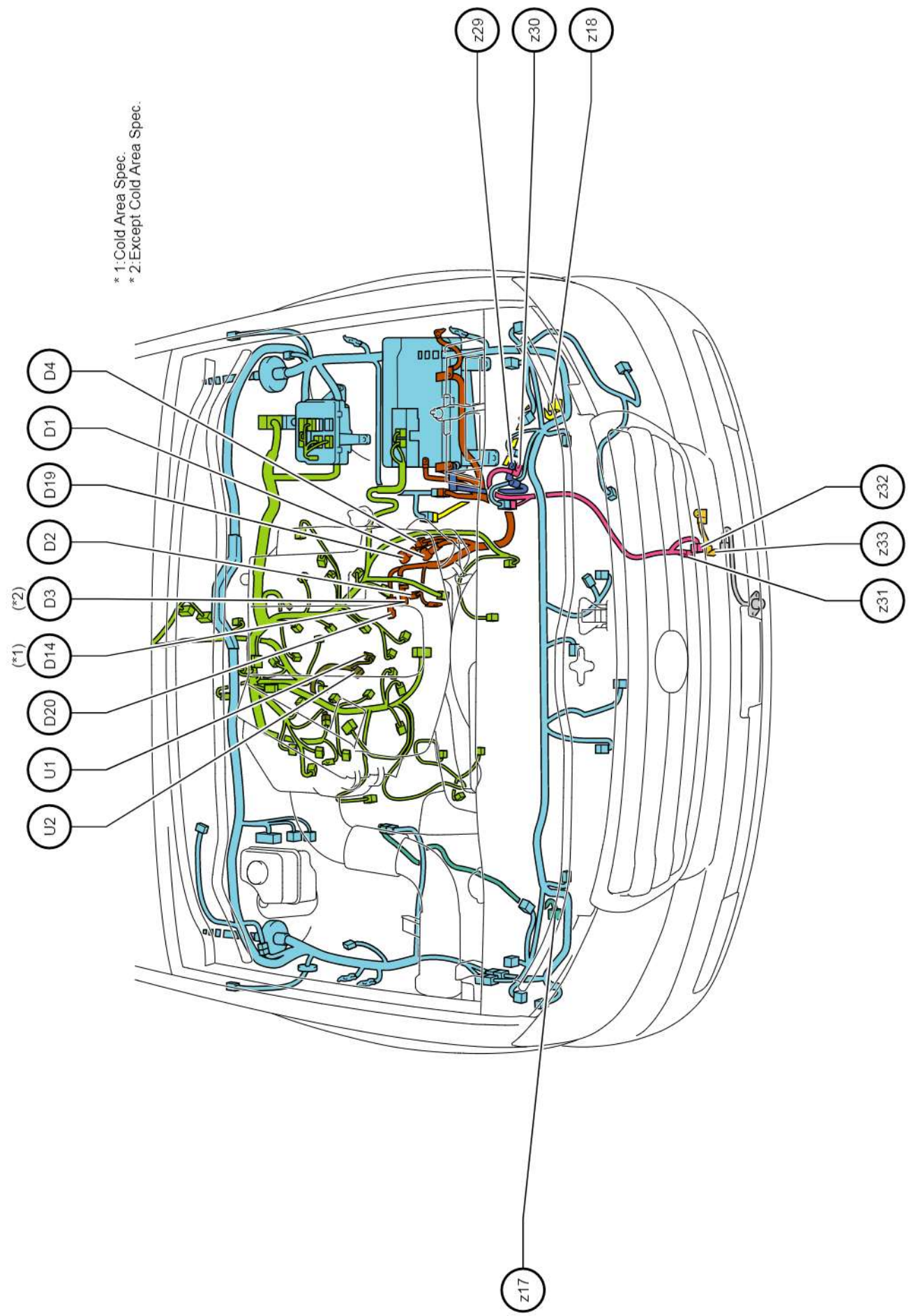

* 1: Cold Area Spec.
* 2: Except Cold Area Spec.

- D 1 Generator Assembly
- D 2 Starter Assembly
- D 3 Starter Assembly
- D 4 Generator Assembly
- D 14 Starter Assembly
- D 19 Generator Assembly
- D 20 Starter Assembly

- U 1 Knock Control Sensor (Bank 2)
- U 2 Knock Control Sensor (Bank 1)

- Z 17 Front Speed Sensor RH
- Z 18 Front Speed Sensor LH
- Z 29 Winch Main Relay (No.1 Magnet Switch Assembly)
- Z 30 Winch Main Relay (No.1 Magnet Switch Assembly)
- Z 31 With Magnet Switch Winch Motor Assembly
- Z 32 With Magnet Switch Winch Motor Assembly
- Z 33 With Magnet Switch Winch Motor Assembly

Position of Parts in Engine Compartment <RHD 1GR-FE>

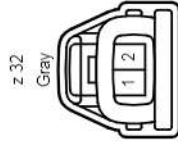
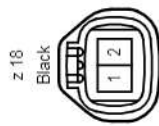
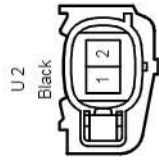
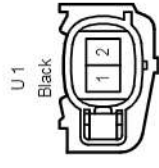
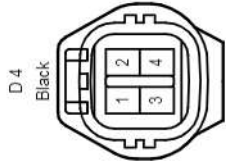
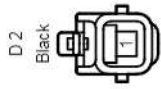

* 1:Lifftgate Type Body
* 2:Swing Type Body

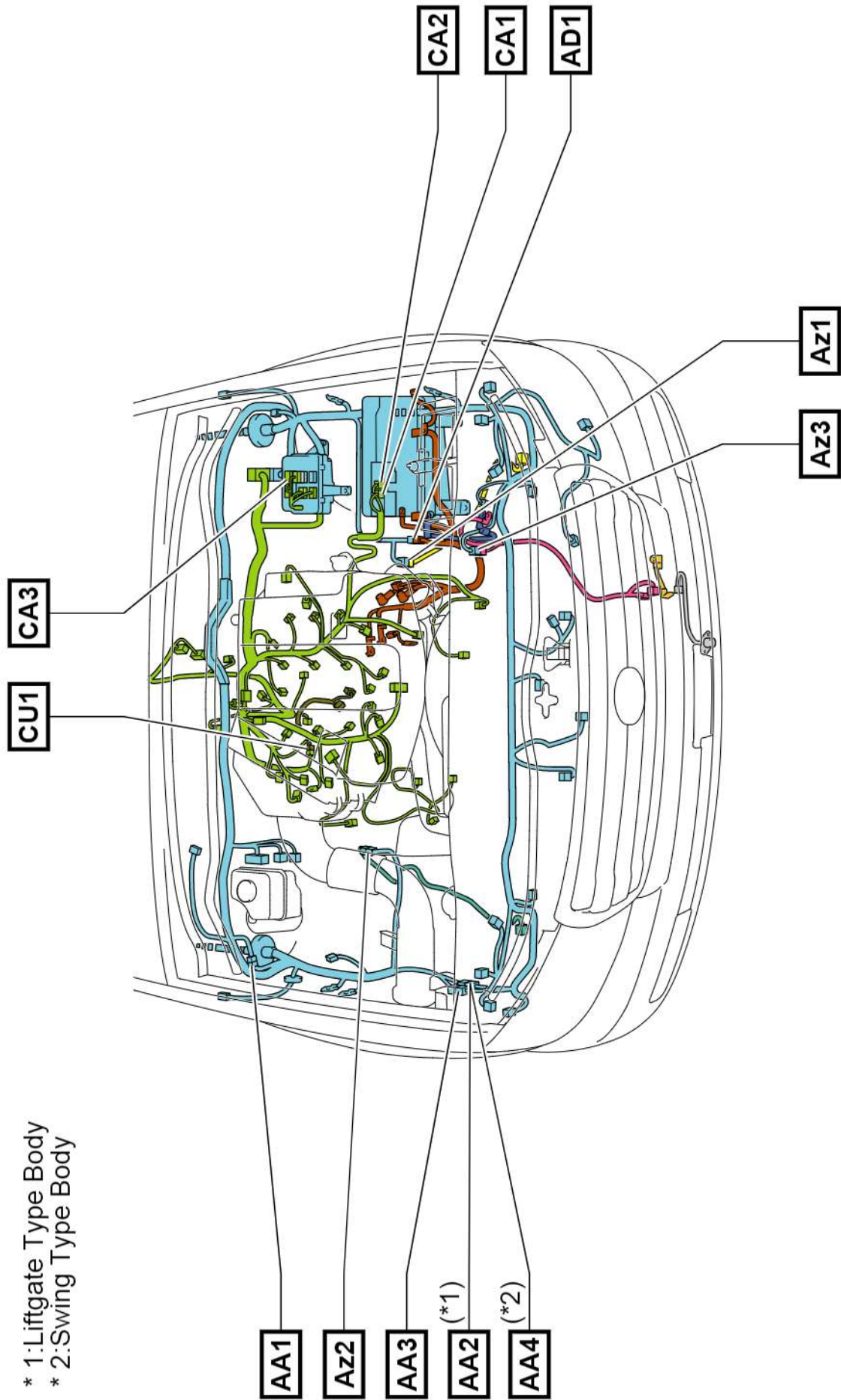

Wire and Wire in Engine Compartment <RHD 1GR-FE>

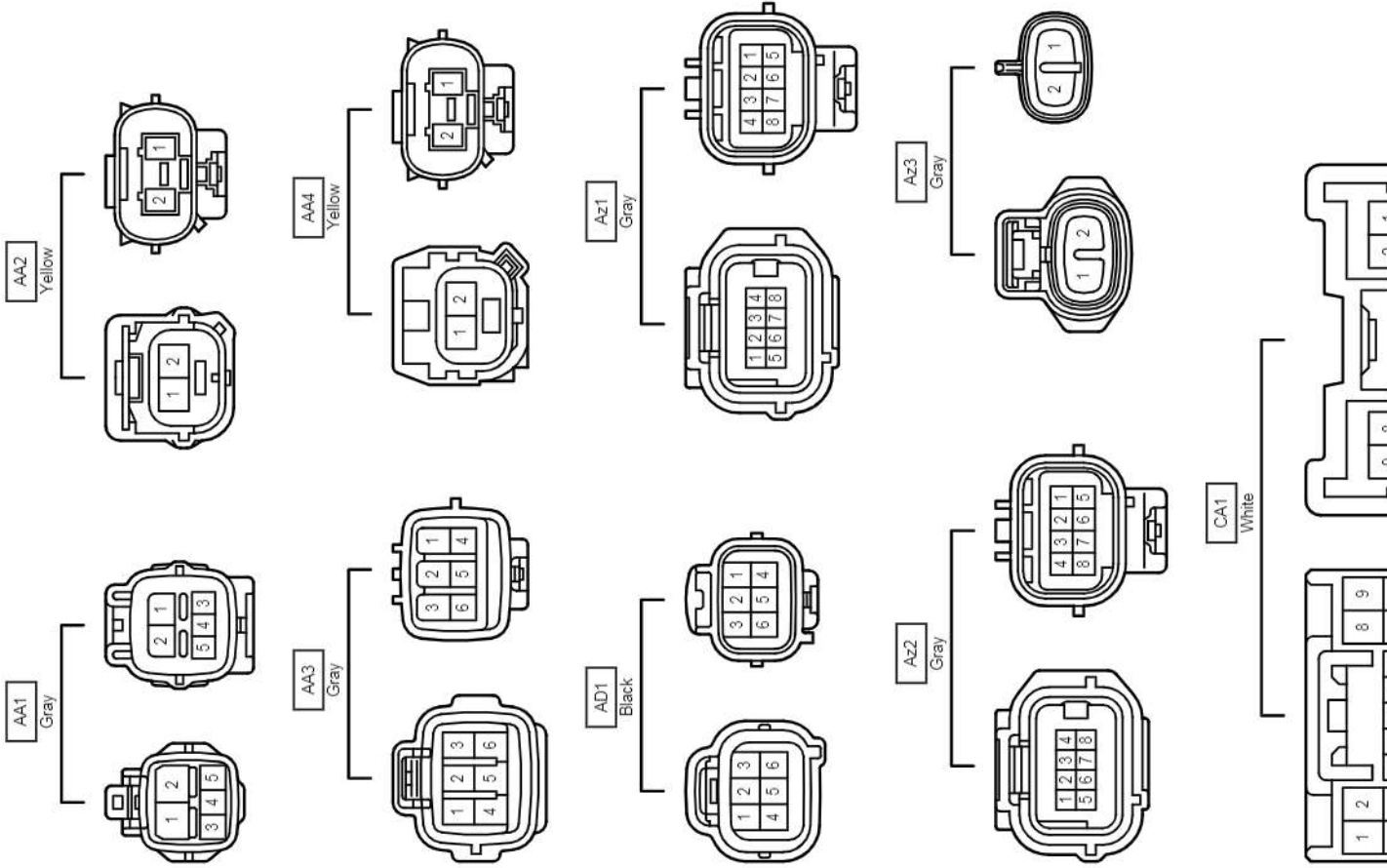

Wire and Wire in Engine Compartment <RHD 1GR-FE>

CA2
White

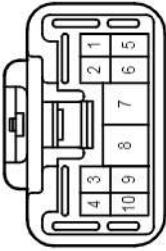
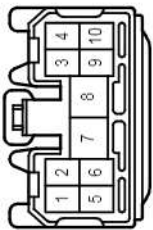

CA3
White

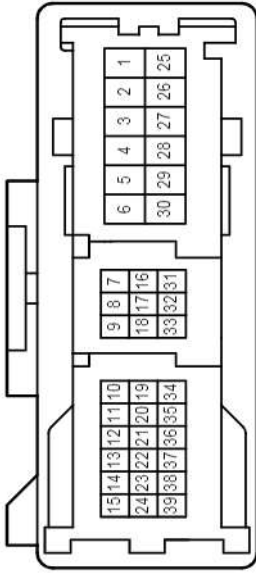
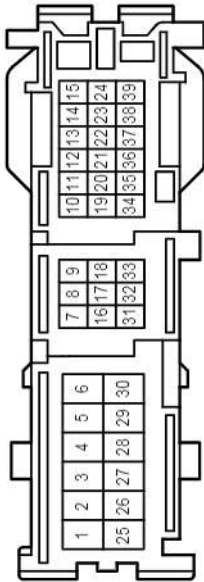

CU1

Black



Dark Gray

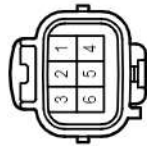

Ground Points in Engine Compartment <LHD 1UR-FE>

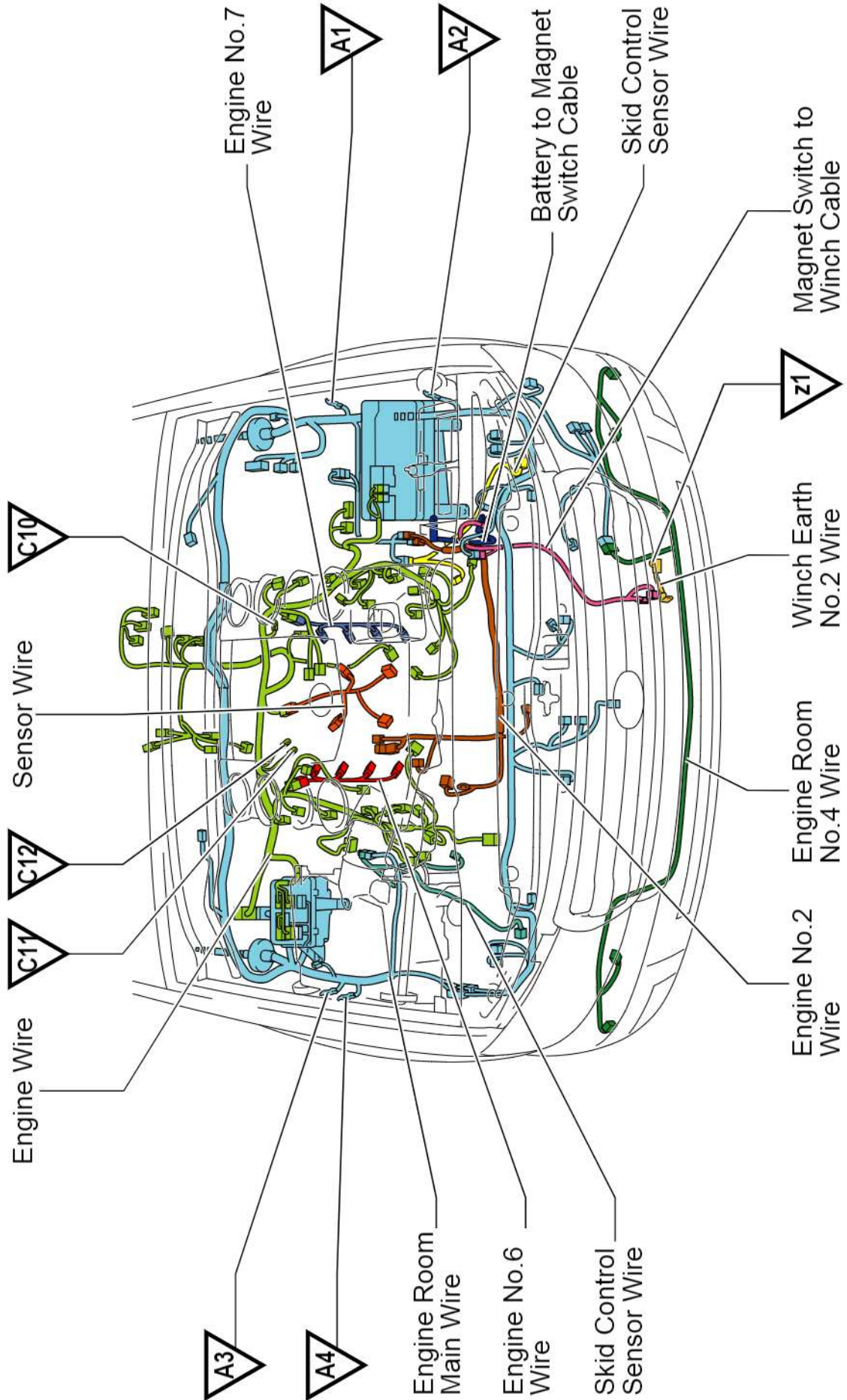

C 3	Throttle Body Assembly
C 4	Ignition Coil Assembly No.1
C 8	Ignition Coil Assembly No.5
C 13	Ignition Coil Assembly No.4
C 18	E.F.I. Engine Coolant Temperature Sensor
C 20	Oxygen Sensor (Bank 1 Sensor 2)
C 22	Air Fuel Ratio Sensor (Bank 1 Sensor 1)
C 23	Air Fuel Ratio Sensor (Bank 2 Sensor 1)
C 24	Park/Neutral Position Switch
C 30	Cooler Compressor Assembly
C 34	Electronically Controlled Transmission Solenoid
C 35	Transmission Revolution Sensor (Turbine)
C 36	Transmission Revolution Sensor (Counter Gear)
C 37	Transfer Shift Actuator Assembly
C 38	Transfer Shift Actuator Assembly
C 42	Junction Connector
C 43	Junction Connector
C 44	Junction Connector
C 45	ECM
C 50	Mass Air Flow Meter
C 53	Ignition Coil Assembly No.8
C 55	Purge VSV
C 56	Oxygen Sensor (Bank 2 Sensor 2)
C 59	Power Steering Oil Pressure Sensor
C 60	Air Injection Control Driver
C 61	Air Injection Control Driver
C 96	Electronically Controlled Transmission Solenoid
C 97	Transfer Shift Actuator Assembly
C 99	Camshaft Position Sensor
C 100	WT Sensor (Bank 1 Intake Side)
C 101	WT Sensor (Bank 2 Intake Side)
C 102	Camshaft Timing Oil Control Valve (Bank 1 Intake Side)
C 103	Camshaft Timing Oil Control Valve (Bank 2 Intake Side)
C 114	Crankshaft Position Sensor
C 121	WT Sensor (Bank 1 Exhaust Side)
C 122	WT Sensor (Bank 2 Exhaust Side)
C 125	Camshaft Timing Oil Control Valve (Bank 1 Exhaust Side)
C 126	Camshaft Timing Oil Control Valve (Bank 2 Exhaust Side)
C 129	VSV (ACIS)
C 130	Ignition Coil Assembly No.3
C 131	Ignition Coil Assembly No.7
C 132	Noise Filter (Ignition Bank 1)
C 133	Ignition Coil Assembly No.6
C 134	Ignition Coil Assembly No.2

Position of Parts in Engine Compartment <LHD 1UR-FE>

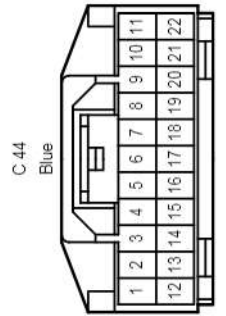
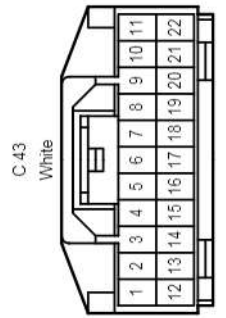
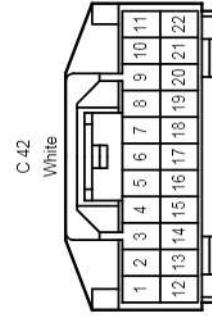
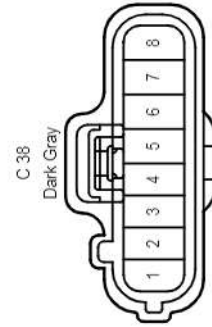
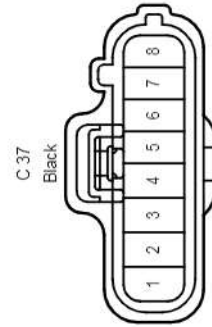
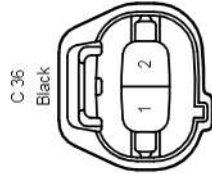
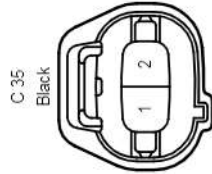
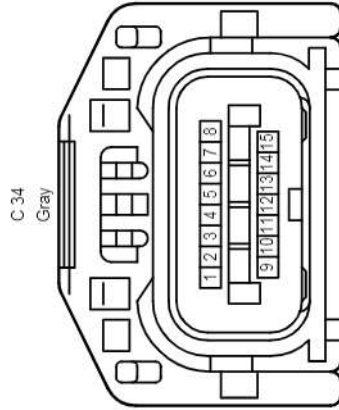
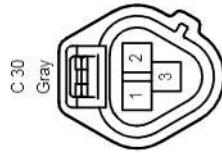
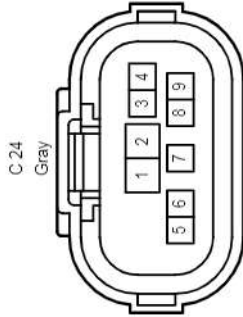
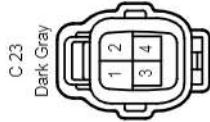
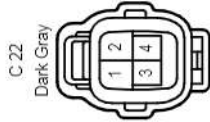
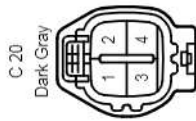
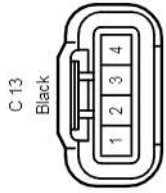
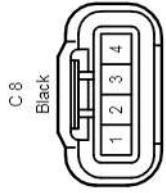
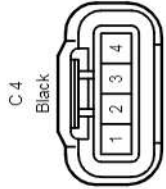
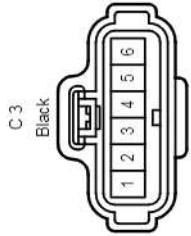

cardiagn.com

Position of Parts in Engine Compartment <LHD 1UR-FE>

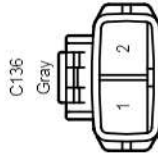
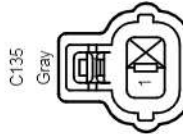
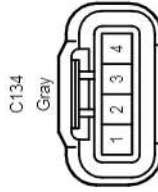
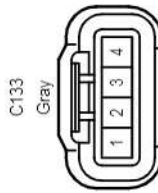
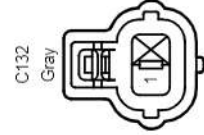
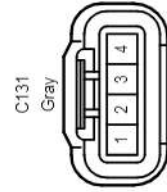
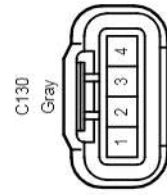
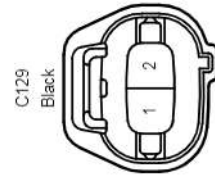
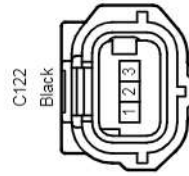
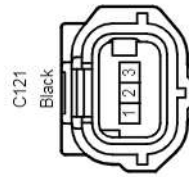
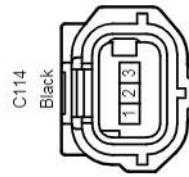
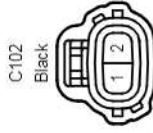
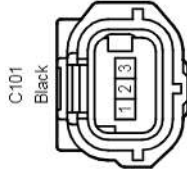
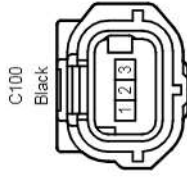
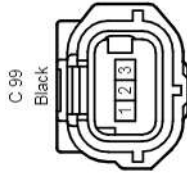
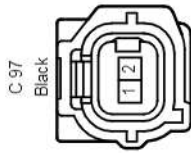
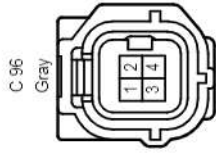
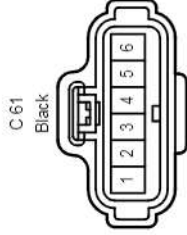
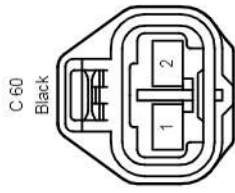
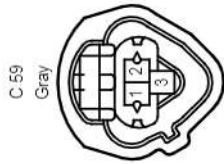
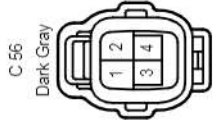
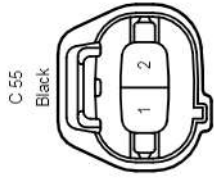
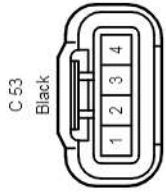
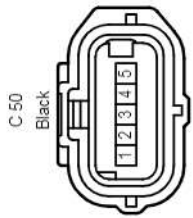

Position of Parts in Engine Compartment <LHD 1UR-FE>

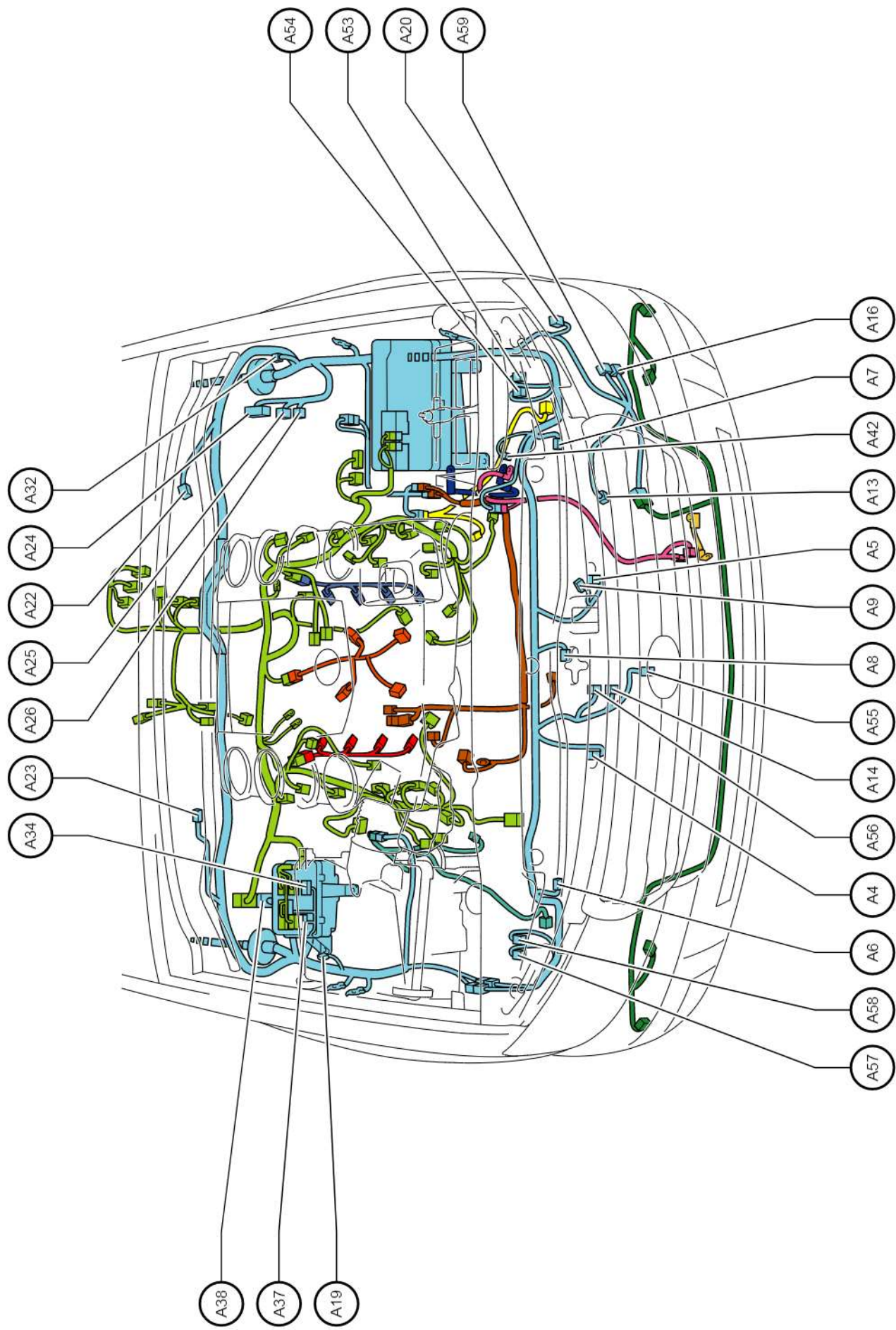

- A 4 High Pitched Horn Assembly
- A 5 Low Pitched Horn Assembly
- A 6 Front Airbag Sensor RH
- A 7 Front Airbag Sensor LH
- A 8 Engine Hood Courtesy Switch
- A 9 Condenser Blower Motor Assembly
- A 13 A/C Pressure Sensor
- A 14 Ambient Temperature Sensor
- A 16 Windshield Washer Motor and Pump Assembly
- A 19 Security Horn Assembly
- A 20 Wireless Door Lock Buzzer
- A 22 Windshield Wiper Motor Assembly
- A 23 Front Wiper Deicer (Windshield Glass)
- A 24 Skid Control ECU with Actuator Assembly
- A 25 Skid Control ECU with Actuator Assembly
- A 26 Brake Fluid Level Warning Switch (Brake Master Cylinder Reservoir Assembly)
- A 32 Noise Filter
- A 34 Junction Connector
- A 37 Junction Connector
- A 38 ECM
- A 42 Winch Main Relay (No.1 Magnet Switch Assembly)
- A 53 Headlight Assembly LH
- A 54 Headlight Assembly LH
- A 55 Front Television Camera Assembly
- A 56 Millimeter Wave Radar Sensor Assembly
- A 57 Headlight Assembly RH
- A 58 Headlight Assembly RH
- A 59 Headlight Cleaner Control Relay and Motor

Position of Parts in Engine Compartment <LHD 1UR-FE>

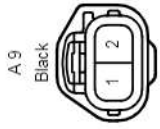

A 9
Black



A 8
Black

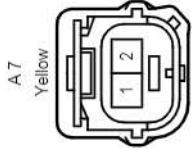

A 7
Yellow

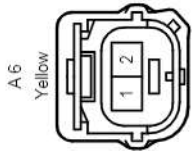

A 6
Yellow



A 5
Black



A 4
Black

(Except U.K.)

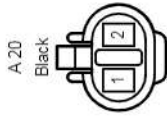

A 20
Black



A 19
Black

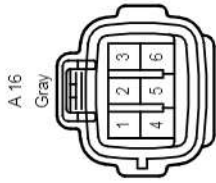

A 16
Gray



A 14
Black

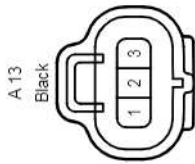

A 13
Black

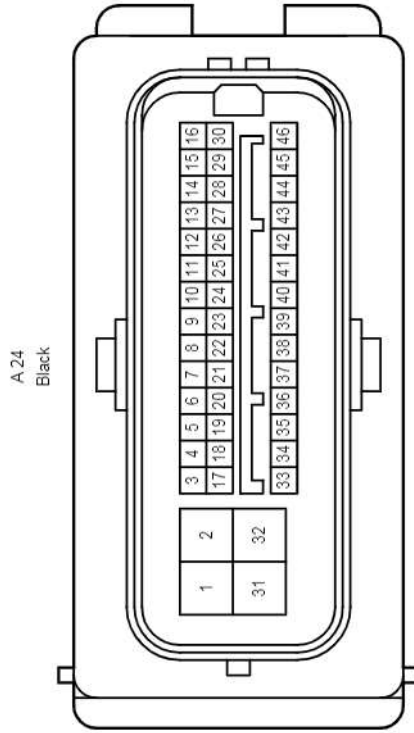

A 24
Black



A 23
Gray

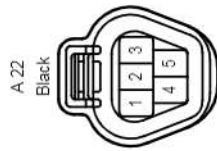

A 22
Black

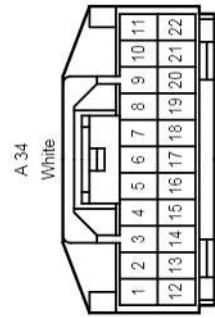

A 34
White

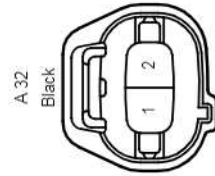

A 32
Black

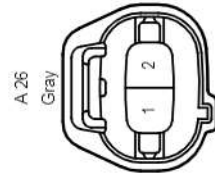

A 26
Gray

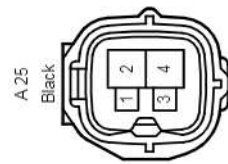

A 25
Black

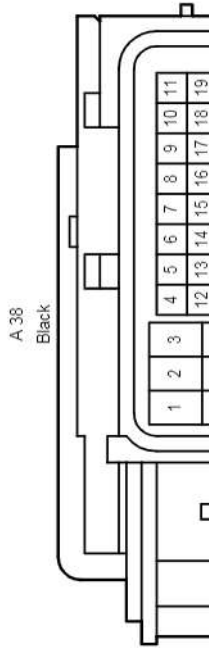

A 38
Black

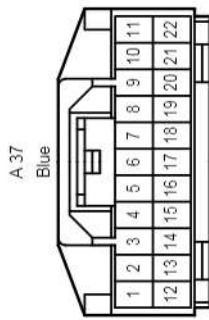

A 37
Blue

Position of Parts in Engine Compartment <LHD 1UR-FE>

A 42
Black

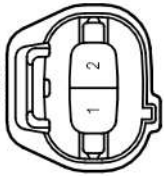

A 53
Black



A 54
Black

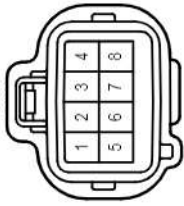

A 55
Black

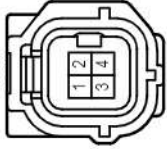

A 56
Black

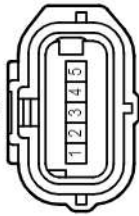

A 57
Black



A 58
Black

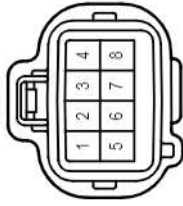

A 59
White



Position of Parts in Engine Compartment <LHD 1UR-FE>

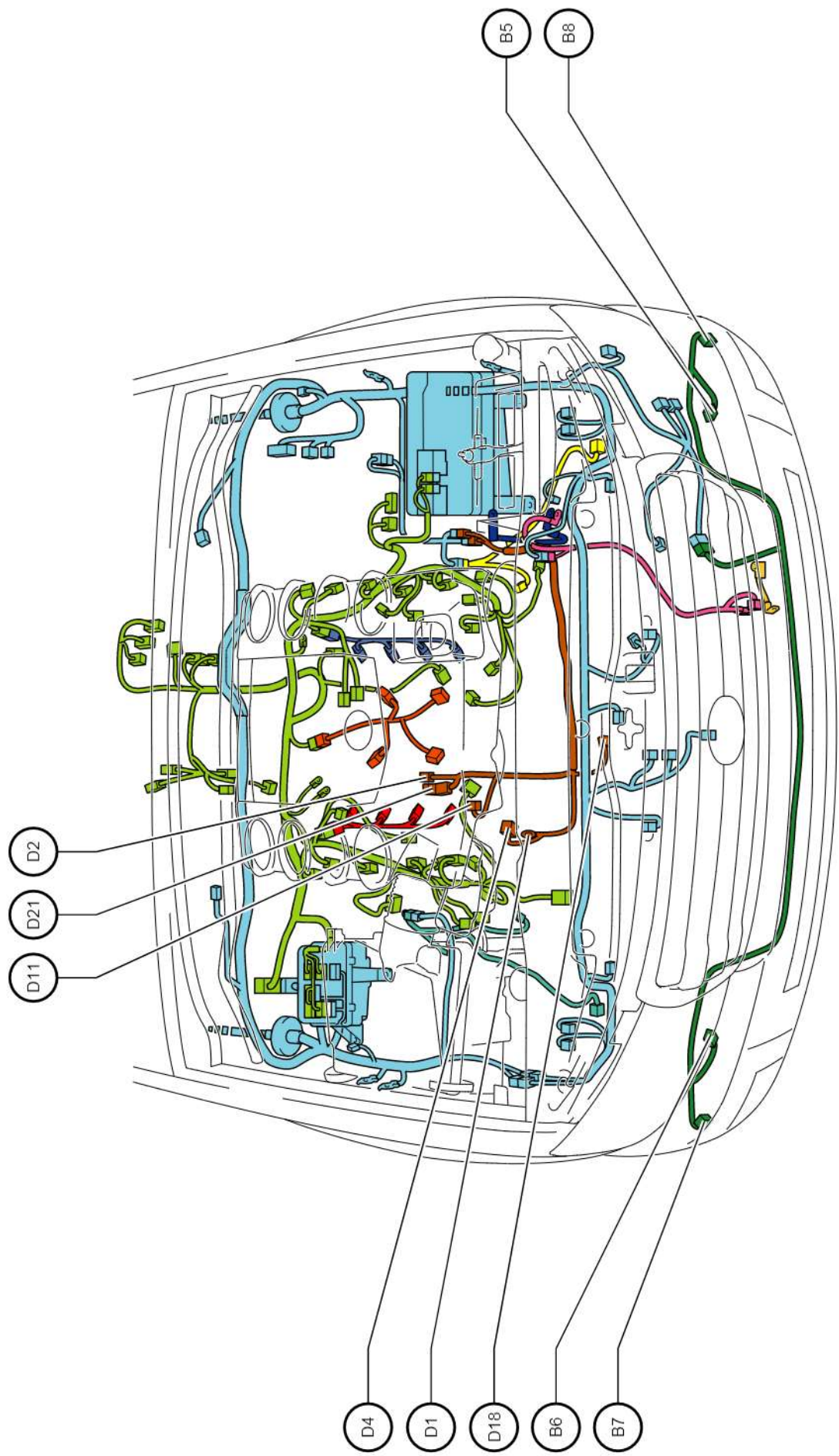

Position of Parts in Engine Compartment <LHD 1UR-FE>

- B 5 Fog Light Assembly LH
- B 6 Fog Light Assembly RH
- B 7 No.1 Ultrasonic Sensor RH
- B 8 No.1 Ultrasonic Sensor LH

- D 1 Generator Assembly
- D 2 Starter Assembly
- D 4 Generator Assembly
- D 11 Engine Oil Level Sensor
- D 18 Oil Pressure Sender Gage Assembly
- D 21 Starter Assembly

Position of Parts in Engine Compartment <LHD 1UR-FE>

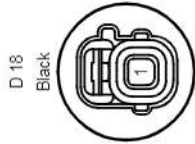
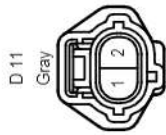
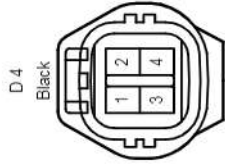
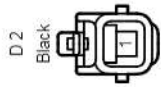
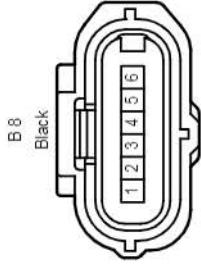
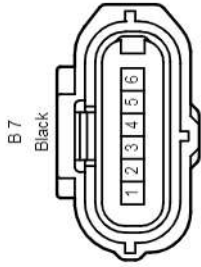
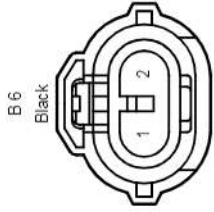
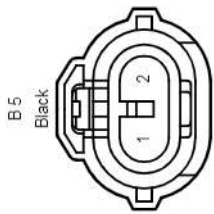

Position of Parts in Engine Compartment <LHD 1UR-FE>

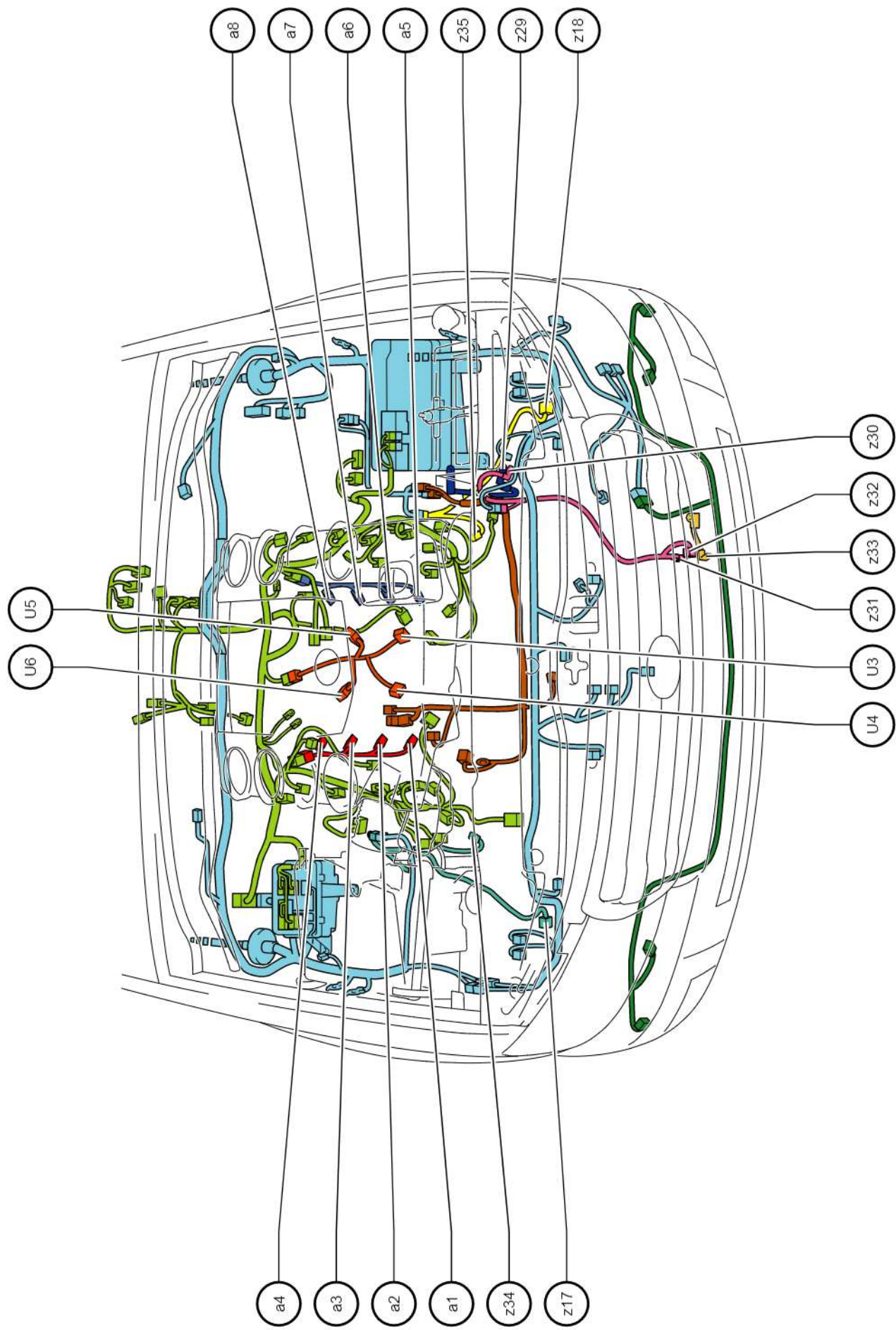

- U 3 Knock Control Sensor (Bank 1 Sensor 1)
- U 4 Knock Control Sensor (Bank 2 Sensor 1)
- U 5 Knock Control Sensor (Bank 1 Sensor 2)
- U 6 Knock Control Sensor (Bank 2 Sensor 2)

- a 1 Fuel Injector Assembly No.2
- a 2 Fuel Injector Assembly No.4
- a 3 Fuel Injector Assembly No.6
- a 4 Fuel Injector Assembly No.8
- a 5 Fuel Injector Assembly No.1
- a 6 Fuel Injector Assembly No.3
- a 7 Fuel Injector Assembly No.5
- a 8 Fuel Injector Assembly No.7

- z 17 Front Speed Sensor RH
- z 18 Front Speed Sensor LH
- z 29 Winch Main Relay (No.1 Magnet Switch Assembly)
- z 30 Winch Main Relay (No.1 Magnet Switch Assembly)
- z 31 With Magnet Switch Winch Motor Assembly
- z 32 With Magnet Switch Winch Motor Assembly
- z 33 With Magnet Switch Winch Motor Assembly
- z 34 Front Height Control Sensor Sub-Assembly RH
- z 35 Front Height Control Sensor Sub-Assembly LH

Position of Parts in Engine Compartment <LHD 1UR-FE>

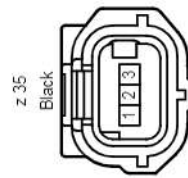
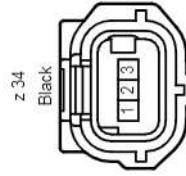
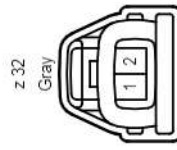
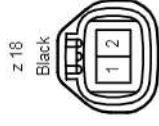
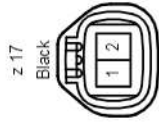
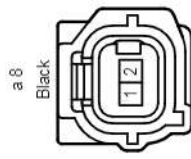
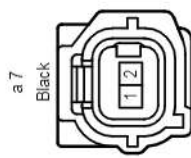
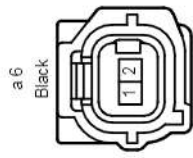
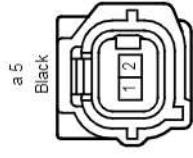
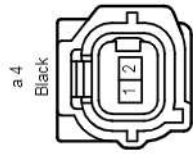
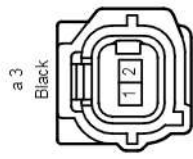
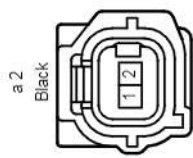
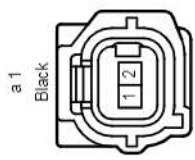
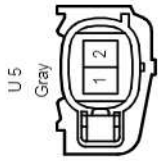
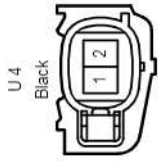
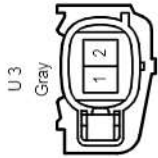

Wire and Wire in Engine Compartment <LHD 1UR-FE>

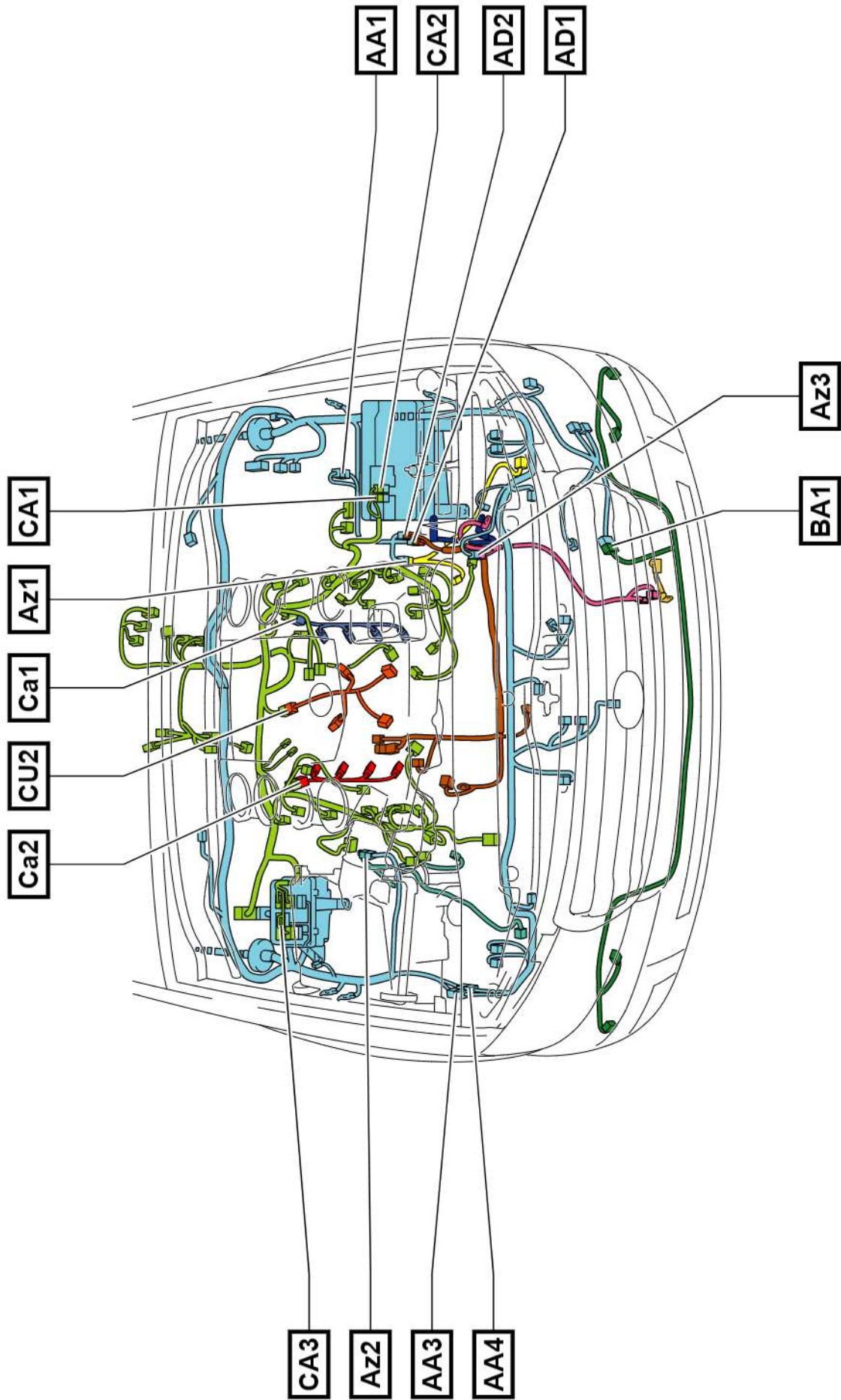

Wire and Wire in Engine Compartment <LHD 1UR-FE>

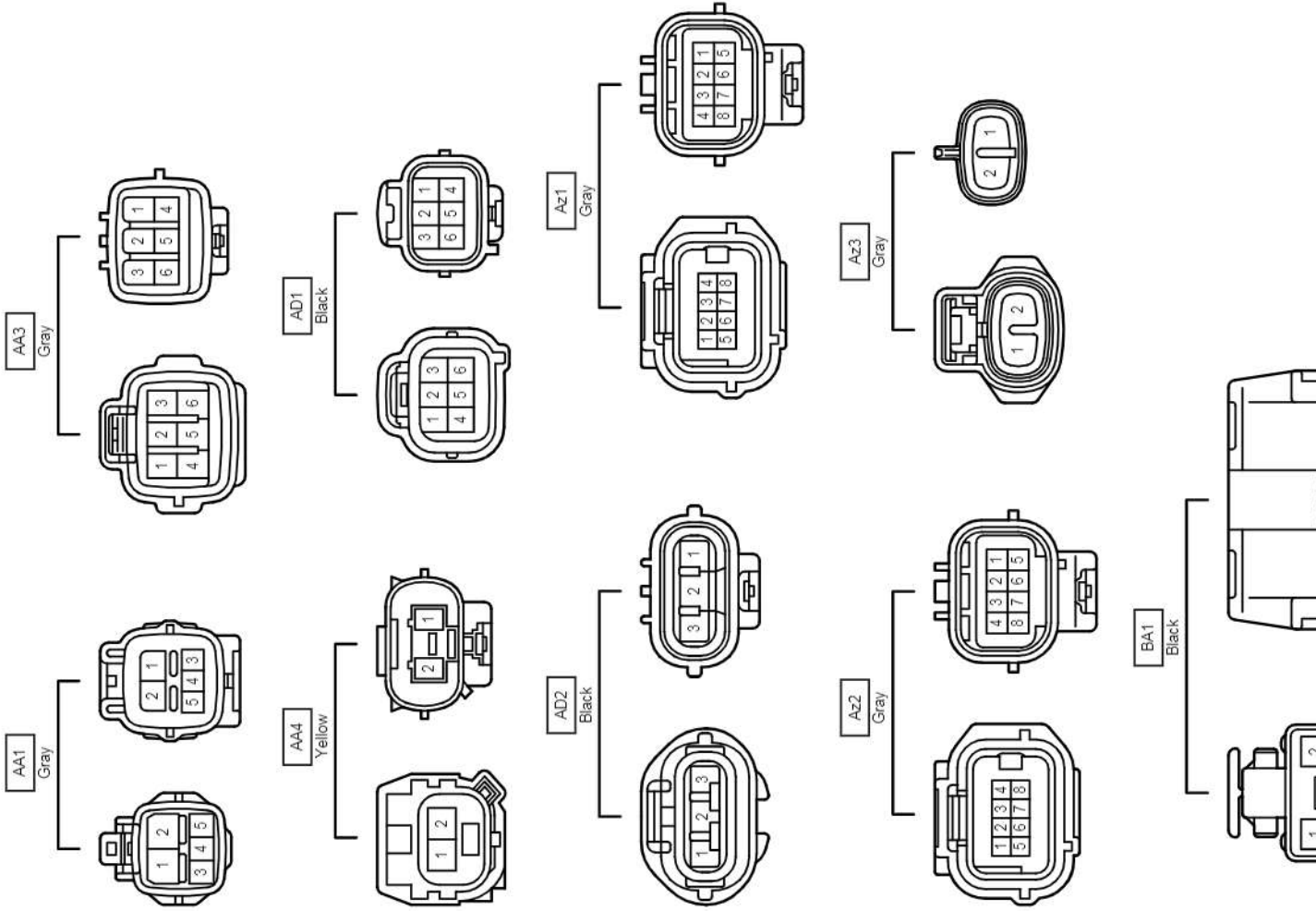

Wire and Wire in Engine Compartment <LHD 1UR-FE>

CA1
White

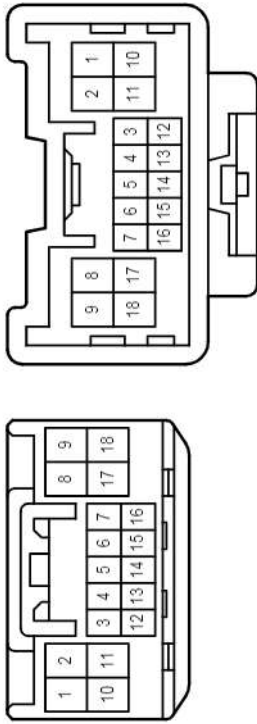

CA2
White

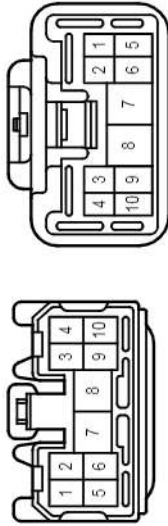

CA3
White

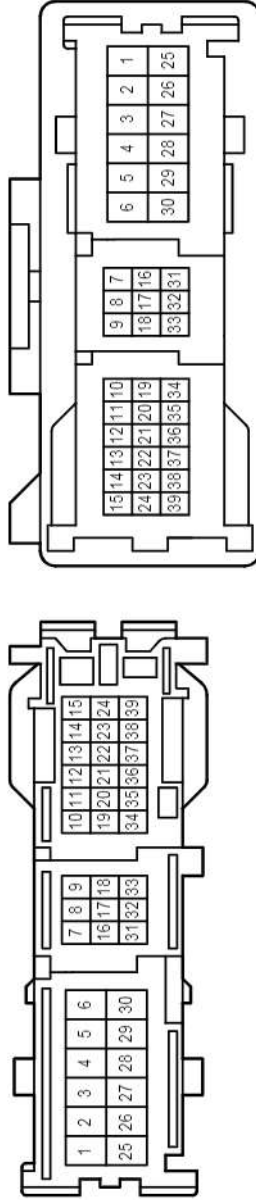

CU2
Gray

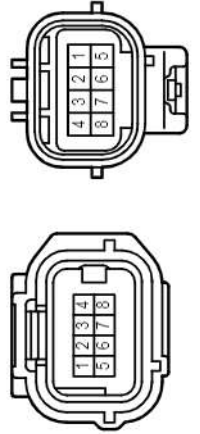

CA1
Gray

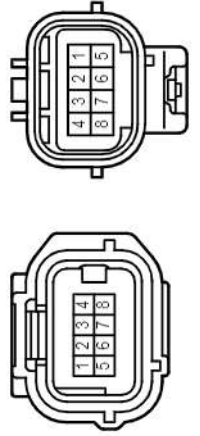

Ground Points in Engine Compartment <RHD 1UR-FE>

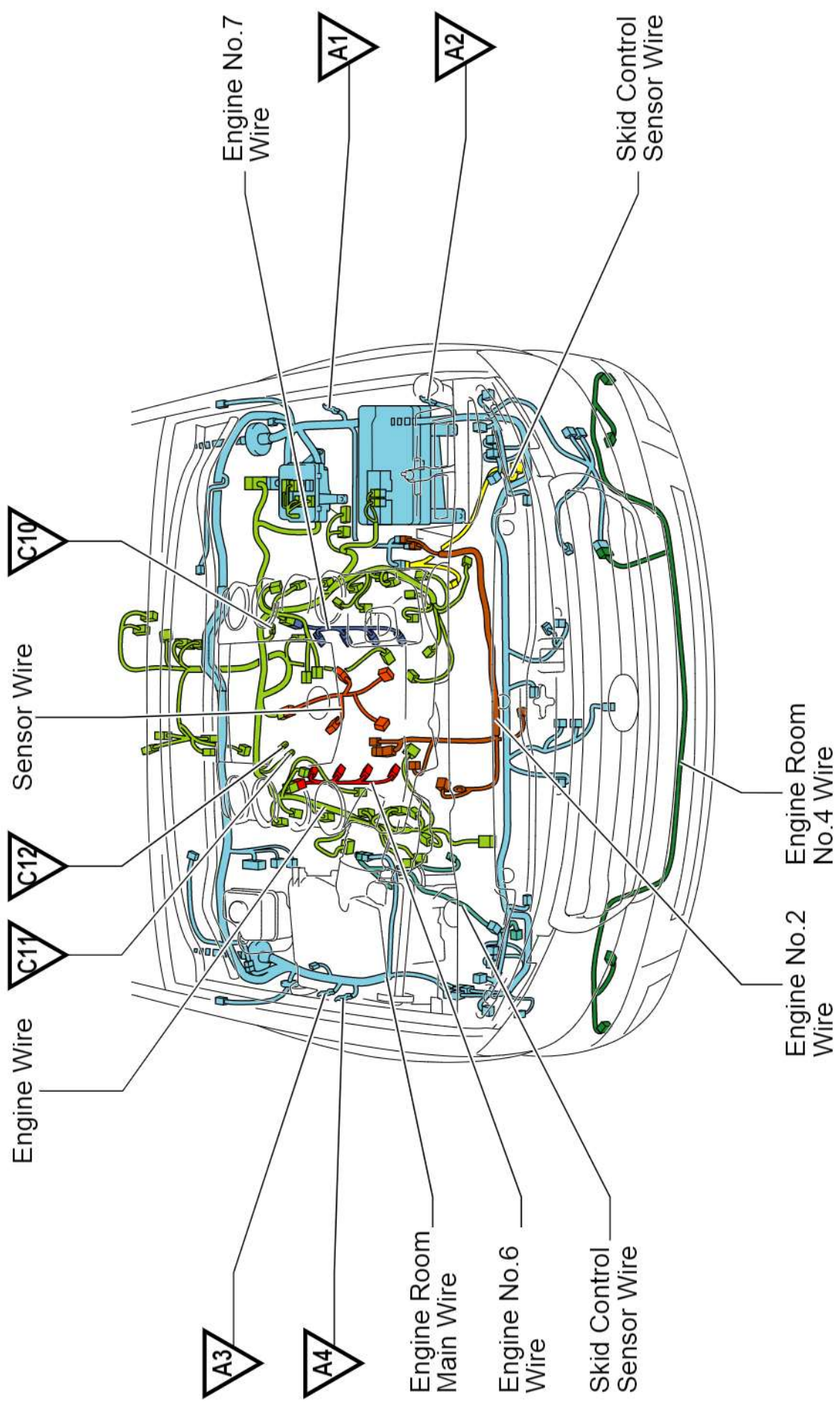

Position of Parts in Engine Compartment <RHD 1UR-FE>

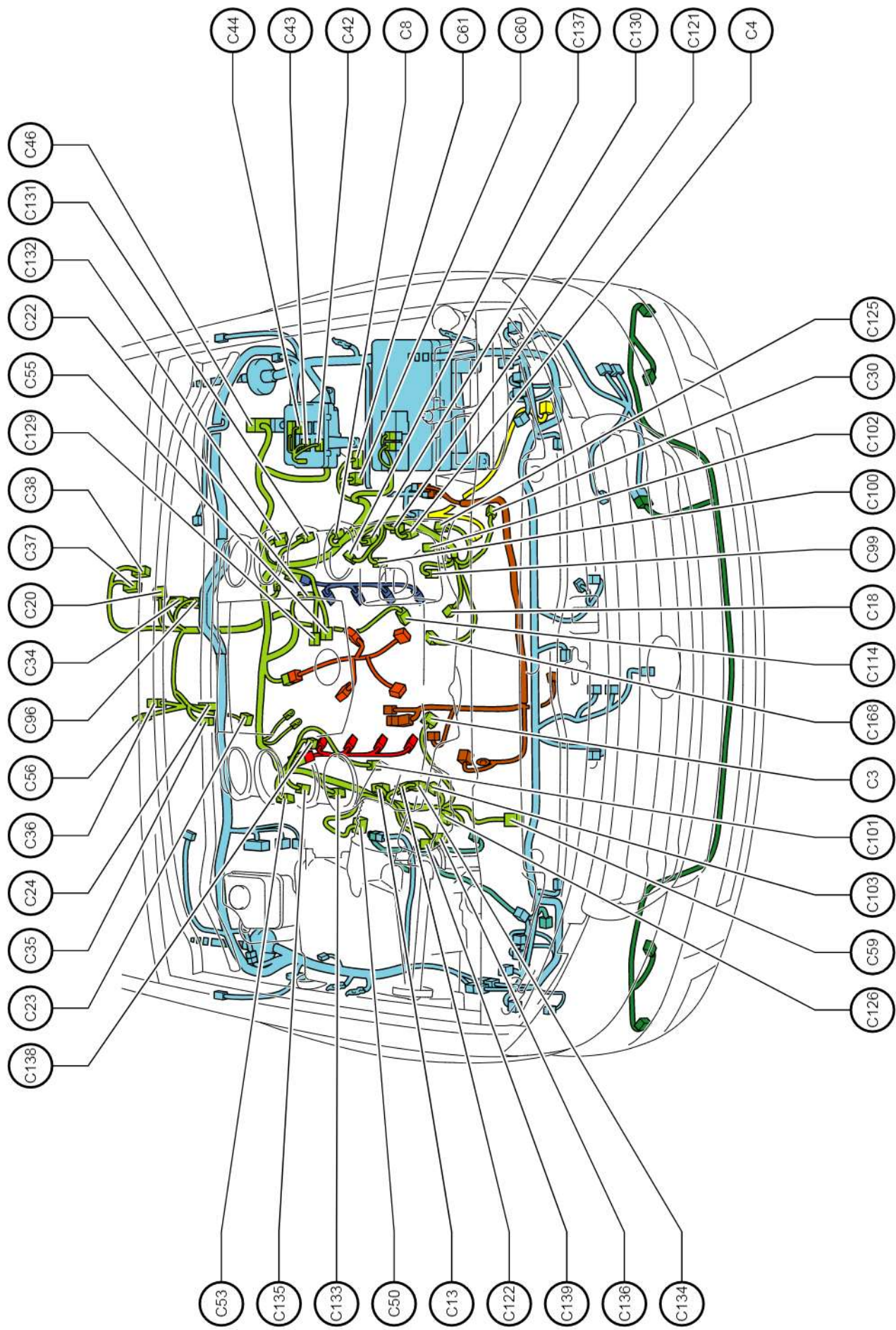

C 3	Throttle Body Assembly
C 4	Ignition Coil Assembly No.1
C 8	Ignition Coil Assembly No.5
C 13	Ignition Coil Assembly No.4
C 18	E.F.I. Engine Coolant Temperature Sensor
C 20	Oxygen Sensor (Bank 1 Sensor 2)
C 22	Air Fuel Ratio Sensor (Bank 1 Sensor 1)
C 23	Air Fuel Ratio Sensor (Bank 2 Sensor 1)
C 24	Park/Neutral Position Switch
C 30	Cooler Compressor Assembly
C 34	Electronically Controlled Transmission Solenoid
C 35	Transmission Revolution Sensor (Turbine)
C 36	Transmission Revolution Sensor (Counter Gear)
C 37	Transfer Shift Actuator Assembly
C 38	Transfer Shift Actuator Assembly
C 42	Junction Connector
C 43	Junction Connector
C 44	Junction Connector
C 46	ECM
C 50	Mass Air Flow Meter
C 53	Ignition Coil Assembly No.8
C 55	Purge VSV
C 56	Oxygen Sensor (Bank 2 Sensor 2)
C 59	Power Steering Oil Pressure Sensor
C 60	Air Injection Control Driver
C 61	Air Injection Control Driver
C 96	Electronically Controlled Transmission Solenoid
C 99	Camshaft Position Sensor
C 100	WT Sensor (Bank 1 Intake Side)
C 101	WT Sensor (Bank 2 Intake Side)
C 102	Camshaft Timing Oil Control Valve (Bank 1 Intake Side)
C 103	Camshaft Timing Oil Control Valve (Bank 2 Intake Side)
C 114	Crankshaft Position Sensor
C 121	WT Sensor (Bank 1 Exhaust Side)
C 122	WT Sensor (Bank 2 Exhaust Side)
C 125	Camshaft Timing Oil Control Valve (Bank 1 Exhaust Side)
C 126	Camshaft Timing Oil Control Valve (Bank 2 Exhaust Side)
C 129	VSV (ACIS)
C 130	Ignition Coil Assembly No.3
C 131	Ignition Coil Assembly No.7
C 132	Noise Filter (Ignition Bank 1)
C 133	Ignition Coil Assembly No.6
C 134	Ignition Coil Assembly No.2
C 135	Noise Filter (Ignition Bank 2)

Position of Parts in Engine Compartment <RHD 1UR-FE>

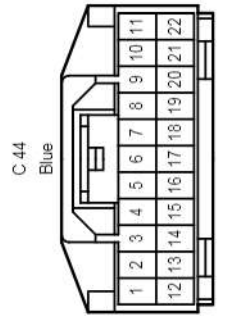
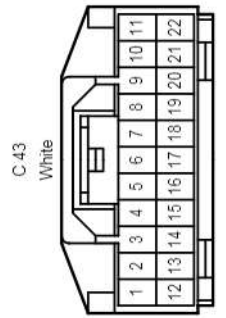
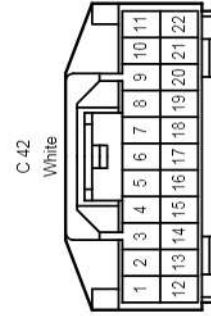
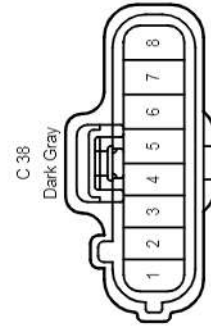
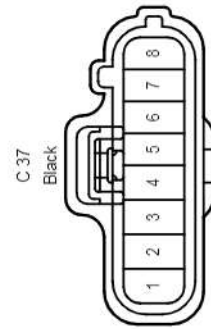
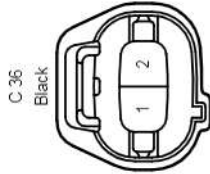
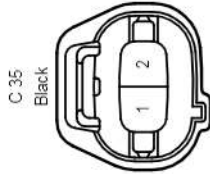
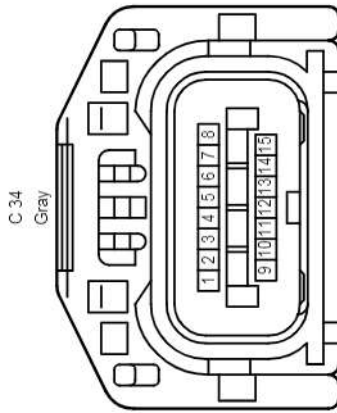
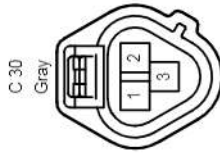
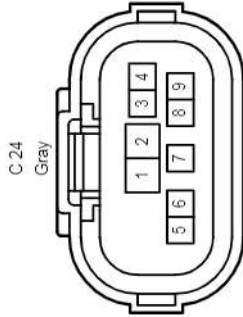
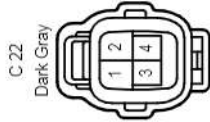
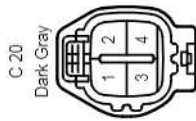
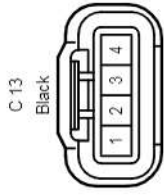
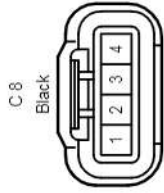
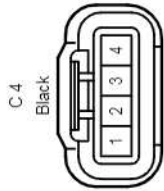
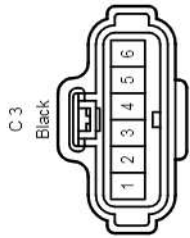

Position of Parts in Engine Compartment <RHD 1UR-FE>

C 46
Black

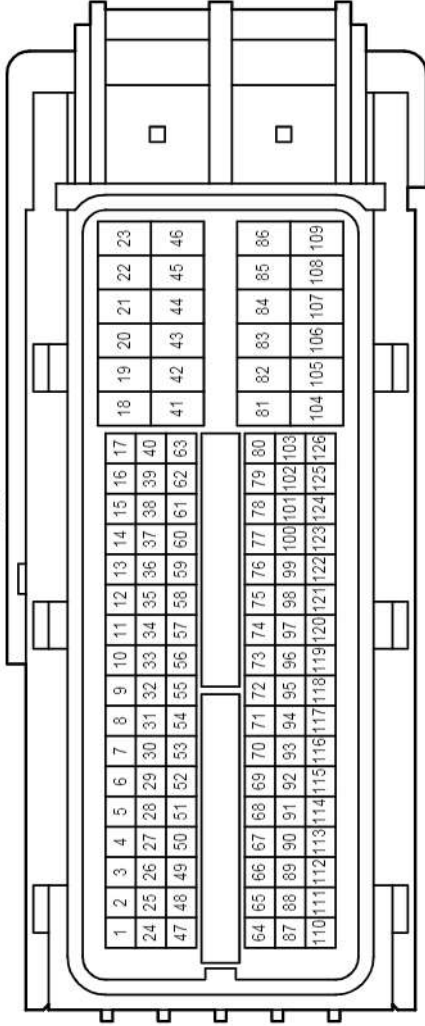

C 50
Black

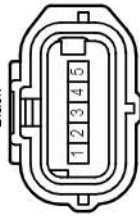

C 53
Black

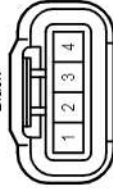

C 55
Black

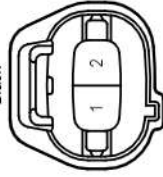

C 56
Dark Gray



C 59
Gray

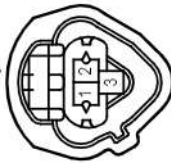

C 60
Black

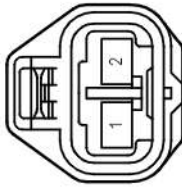

C 61
Black

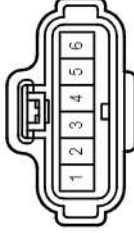

C 96
Gray

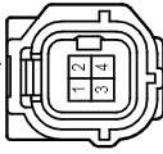

C 99
Black

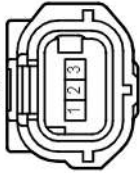

C 100
Black

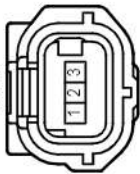

C 101
Black

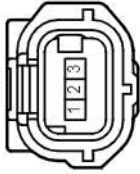

C 102
Black



C 103
Black



C 114
Black



C 121
Black



C 122
Black



C 125
Black



C 126
Black



Position of Parts in Engine Compartment <RHD 1UR-FE>

C133
Gray

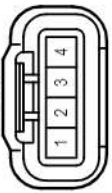

C134
Gray

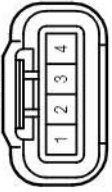

C135
Gray

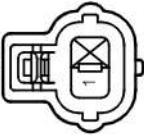

C136
Gray



C137
Black

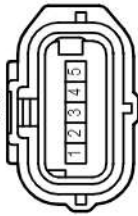

C138
Black

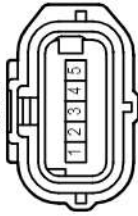

C139
Black

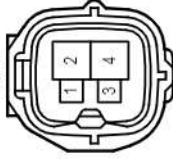

C168
Black

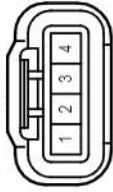

Position of Parts in Engine Compartment <RHD 1UR-FE>

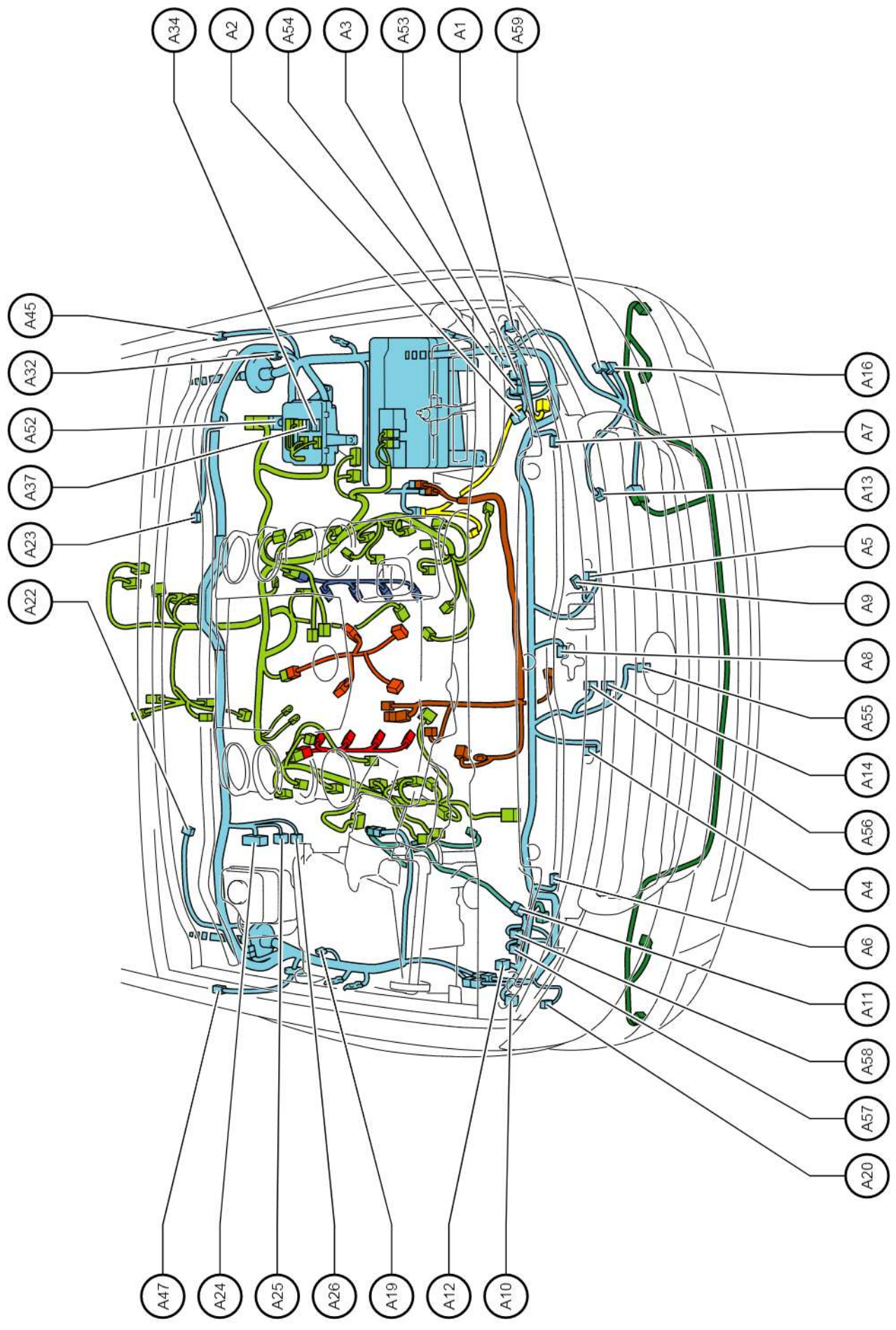

A 1	Headlight Assembly LH
A 2	Headlight Assembly LH
A 3	Headlight Assembly LH
A 4	High Pitched Horn Assembly
A 5	Low Pitched Horn Assembly
A 6	Front Airbag Sensor RH
A 7	Front Airbag Sensor LH
A 8	Engine Hood Courtesy Switch
A 9	Condenser Blower Motor Assembly
A 10	Headlight Assembly RH
A 11	Headlight Assembly RH
A 12	Headlight Assembly RH
A 13	A/C Pressure Sensor
A 14	Ambient Temperature Sensor
A 16	Windshield Washer Motor and Pump Assembly
A 19	Security Horn Assembly
A 20	Wireless Door Lock Buzzer
A 22	Windshield Wiper Motor Assembly
A 23	Front Wiper Deicer (Windshield Glass)
A 24	Skid Control ECU with Actuator Assembly
A 25	Skid Control ECU with Actuator Assembly
A 26	Brake Fluid Level Warning Switch (Brake Master Cylinder Reservoir Assembly)
A 32	Noise Filter
A 34	Junction Connector
A 37	Junction Connector
A 45	Side Turn Signal Light Assembly LH
A 47	Side Turn Signal Light Assembly RH
A 52	ECM
A 53	Headlight Assembly LH
A 54	Headlight Assembly LH
A 55	Front Television Camera Assembly
A 56	Millimeter Wave Radar Sensor Assembly
A 57	Headlight Assembly RH
A 58	Headlight Assembly RH
A 59	Headlight Cleaner Control Relay and Motor

Position of Parts in Engine Compartment <RHD 1UR-FE>

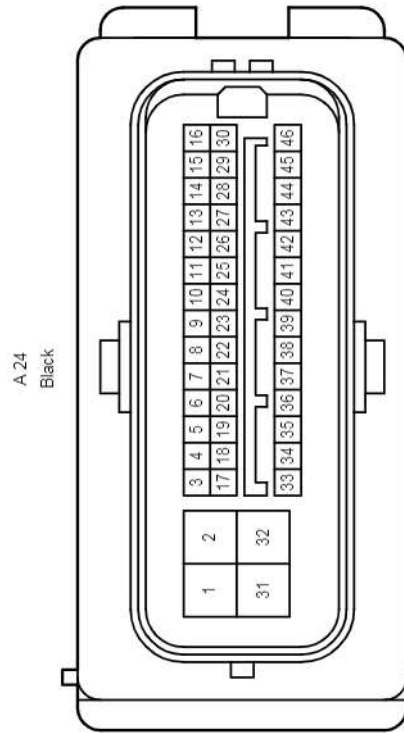
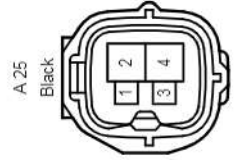
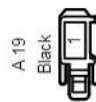
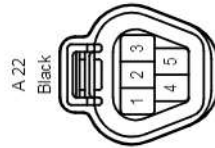
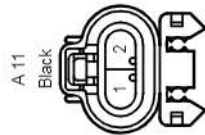
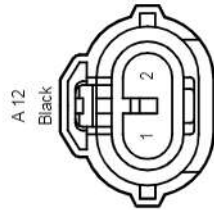
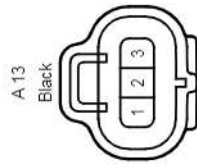
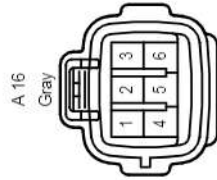
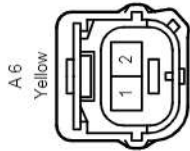
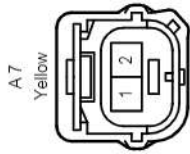
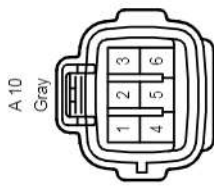
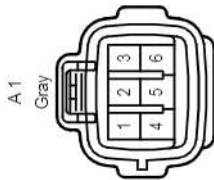
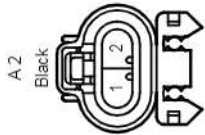
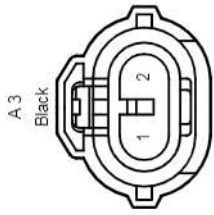

Position of Parts in Engine Compartment <RHD 1UR-FE>

A 37
Blue

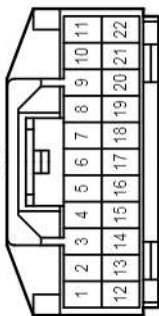

A 45
Gray



A 47
Gray



A 52
Black

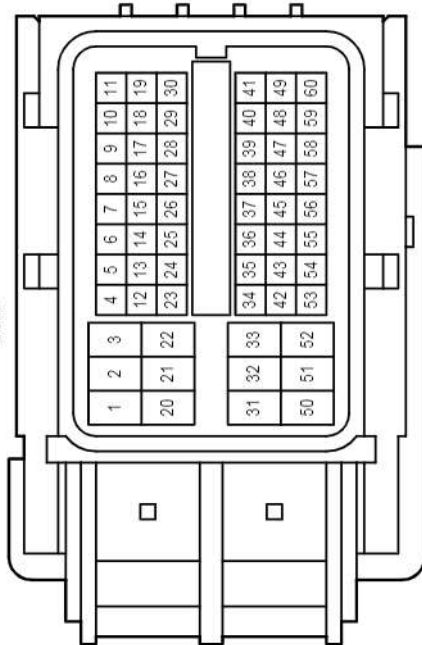

A 53
Black



A 54
Black

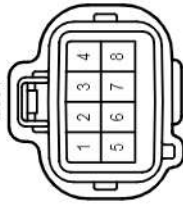

A 55
Black

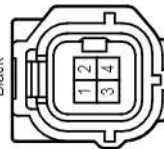

A 56
Black

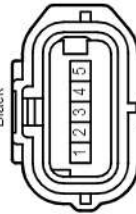

A 57
Black



A 58
Black

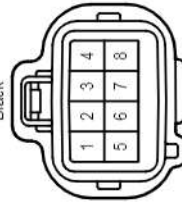

A 59
White



Position of Parts in Engine Compartment <RHD 1UR-FE>

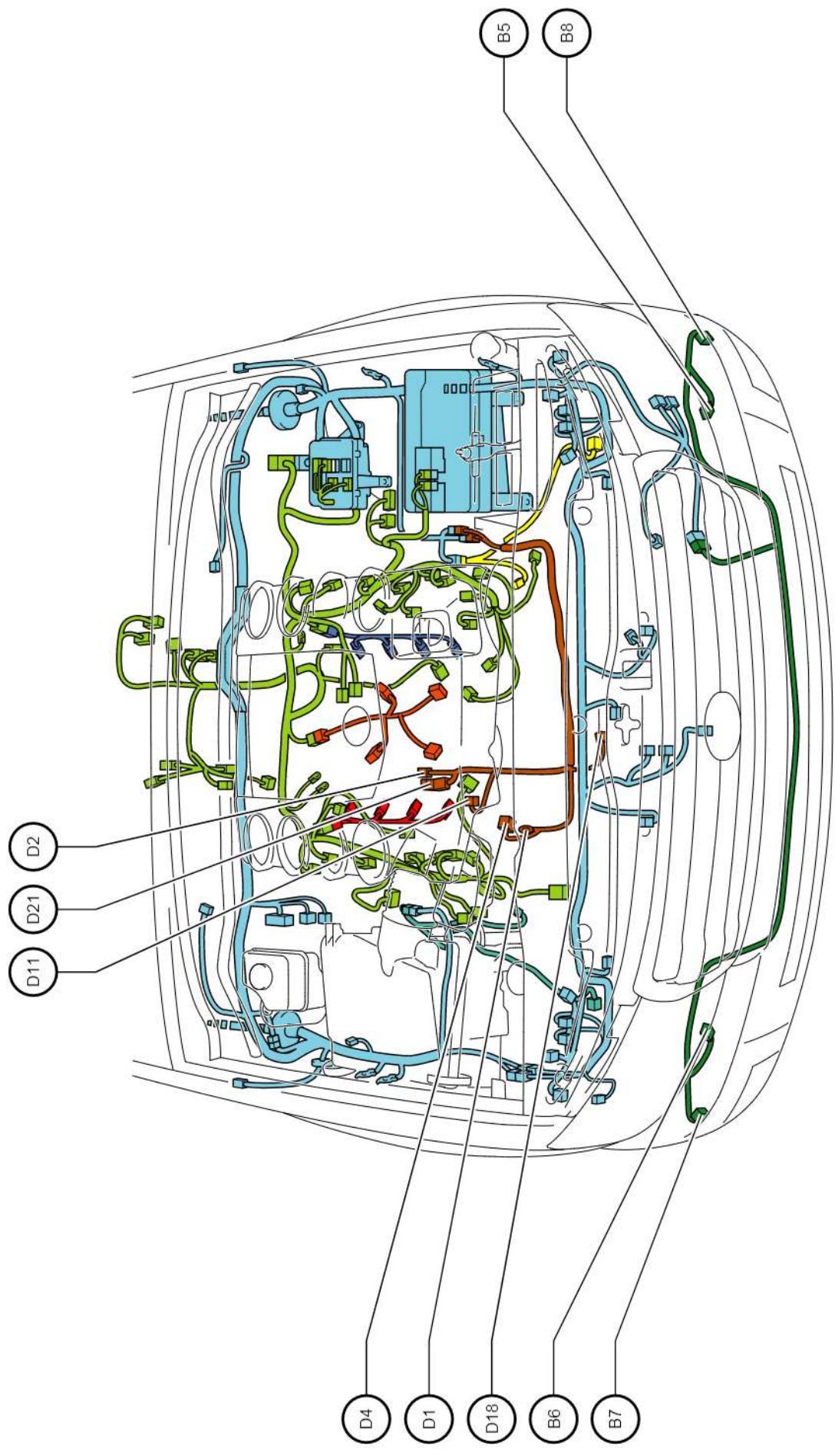

Position of Parts in Engine Compartment <RHD 1UR-FE>

- B 5 Fog Light Assembly LH
- B 6 Fog Light Assembly RH
- B 7 No.1 Ultrasonic Sensor RH
- B 8 No.1 Ultrasonic Sensor LH

- D 1 Generator Assembly
- D 2 Starter Assembly
- D 4 Generator Assembly
- D 11 Engine Oil Level Sensor
- D 18 Oil Pressure Sender Gage Assembly
- D 21 Starter Assembly

Position of Parts in Engine Compartment <RHD 1UR-FE>

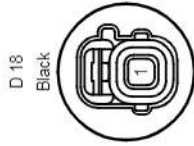
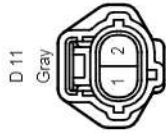
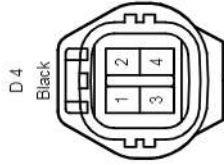
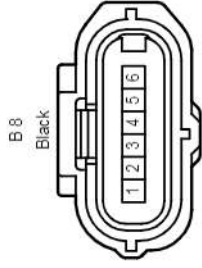
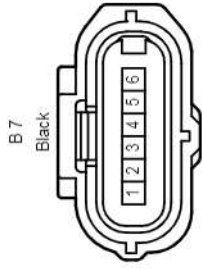
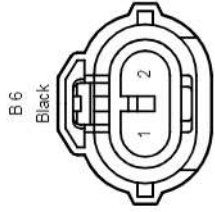
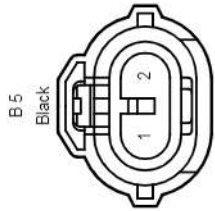

Position of Parts in Engine Compartment <RHD 1UR-FE>

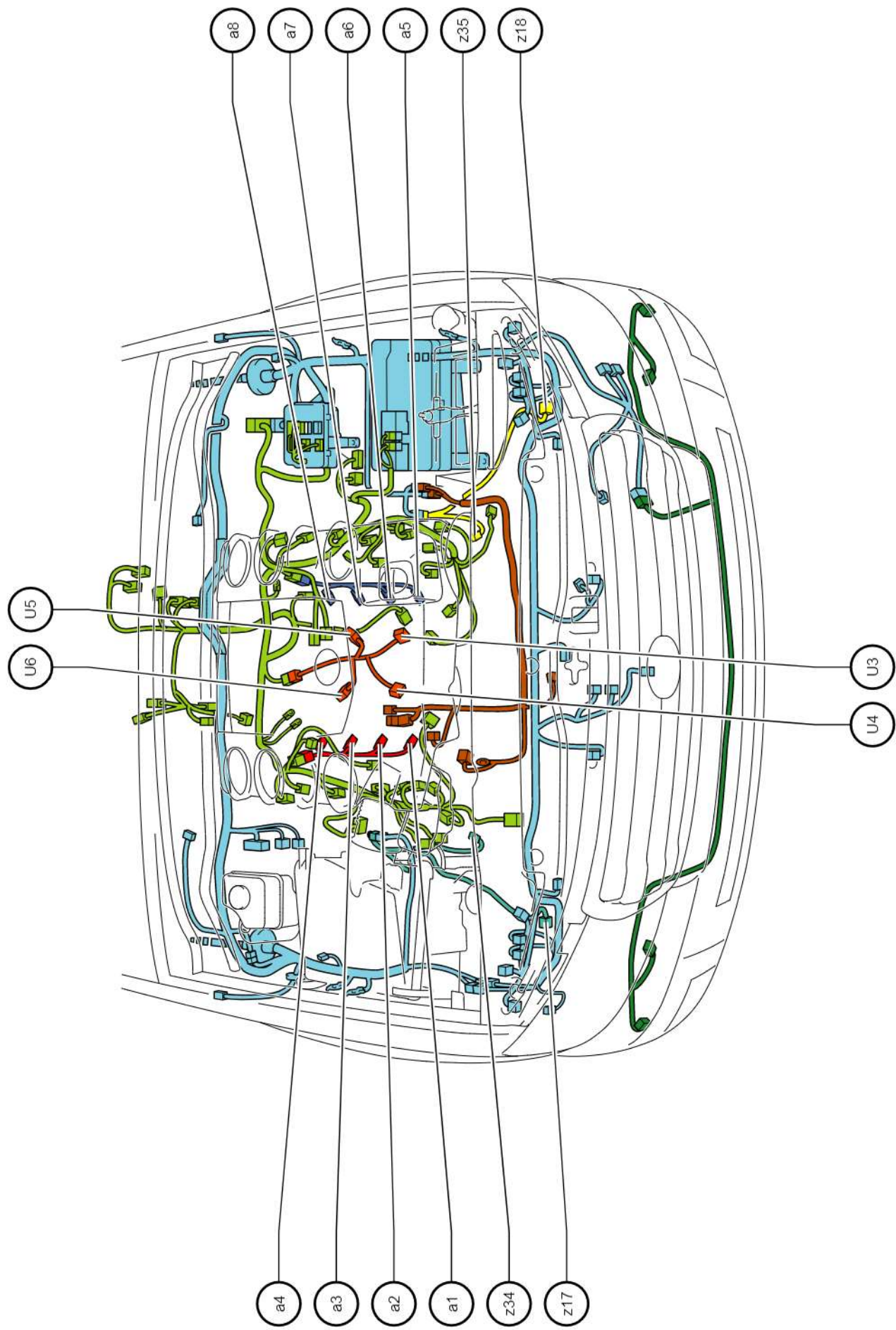

- U 3 Knock Control Sensor (Bank 1 Sensor 1)
- U 4 Knock Control Sensor (Bank 2 Sensor 1)
- U 5 Knock Control Sensor (Bank 1 Sensor 2)
- U 6 Knock Control Sensor (Bank 2 Sensor 2)

- a 1 Fuel Injector Assembly No.2
- a 2 Fuel Injector Assembly No.4
- a 3 Fuel Injector Assembly No.6
- a 4 Fuel Injector Assembly No.8
- a 5 Fuel Injector Assembly No.1
- a 6 Fuel Injector Assembly No.3
- a 7 Fuel Injector Assembly No.5
- a 8 Fuel Injector Assembly No.7

- z 17 Front Speed Sensor RH
- z 18 Front Speed Sensor LH
- z 34 Front Height Control Sensor Sub-Assembly RH
- z 35 Front Height Control Sensor Sub-Assembly LH

Position of Parts in Engine Compartment <RHD 1UR-FE>

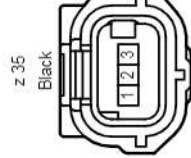
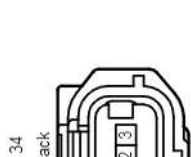
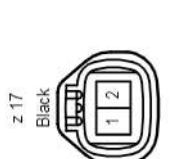
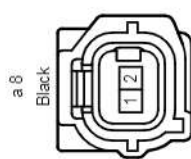
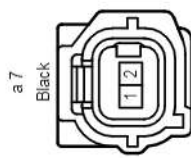
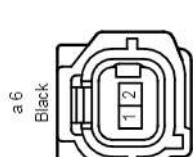
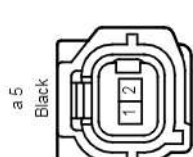
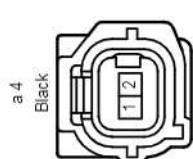
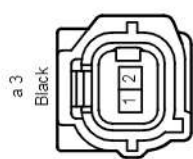
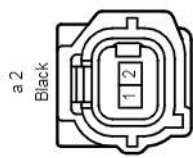
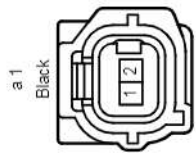
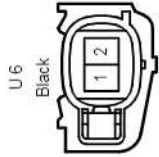
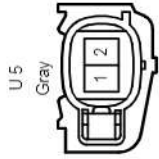
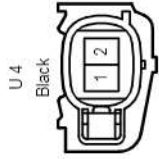
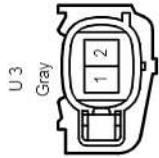

Wire and Wire in Engine Compartment <RHD 1UR-FE>

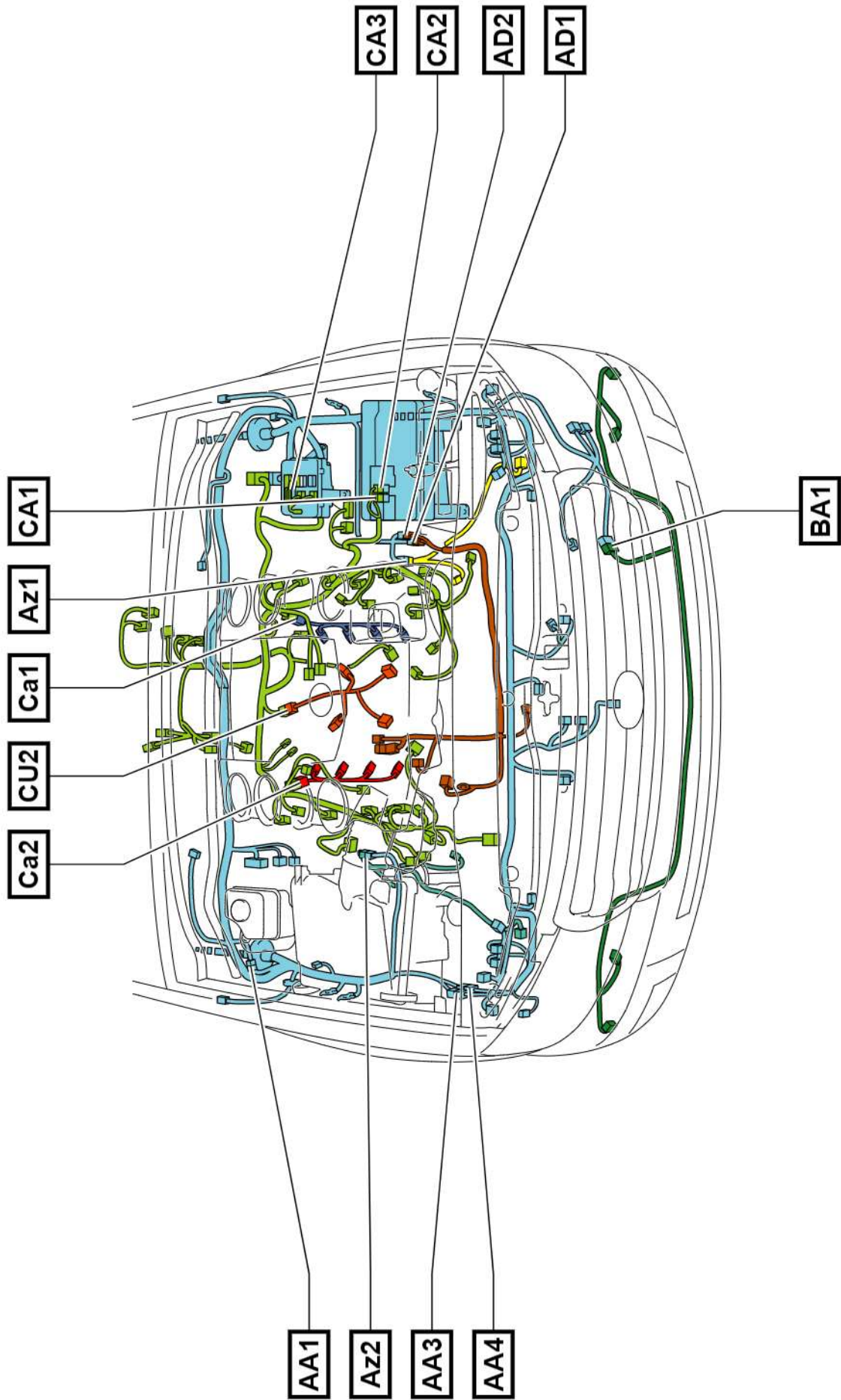

Wire and Wire in Engine Compartment <RHD 1UR-FE>

AA3
Gray

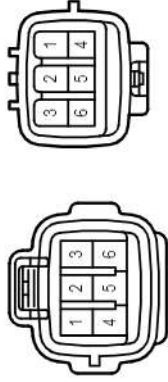

AA1
Gray

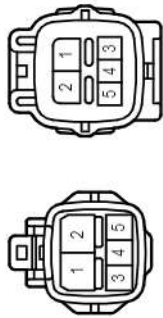

AD1
Black

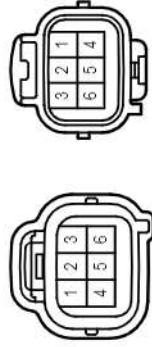

AA4
Yellow

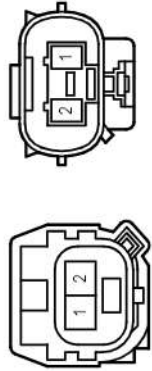

Az1
Gray

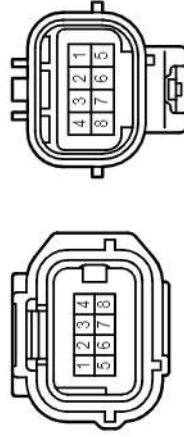

AD2
Black

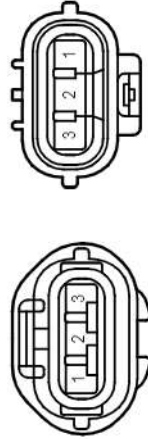

BA1
Black

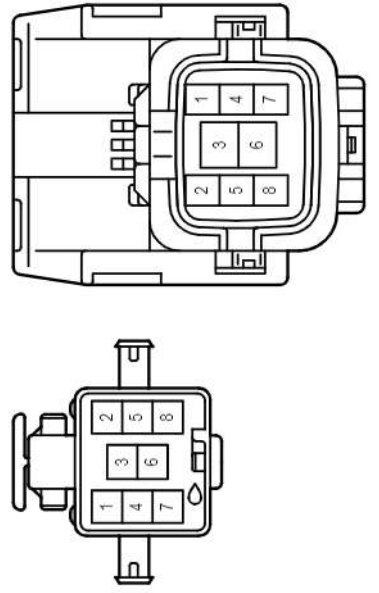

Az2
Gray

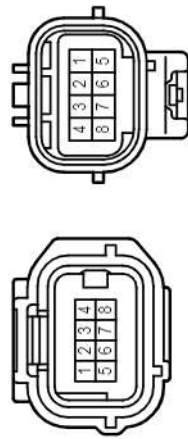

cardiagn.com

Wire and Wire in Engine Compartment <RHD 1UR-FE>

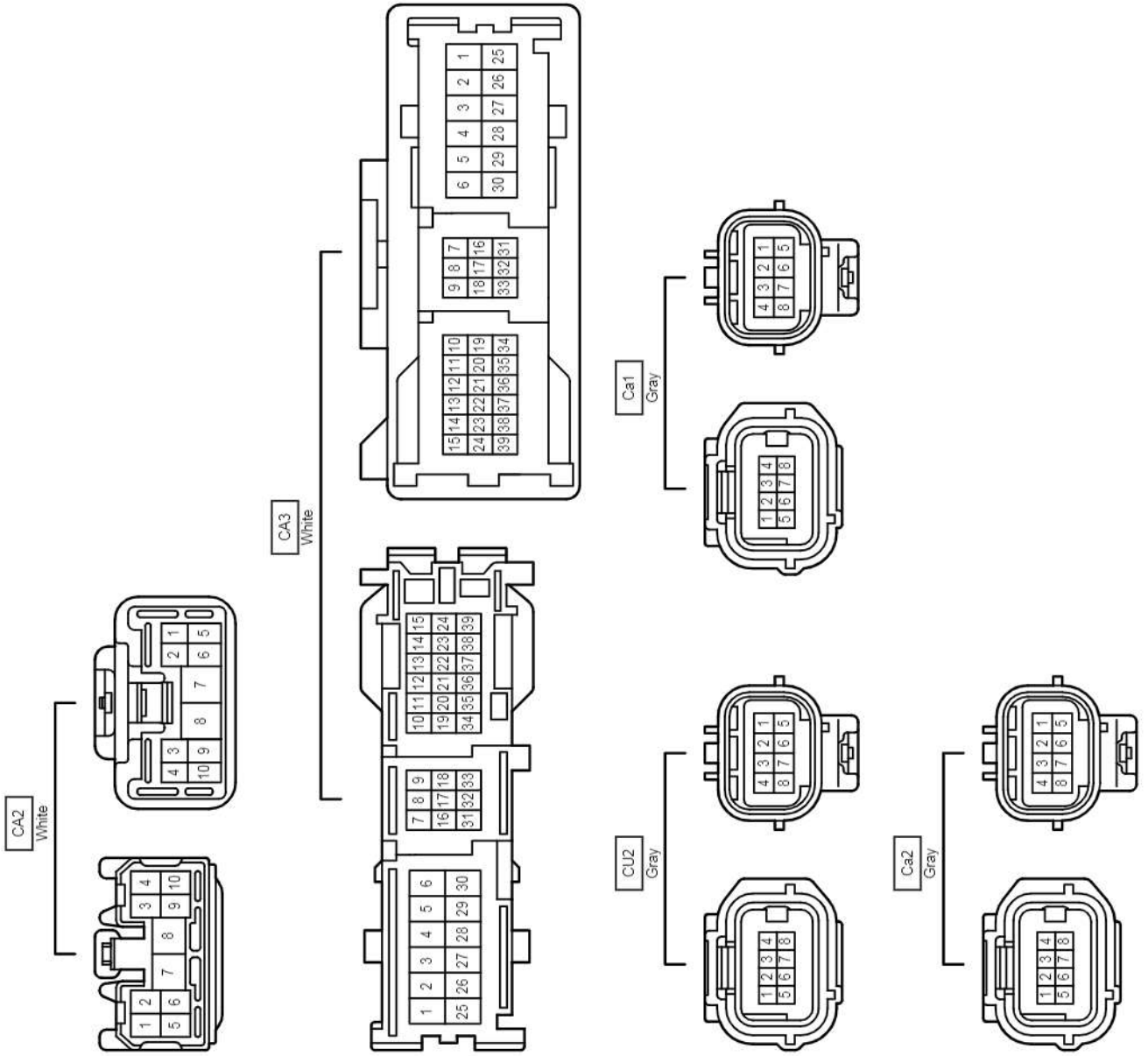

Ground Points in Engine Compartment <LHD 1VD-FTV>

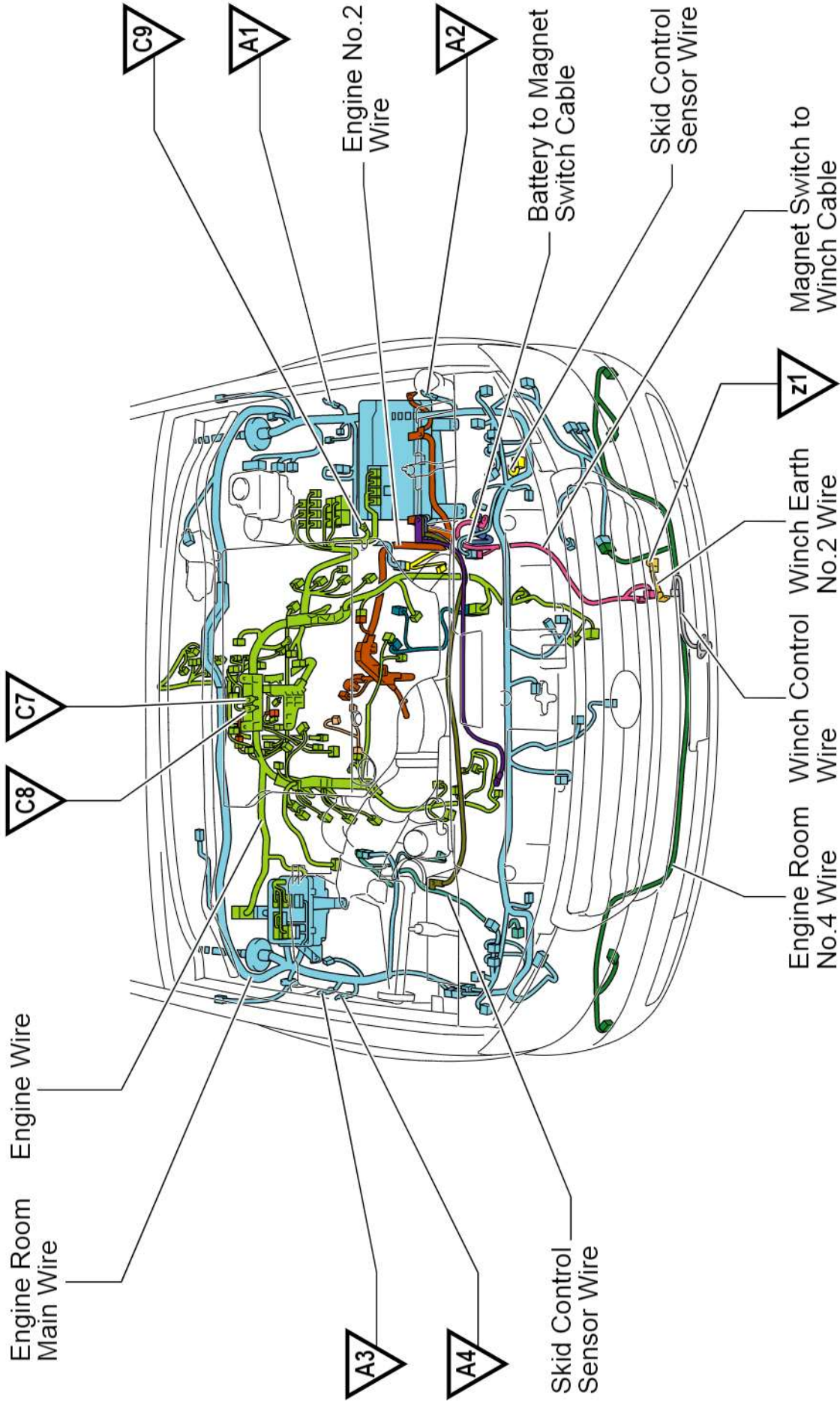

Position of Parts in Engine Compartment <LHD 1VD-FTV>

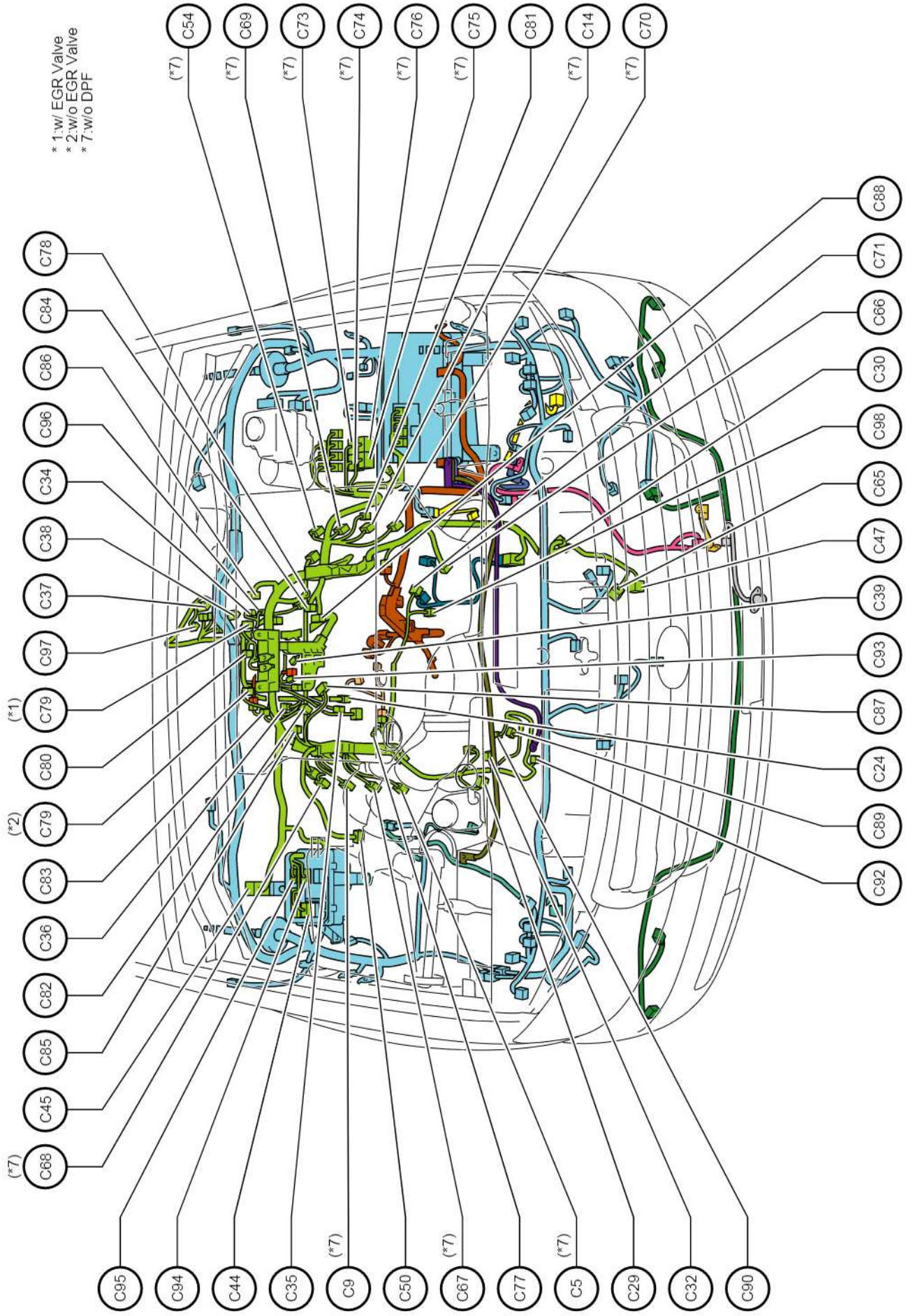

C 5	Fuel Injector Assembly No.1
C 9	Fuel Injector Assembly No.5
C 14	Fuel Injector Assembly No.4
C 24	Park/Neutral Position Switch
C 29	Power Steering Oil Pressure Switch
C 30	Cooler Compressor Assembly
C 32	Engine Oil Level Sensor
C 34	Electronically Controlled Transmission Solenoid
C 35	Transmission Revolution Sensor (Turbine)
C 36	Transmission Revolution Sensor (Counter Gear)
C 37	Transfer Shift Actuator Assembly
C 38	Transfer Shift Actuator Assembly
C 39	Back-Up Light Switch Assembly
C 44	Junction Connector
C 45	ECM
C 47	Oil Pressure Sender Gage Assembly
C 50	Mass Air Flow Meter
C 54	Fuel Injector Assembly No.8
C 65	Crankshaft Position Sensor
C 66	Camshaft Position Sensor
C 67	Fuel Injector Assembly No.3
C 68	Fuel Injector Assembly No.7
C 69	Fuel Injector Assembly No.6
C 70	Fuel Injector Assembly No.2
C 71	E.F.I. Engine Coolant Temperature Sensor
C 73	Injector Driver (No.1)
C 74	Injector Driver (No.1)
C 75	Injector Driver (No.2)
C 76	Injector Driver (No.2)
C 77	Glow Plug Assembly
C 78	Glow Plug Assembly
C 79	Intake Air Temperature Sensor
C 80	Diesel Turbo Pressure Sensor
C 81	VSV (ACM)
C 82	Fuel Pressure Sensor
C 83	Diesel Throttle Body Assembly RH
C 84	Diesel Throttle Body Assembly LH
C 85	Diesel Throttle Body Assembly RH
C 86	Diesel Throttle Body Assembly LH
C 87	No.1 EGR Valve Assembly
C 88	No.2 EGR Valve Assembly
C 89	DC Motor and Nozzle Vane Position Sensor RH
C 90	DC Motor and Nozzle Vane Position Sensor RH
C 92	Generator Assembly

Position of Parts in Engine Compartment <LHD 1VD-F-TV>

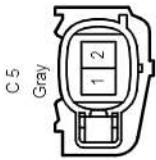

C.5
Gray



C.9
Gray



C.14
Gray

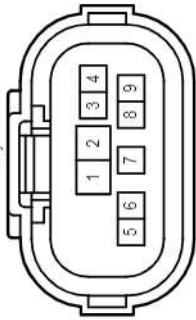

C.24
Gray



C.29
Black

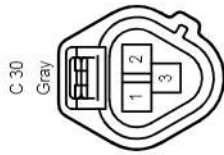

C.30
Gray



C.32
Gray

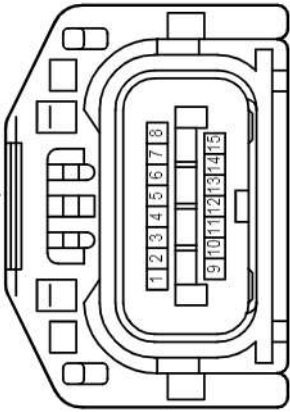

C.34
Gray

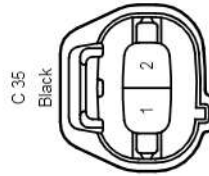

C.35
Black

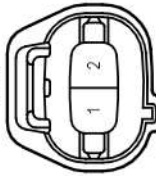

C.36
Black

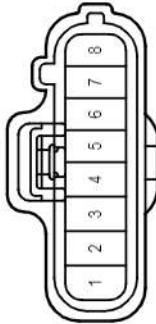

C.37
Black

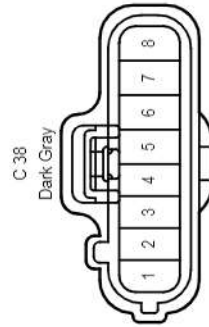

C.38
Dark Gray

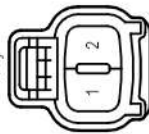

C.39
Gray

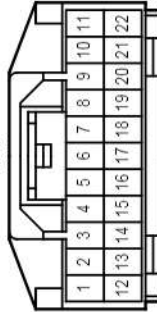

C.44
Blue

C.45
Black

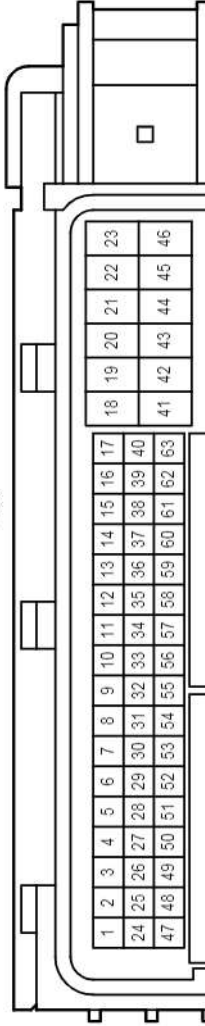

Position of Parts in Engine Compartment <LHD 1VD-F-TV>

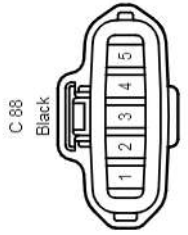
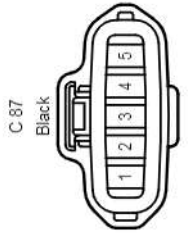
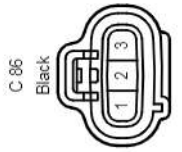
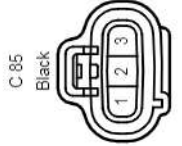
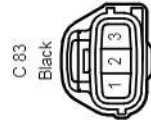
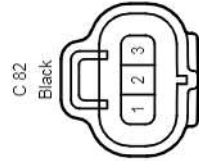
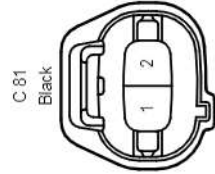
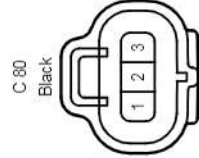
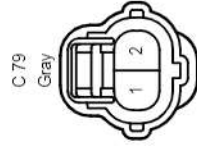
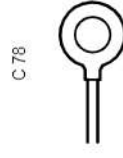
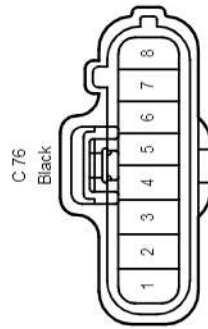
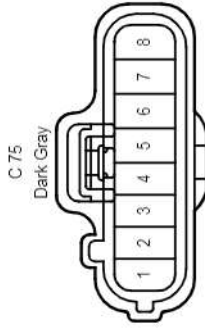
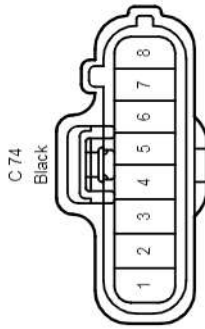
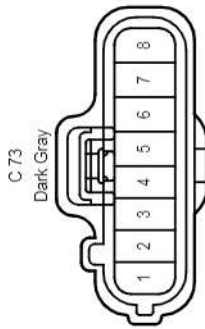
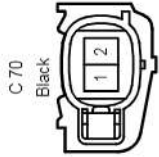
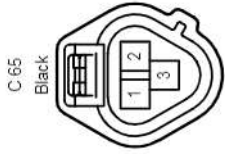
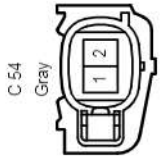
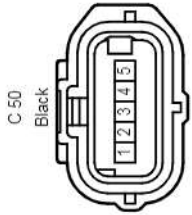
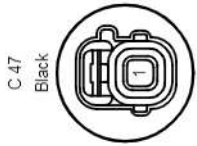

Position of Parts in Engine Compartment <LHD 1VD-F-TV>

C 94
Gray

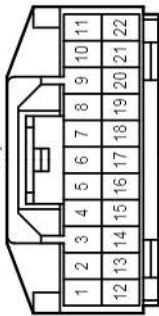

C 95
Black

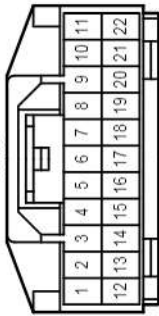

C 96
Gray

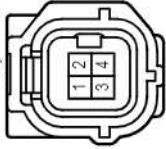

C 97
Black



C 98
Gray



Position of Parts in Engine Compartment <LHD 1VD-FTV>

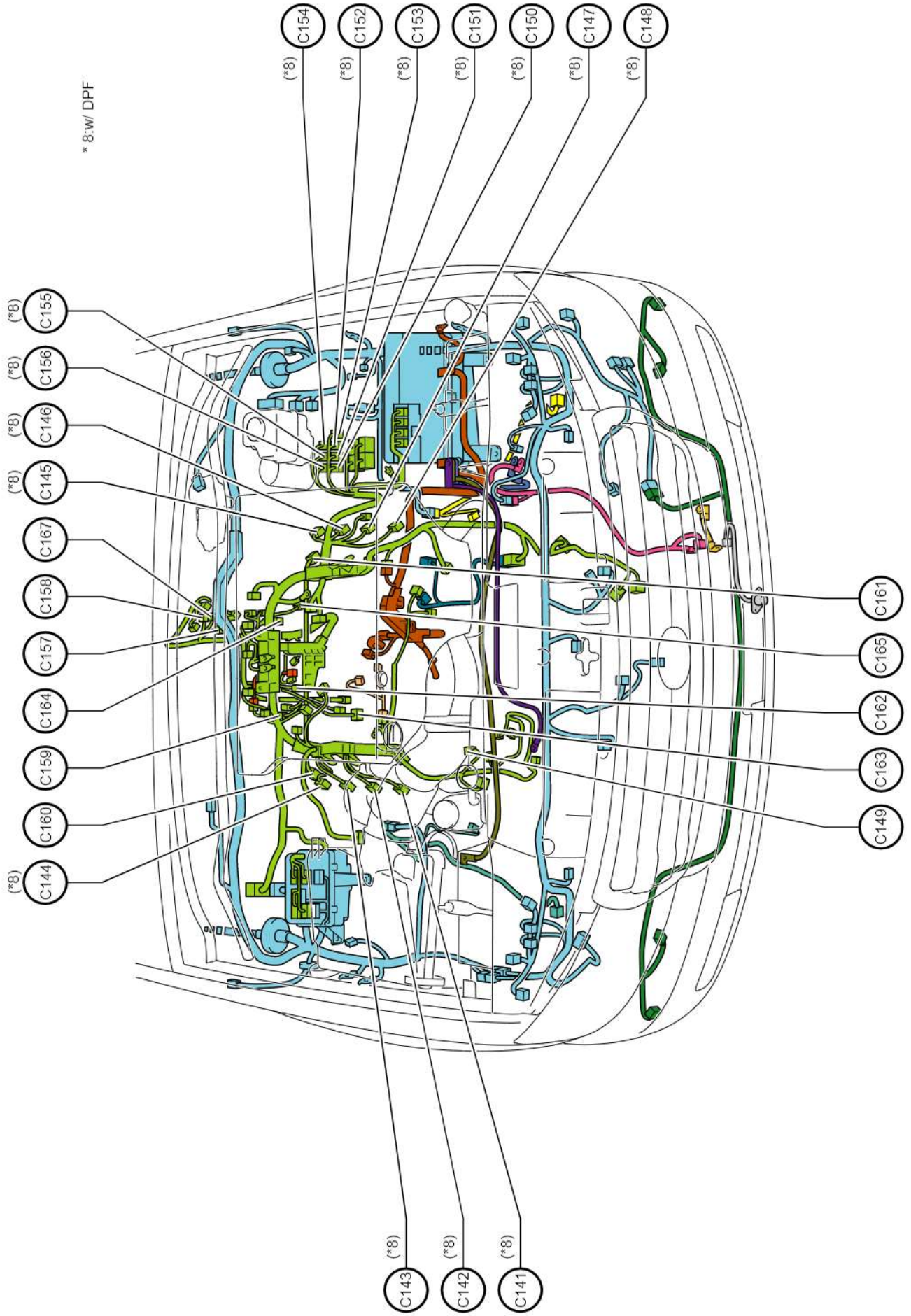

- C 141 Fuel Injector Assembly No.1
- C 142 Fuel Injector Assembly No.3
- C 143 Fuel Injector Assembly No.5
- C 144 Fuel Injector Assembly No.7
- C 145 Fuel Injector Assembly No.8
- C 146 Fuel Injector Assembly No.6
- C 147 Fuel Injector Assembly No.4
- C 148 Fuel Injector Assembly No.2
- C 149 Vane Pump Assembly
- C 150 Injector Driver (No.1)
- C 151 Injector Driver (No.1)
- C 152 Injector Driver (No.1)
- C 153 Injector Driver (No.1)
- C 154 Injector Driver (No.2)
- C 155 Injector Driver (No.2)
- C 156 Injector Driver (No.2)
- C 157 Differential Pressure Sensor LH
- C 158 Air Fuel Ratio Sensor (Bank 2 Sensor 1)
- C 159 Air Fuel Ratio Sensor (Bank 1 Sensor 1)
- C 160 Exhaust Fuel Addition Injector Assembly RH
- C 161 Exhaust Fuel Addition Injector Assembly LH
- C 162 Exhaust Gas Temperature Sensor
- C 163 No.2 Exhaust Gas Temperature Sensor
- C 164 No.3 Exhaust Gas Temperature Sensor
- C 165 No.4 Exhaust Gas Temperature Sensor
- C 167 DPF Temperature Sensor LH (Exhaust Gas Temperature Sensor)

Position of Parts in Engine Compartment <LHD 1VD-F-TV>

C141
Gray

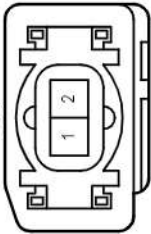

C142
Black

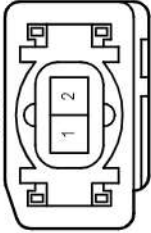

C143
Gray

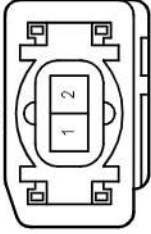

C144
Black

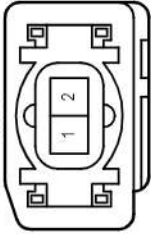

C145
Gray

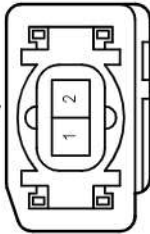

C146
Black

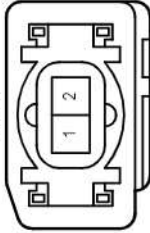

C147
Gray

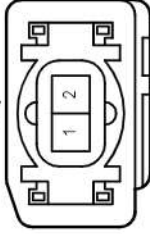

C148
Black

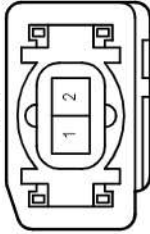

C149
Black



C150
Black

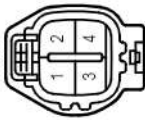

C151
Black

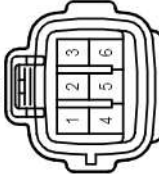

C152
Black

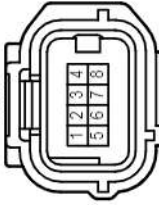

C153
Black



C154
Black

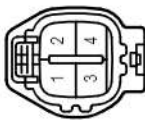

C155
Black

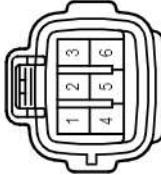

C156
Black

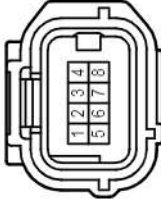

C157
Black



C158
Dark Gray

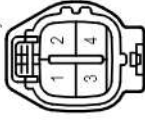

C159
Dark Gray



C160
Black



C161
Black



C162
Gray



C163
Gray



C164
Gray



C165
Gray



C167
Gray



Position of Parts in Engine Compartment <LHD 1VD-FTV>

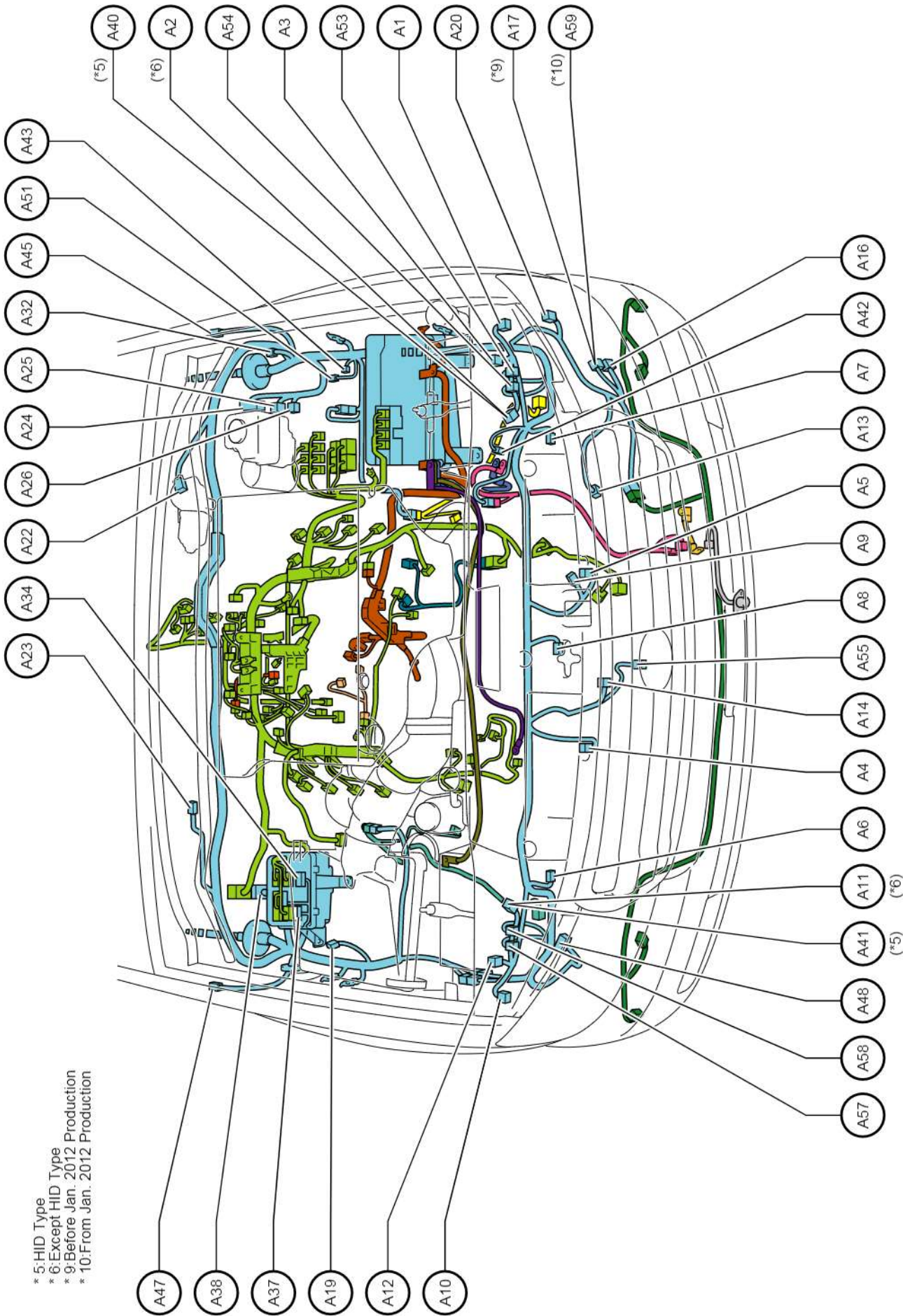

* 5: HID Type
 * 6: Except HID Type
 * 9: Before Jan. 2012 Production
 * 10: From Jan. 2012 Production

A 1	Headlight Assembly LH
A 2	Headlight Assembly LH
A 3	Headlight Assembly LH
A 4	High Pitched Horn Assembly
A 5	Low Pitched Horn Assembly
A 6	Front Airbag Sensor RH
A 7	Front Airbag Sensor LH
A 8	Engine Hood Courtesy Switch
A 8	Engine Hood Courtesy Switch
A 9	Condenser Blower Motor Assembly
A 10	Headlight Assembly RH
A 11	Headlight Assembly RH
A 12	Headlight Assembly RH
A 13	A/C Pressure Sensor
A 14	Ambient Temperature Sensor
A 16	Windshield Washer Motor and Pump Assembly
A 17	Headlight Cleaner Control Relay and Motor
A 19	Security Horn Assembly
A 20	Wireless Door Lock Buzzer
A 22	Windshield Wiper Motor Assembly
A 23	Front Wiper Deicer (Windshield Glass)
A 24	Skid Control ECU with Actuator Assembly
A 25	Skid Control ECU with Actuator Assembly
A 26	Brake Fluid Level Warning Switch (Brake Master Cylinder Reservoir Assembly)
A 32	Noise Filter
A 34	Junction Connector
A 37	Junction Connector
A 38	ECM
A 40	Headlight Assembly LH
A 41	Headlight Assembly RH
A 42	Winch Main Relay (No.1 Magnet Switch Assembly)
A 43	Level Warning Switch (Fuel Filter Assembly)
A 45	Side Turn Signal Light Assembly LH
A 47	Side Turn Signal Light Assembly RH
A 48	Turbo Motor Driver
A 51	Clogging Switch (Fuel Filter Assembly)
A 53	Headlight Assembly LH
A 54	Headlight Assembly LH
A 55	Front Television Camera Assembly
A 57	Headlight Assembly RH
A 58	Headlight Assembly RH
A 59	Headlight Cleaner Control Relay and Motor

Position of Parts in Engine Compartment <LHD 1VD-F-TV>

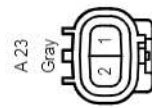
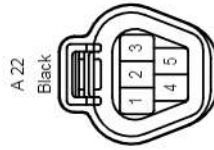
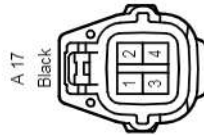
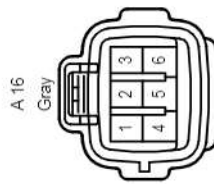
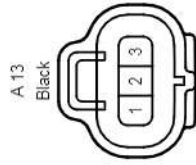
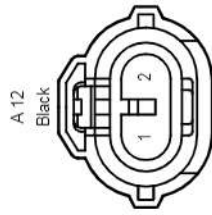
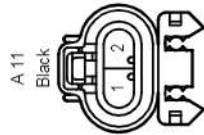
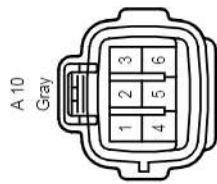
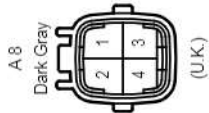
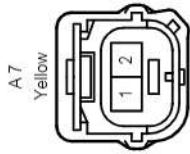
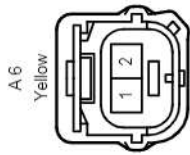
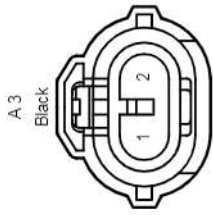
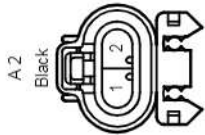
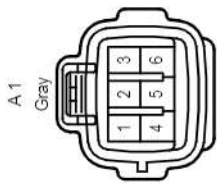

A 24
Black

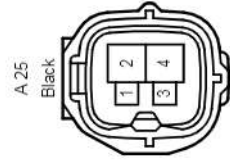
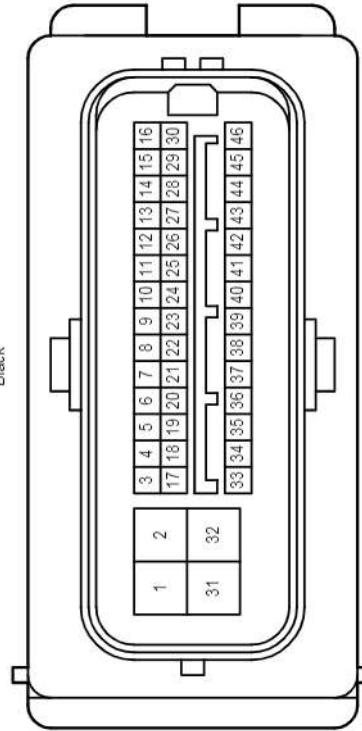

Position of Parts in Engine Compartment <LHD 1VD-F-TV>

A 37
Blue

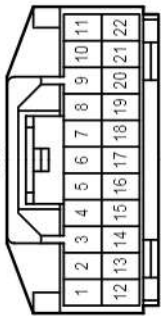

A 38
Black

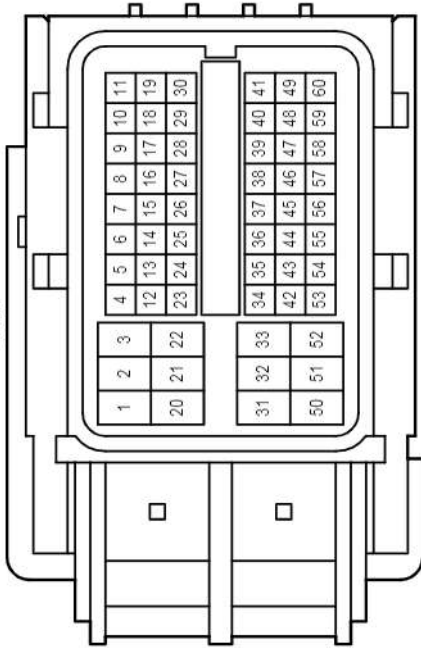

A 40
Gray



A 41
Gray



A 42
Black



A 43
Gray



A 45
Gray



A 47
Gray



A 48
Black

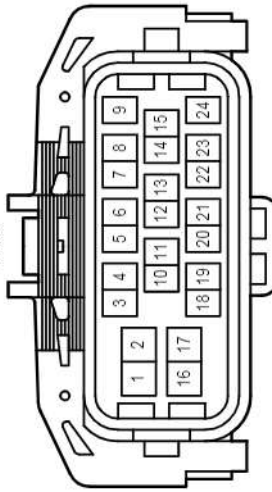

A 51
Black

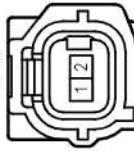

A 53
Black



A 54
Black

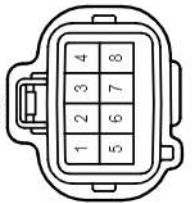

A 55
Black

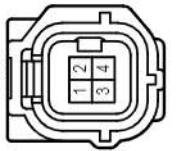

A 57
Black



A 58
Black

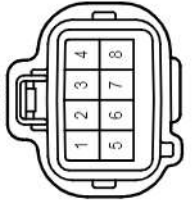

A 59
White



Position of Parts in Engine Compartment <LHD 1VD-FTV>

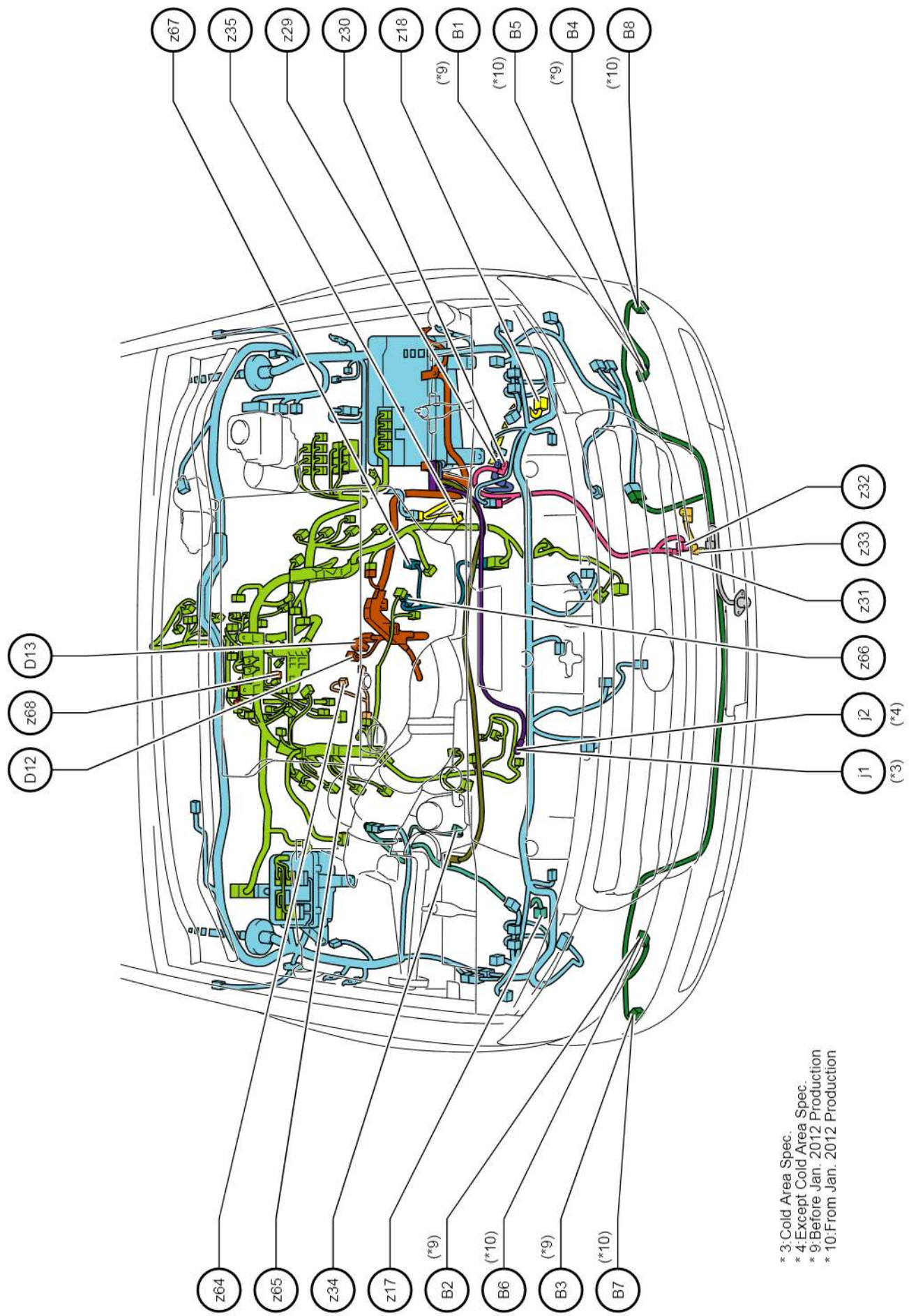

* 3: Cold Area Spec.
 * 4: Except Cold Area Spec.
 * 9: Before Jan. 2012 Production
 * 10: From Jan. 2012 Production

B	1	Fog Light Assembly LH
B	2	Fog Light Assembly RH
B	3	No.1 Ultrasonic Sensor RH
B	4	No.1 Ultrasonic Sensor LH
B	5	Fog Light Assembly LH
B	6	Fog Light Assembly RH
B	7	No.1 Ultrasonic Sensor RH
B	8	No.1 Ultrasonic Sensor LH
D	12	Starter Assembly
D	13	Starter Assembly
j	1	Generator Assembly
j	2	Generator Assembly
z	17	Front Speed Sensor RH
z	18	Front Speed Sensor LH
z	29	Winch Main Relay (No.1 Magnet Switch Assembly)
z	30	Winch Main Relay (No.1 Magnet Switch Assembly)
z	31	With Magnet Switch Winch Motor Assembly
z	32	With Magnet Switch Winch Motor Assembly
z	33	With Magnet Switch Winch Motor Assembly
z	34	Front Height Control Sensor Sub-Assembly RH
z	35	Front Height Control Sensor Sub-Assembly LH
z	64	Suction Control Valve (Injection or Supply Pump Assembly)
z	65	Fuel Temperature Sensor (Injection or Supply Pump Assembly)
z	66	DC Motor and Nozzle Vane Position Sensor LH
z	67	DC Motor and Nozzle Vane Position Sensor LH
z	68	Pressure Discharge Valve

Position of Parts in Engine Compartment <LHD 1VD-F-TV>

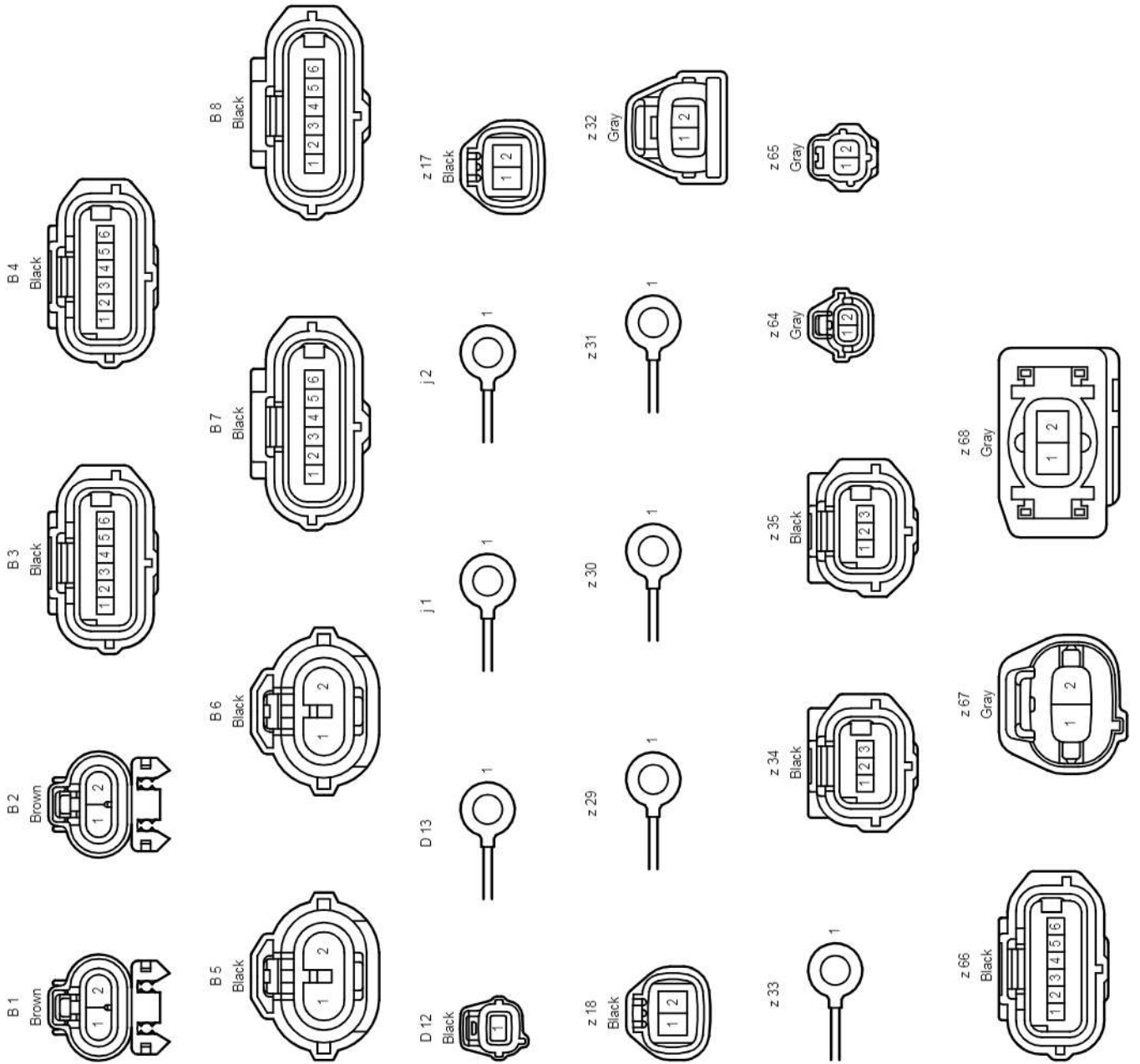

Wire and Wire in Engine Compartment <LHD 1VD-FTV>

- * 1:Liftgate Type Body
- * 2:Swing Type Body



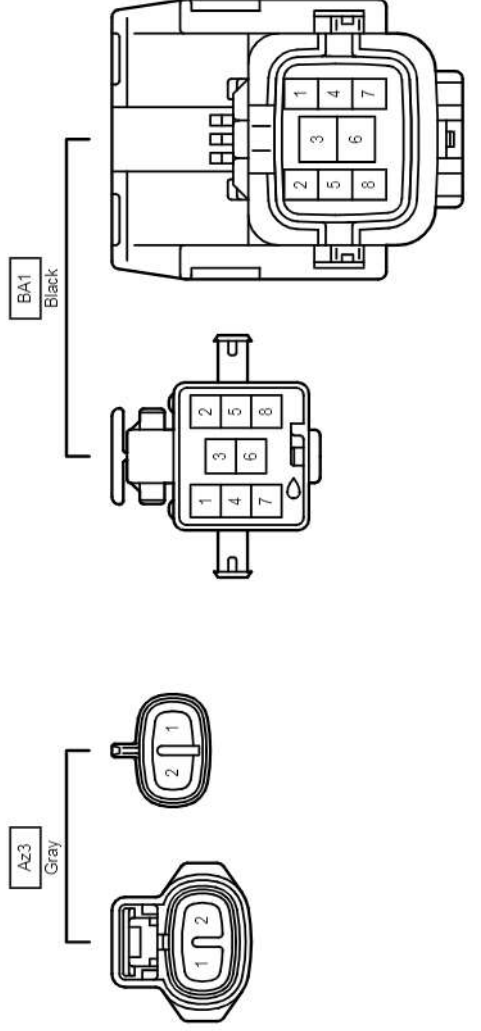
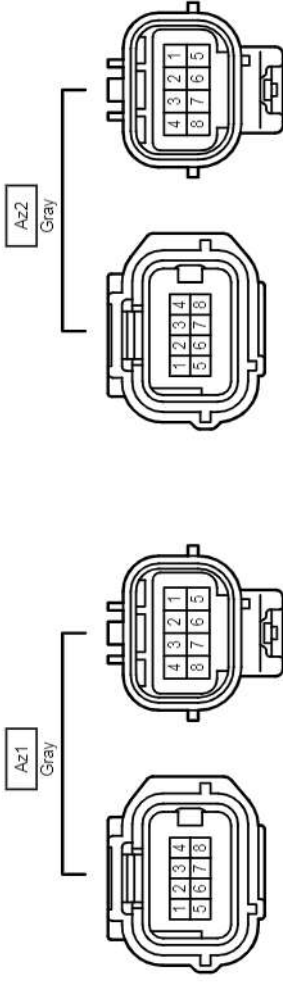
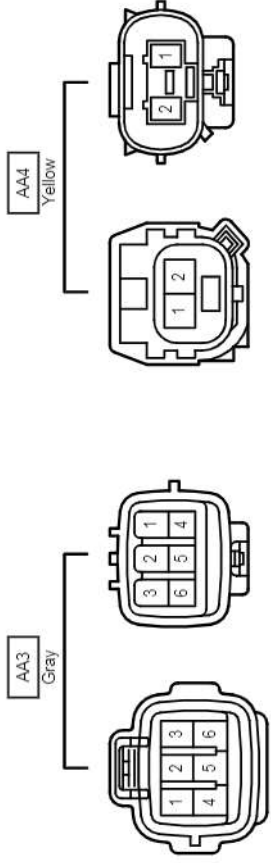
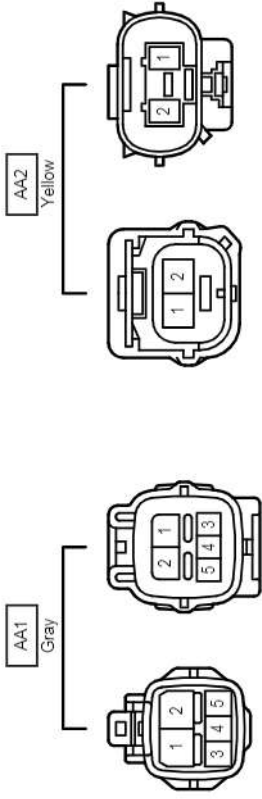

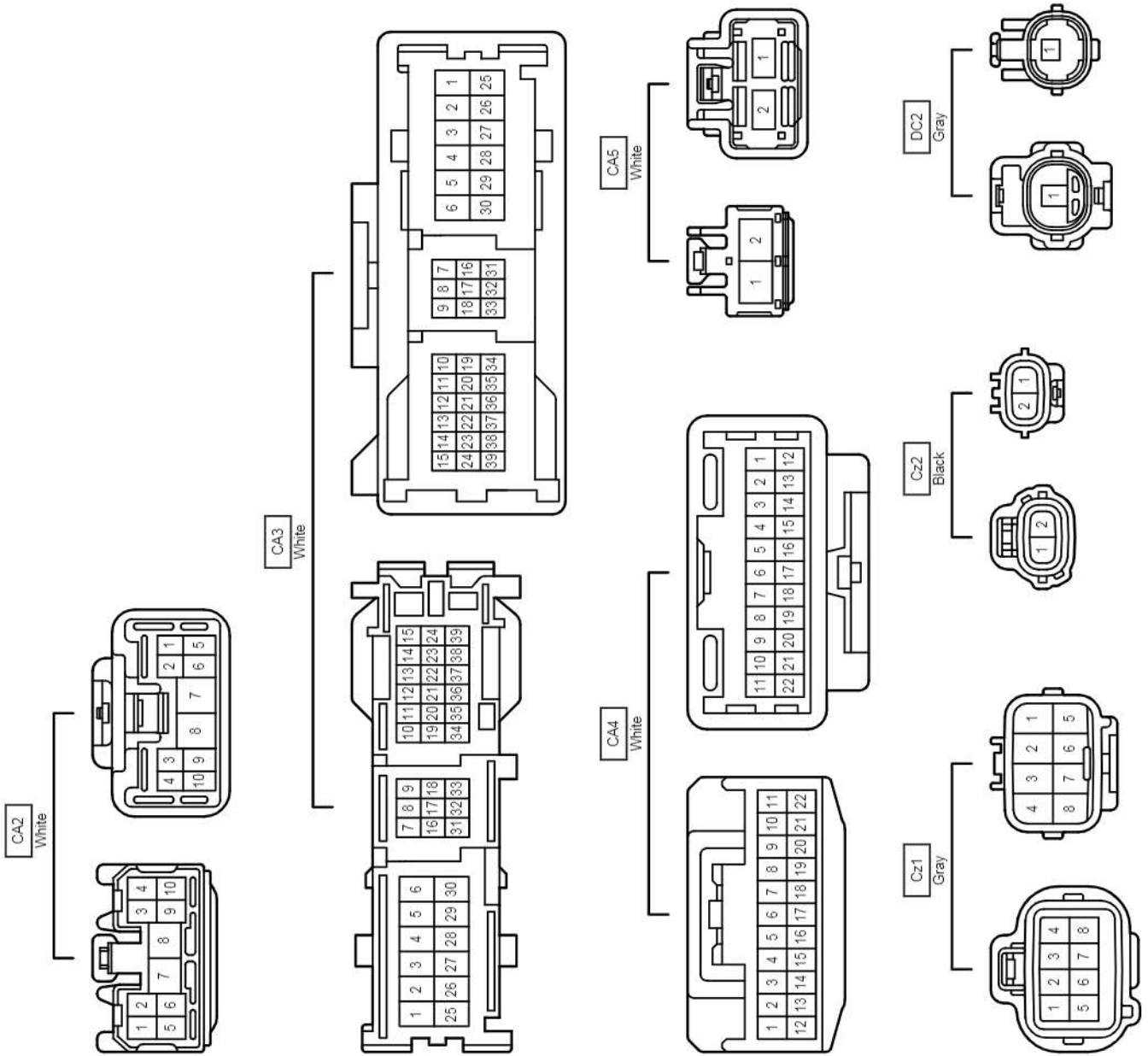

Ground Points in Engine Compartment <RHD 1VD-FTV>

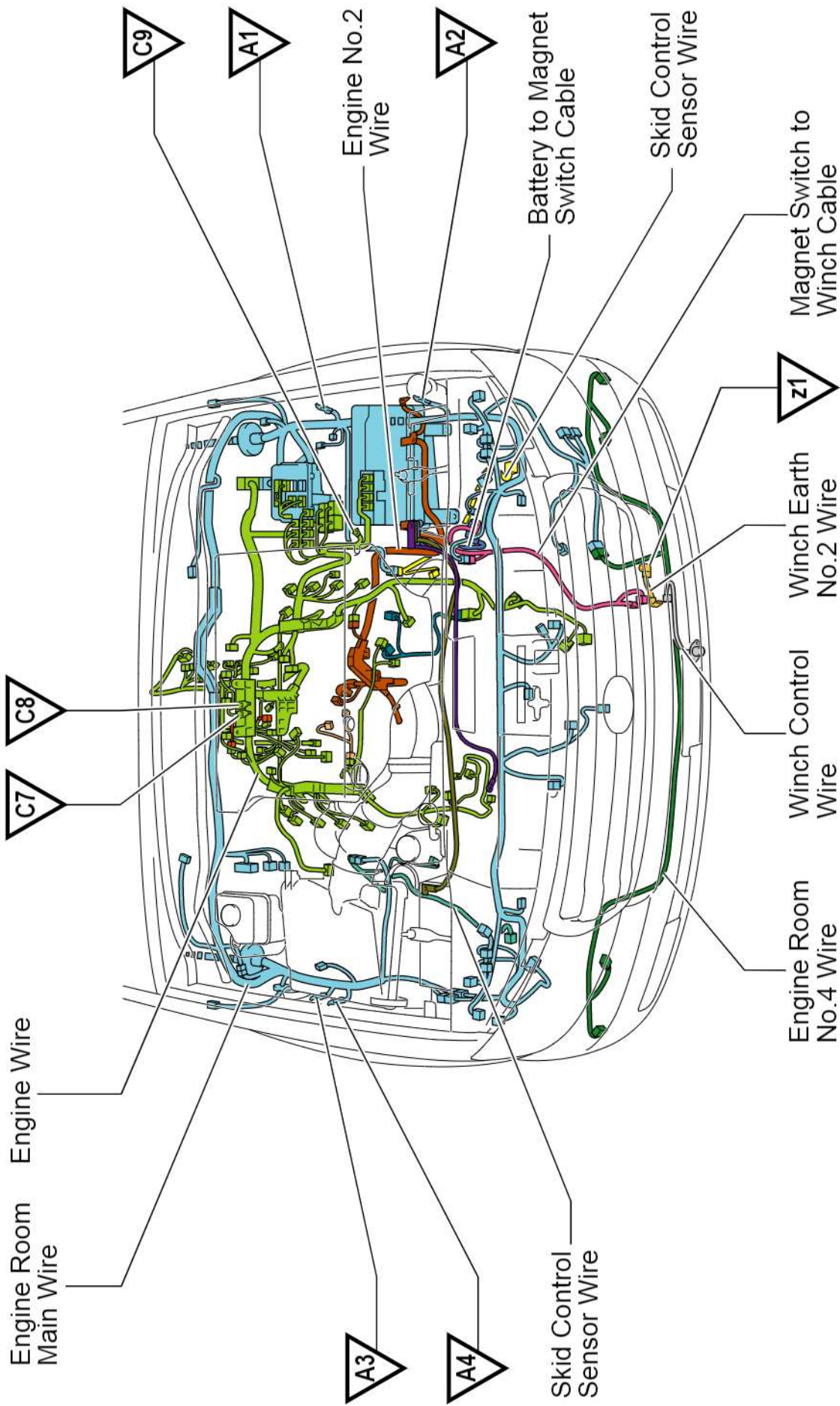

Position of Parts in Engine Compartment <RHD 1VD-FTV>

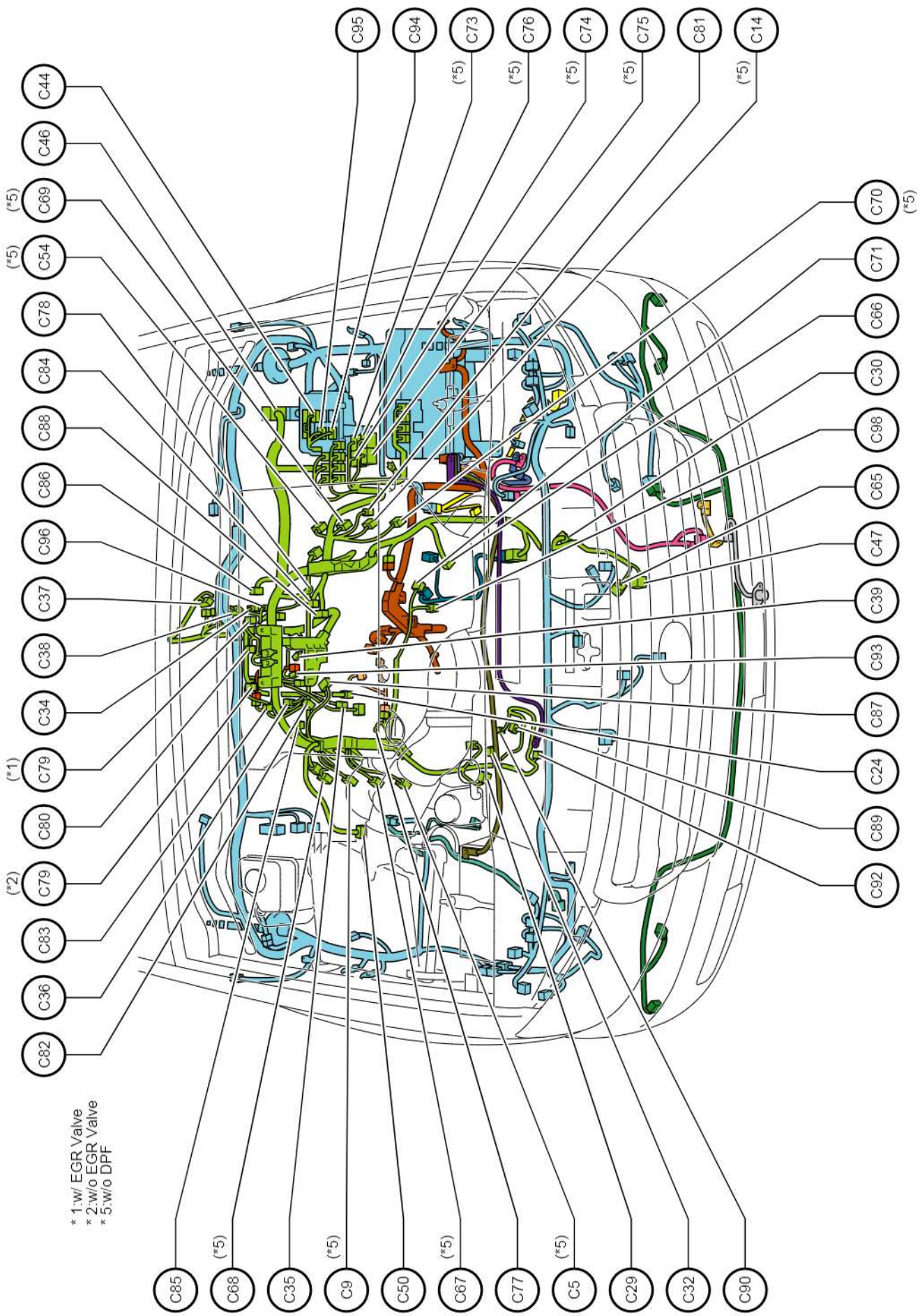

* 1: w/ EGR Valve
 * 2: w/o EGR Valve
 * 5: w/o DPF

C 5	Fuel Injector Assembly No.1
C 9	Fuel Injector Assembly No.5
C 14	Fuel Injector Assembly No.4
C 24	Park/Neutral Position Switch
C 29	Power Steering Oil Pressure Switch
C 30	Cooler Compressor Assembly
C 32	Engine Oil Level Sensor
C 34	Electronically Controlled Transmission Solenoid
C 35	Transmission Revolution Sensor (Turbine)
C 36	Transmission Revolution Sensor (Counter Gear)
C 37	Transfer Shift Actuator Assembly
C 38	Transfer Shift Actuator Assembly
C 39	Back-Up Light Switch Assembly
C 44	Junction Connector
C 46	ECM
C 47	Oil Pressure Sender Gage Assembly
C 50	Mass Air Flow Meter
C 54	Fuel Injector Assembly No.8
C 65	Crankshaft Position Sensor
C 66	Camshaft Position Sensor
C 67	Fuel Injector Assembly No.3
C 68	Fuel Injector Assembly No.7
C 69	Fuel Injector Assembly No.6
C 70	Fuel Injector Assembly No.2
C 71	E.F.I. Engine Coolant Temperature Sensor
C 73	Injector Driver (No.1)
C 74	Injector Driver (No.1)
C 75	Injector Driver (No.2)
C 76	Injector Driver (No.2)
C 77	Glow Plug Assembly
C 78	Glow Plug Assembly
C 79	Intake Air Temperature Sensor
C 80	Diesel Turbo Pressure Sensor
C 81	VSV (ACM)
C 82	Fuel Pressure Sensor
C 83	Diesel Throttle Body Assembly RH
C 84	Diesel Throttle Body Assembly LH
C 85	Diesel Throttle Body Assembly RH
C 86	Diesel Throttle Body Assembly LH
C 87	No.1 EGR Valve Assembly
C 88	No.2 EGR Valve Assembly
C 89	DC Motor and Nozzle Vane Position Sensor RH
C 90	DC Motor and Nozzle Vane Position Sensor RH
C 92	Generator Assembly

Position of Parts in Engine Compartment <RHD 1VD-F-TV>

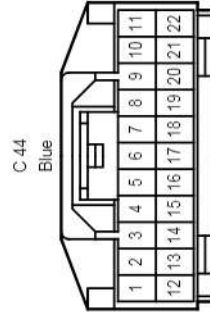
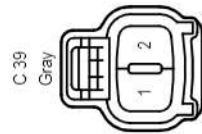
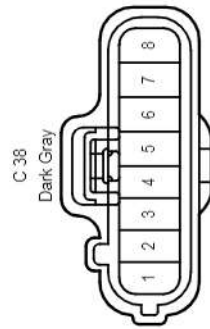
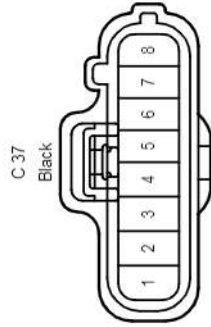
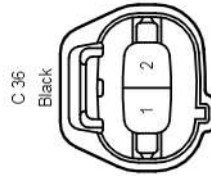
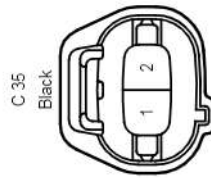
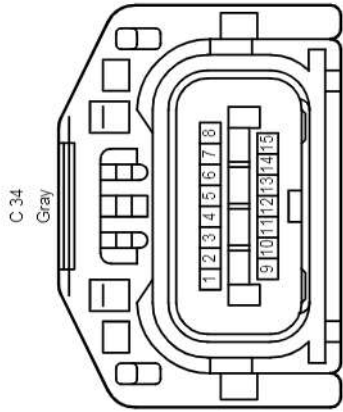
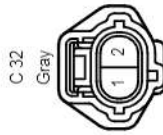
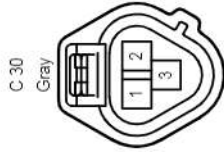
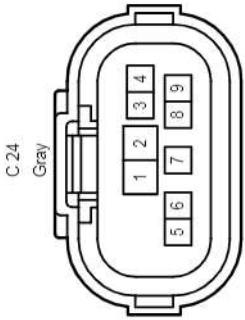
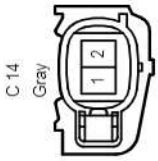
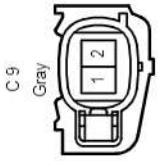
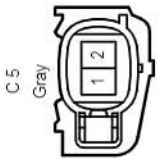

C.46
Black

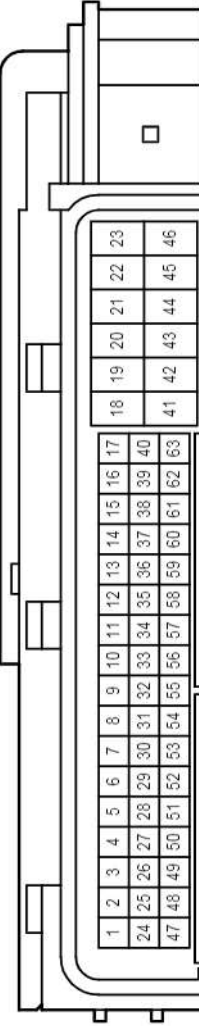

Position of Parts in Engine Compartment <RHD 1VD-F-TV>

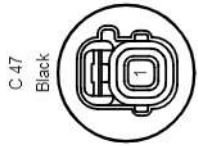

C 47
Black

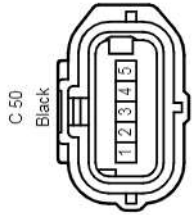

C 50
Black

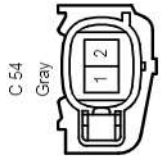

C 54
Gray

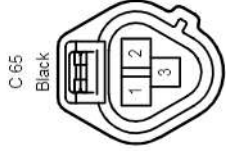

C 65
Black



C 66
Black



C 67
Black

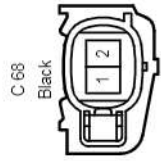

C 68
Black



C 69
Black

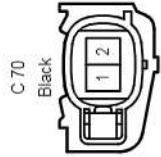

C 70
Black



C 71
Gray

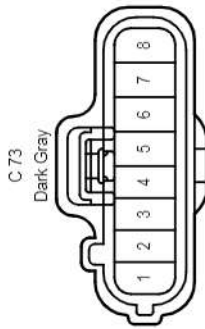

C 73
Dark Gray

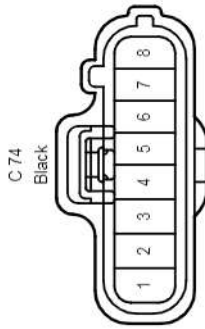

C 74
Black

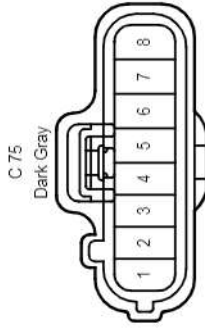

C 75
Dark Gray

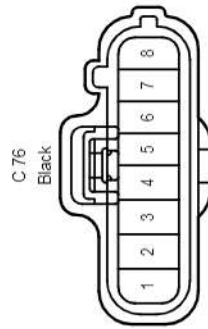

C 76
Black



C 77



C 78

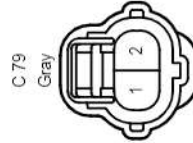

C 79
Gray

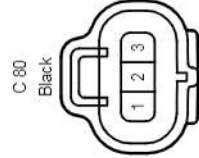

C 80
Black

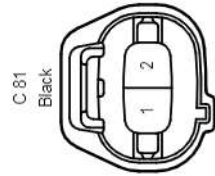

C 81
Black

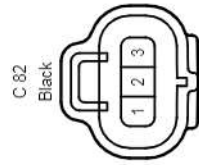

C 82
Black

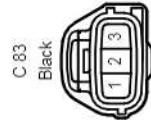

C 83
Black



C 84
Black

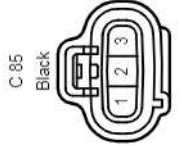

C 85
Black

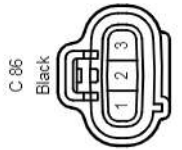

C 86
Black

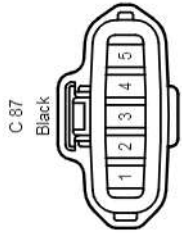

C 87
Black

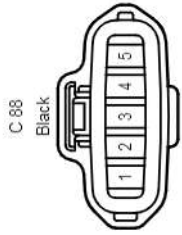

C 88
Black

Position of Parts in Engine Compartment <RHD 1VD-F-TV>

C 94
Gray

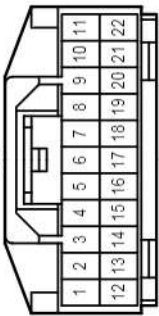

C 95
Black

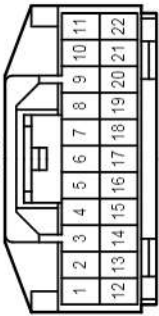

C 96
Gray

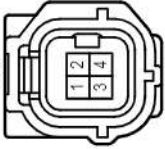

C 98
Gray



Position of Parts in Engine Compartment <RHD 1VD-FTV>

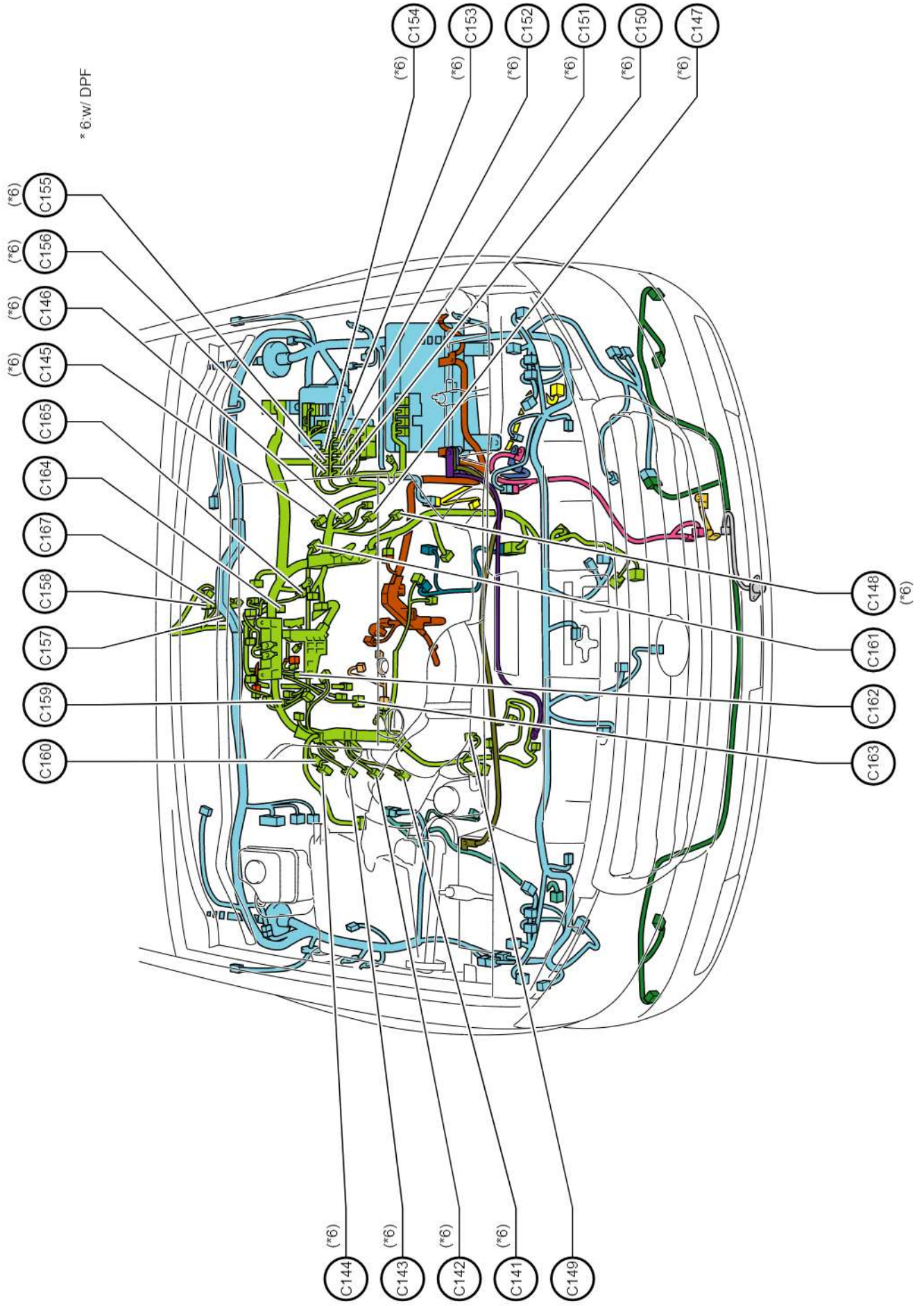

- C 141 Fuel Injector Assembly No.1
- C 142 Fuel Injector Assembly No.3
- C 143 Fuel Injector Assembly No.5
- C 144 Fuel Injector Assembly No.7
- C 145 Fuel Injector Assembly No.8
- C 146 Fuel Injector Assembly No.6
- C 147 Fuel Injector Assembly No.4
- C 148 Fuel Injector Assembly No.2
- C 149 Vane Pump Assembly
- C 150 Injector Driver (No.1)
- C 151 Injector Driver (No.1)
- C 152 Injector Driver (No.1)
- C 153 Injector Driver (No.1)
- C 154 Injector Driver (No.2)
- C 155 Injector Driver (No.2)
- C 156 Injector Driver (No.2)
- C 157 Differential Pressure Sensor LH
- C 158 Air Fuel Ratio Sensor (Bank 2 Sensor 1)
- C 159 Air Fuel Ratio Sensor (Bank 1 Sensor 1)
- C 160 Exhaust Fuel Addition Injector Assembly RH
- C 161 Exhaust Fuel Addition Injector Assembly LH
- C 162 Exhaust Gas Temperature Sensor
- C 163 No.2 Exhaust Gas Temperature Sensor
- C 164 No.3 Exhaust Gas Temperature Sensor
- C 165 No.4 Exhaust Gas Temperature Sensor
- C 167 DPF Temperature Sensor LH (Exhaust Gas Temperature Sensor)

Position of Parts in Engine Compartment <RHD 1VD-F-TV>

C141
Gray

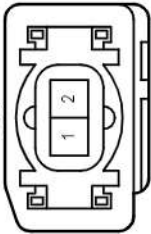

C142
Black

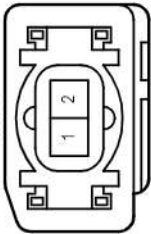

C143
Gray

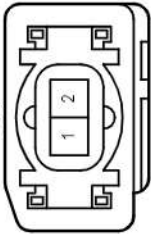

C144
Black

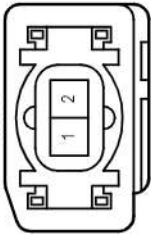

C145
Gray

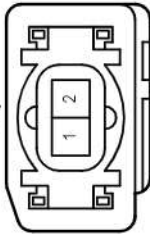

C146
Black

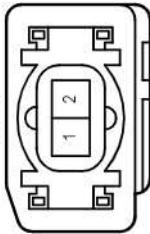

C147
Gray

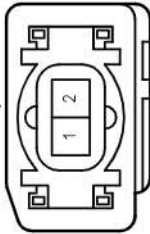

C148
Black

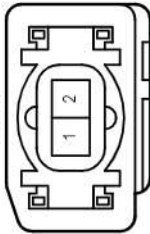

C149
Black



C150
Black

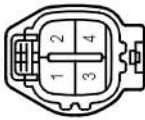

C151
Black

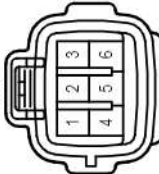

C152
Black

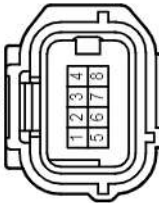

C153
Black



C154
Black

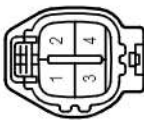

C155
Black

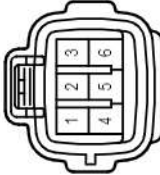

C156
Black

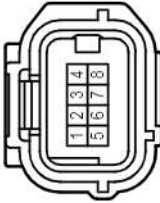

C157
Black



C158
Dark Gray

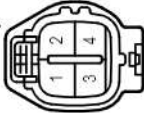

C159
Dark Gray



C160
Black



C161
Black



C162
Gray



C163
Gray



C164
Gray



C165
Gray



C167
Gray



Position of Parts in Engine Compartment <RHD 1VD-FTV>



* 7: Before Jan. 2012 Production
 * 8: From Jan. 2012 Production

A 1	Headlight Assembly LH
A 2	Headlight Assembly LH
A 3	Headlight Assembly LH
A 4	High Pitched Horn Assembly
A 5	Low Pitched Horn Assembly
A 6	Front Airbag Sensor RH
A 7	Front Airbag Sensor LH
A 8	Engine Hood Courtesy Switch
A 8	Engine Hood Courtesy Switch
A 9	Condenser Blower Motor Assembly
A 10	Headlight Assembly RH
A 11	Headlight Assembly RH
A 12	Headlight Assembly RH
A 13	A/C Pressure Sensor
A 14	Ambient Temperature Sensor
A 16	Windshield Washer Motor and Pump Assembly
A 17	Headlight Cleaner Control Relay and Motor
A 19	Security Horn Assembly
A 20	Wireless Door Lock Buzzer
A 22	Windshield Wiper Motor Assembly
A 23	Front Wiper Deicer (Windshield Glass)
A 24	Skid Control ECU with Actuator Assembly
A 25	Skid Control ECU with Actuator Assembly
A 26	Brake Fluid Level Warning Switch (Brake Master Cylinder Reservoir Assembly)
A 32	Noise Filter
A 34	Junction Connector
A 37	Junction Connector
A 42	Winch Main Relay (No.1 Magnet Switch Assembly)
A 43	Level Warning Switch (Fuel Filter Assembly)
A 45	Side Turn Signal Light Assembly LH
A 47	Side Turn Signal Light Assembly RH
A 48	Turbo Motor Driver
A 51	Clogging Switch (Fuel Filter Assembly)
A 52	ECM
A 53	Headlight Assembly LH
A 54	Headlight Assembly LH
A 55	Front Television Camera Assembly
A 57	Headlight Assembly RH
A 58	Headlight Assembly RH
A 59	Headlight Cleaner Control Relay and Motor

Position of Parts in Engine Compartment <RHD 1VD-F-TV>

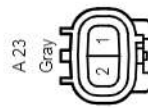
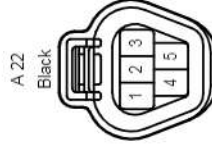
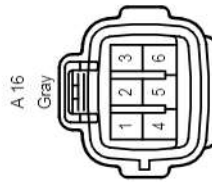
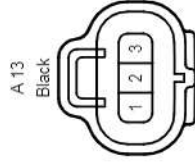
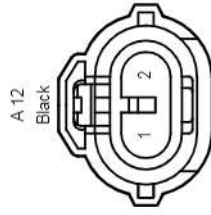
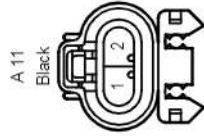
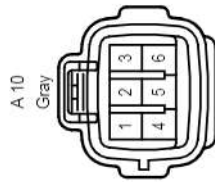
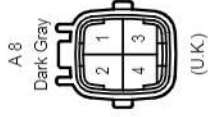
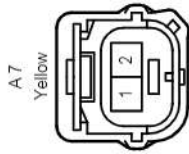
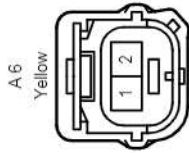
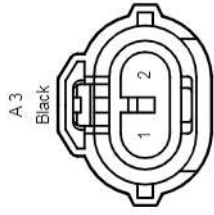
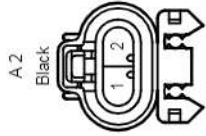
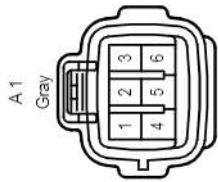

A 24
Black

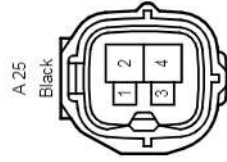
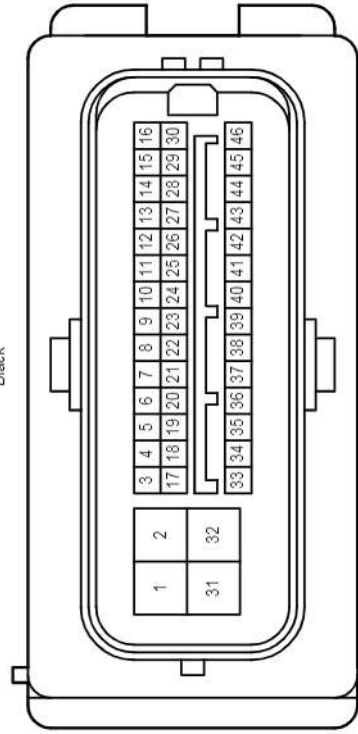

Position of Parts in Engine Compartment <RHD 1VD-F-TV>

A 37
Blue

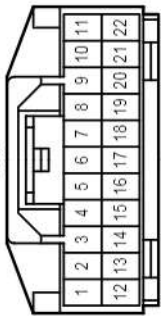

A 42
Black



A 43
Gray



A 45
Gray



A 47
Gray



A 48
Black

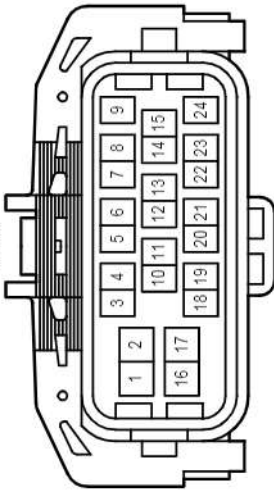

A 51
Black

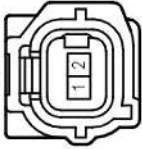

A 52
Black

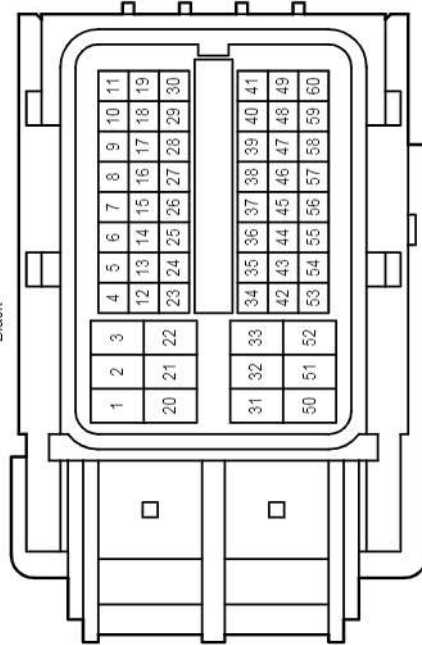

A 53
Black



A 54
Black

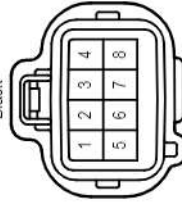

A 55
Black

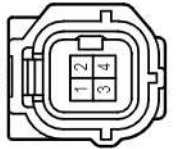

A 57
Black



A 58
Black



A 59
White



Position of Parts in Engine Compartment <RHD 1VD-FTV>

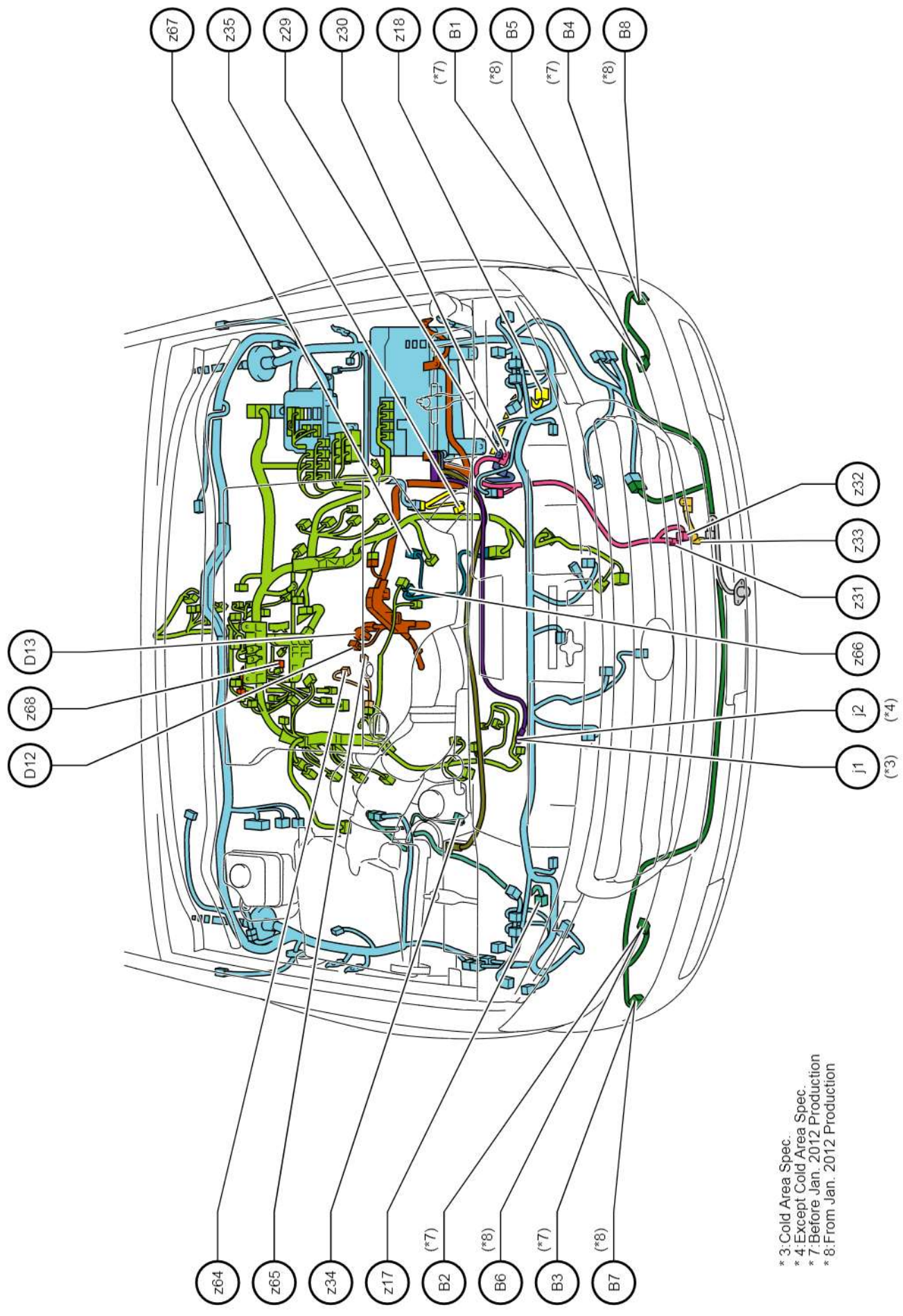

* 3: Cold Area Spec.
 * 4: Except Cold Area Spec.
 * 7: Before Jan. 2012 Production
 * 8: From Jan. 2012 Production

B	1	Fog Light Assembly LH
B	2	Fog Light Assembly RH
B	3	No.1 Ultrasonic Sensor RH
B	4	No.1 Ultrasonic Sensor LH
B	5	Fog Light Assembly LH
B	6	Fog Light Assembly RH
B	7	No.1 Ultrasonic Sensor RH
B	8	No.1 Ultrasonic Sensor LH
D	12	Starter Assembly
D	13	Starter Assembly
j	1	Generator Assembly
j	2	Generator Assembly
z	17	Front Speed Sensor RH
z	18	Front Speed Sensor LH
z	29	Winch Main Relay (No.1 Magnet Switch Assembly)
z	30	Winch Main Relay (No.1 Magnet Switch Assembly)
z	31	With Magnet Switch Winch Motor Assembly
z	32	With Magnet Switch Winch Motor Assembly
z	33	With Magnet Switch Winch Motor Assembly
z	34	Front Height Control Sensor Sub-Assembly RH
z	35	Front Height Control Sensor Sub-Assembly LH
z	64	Suction Control Valve (Injection or Supply Pump Assembly)
z	65	Fuel Temperature Sensor (Injection or Supply Pump Assembly)
z	66	DC Motor and Nozzle Vane Position Sensor LH
z	67	DC Motor and Nozzle Vane Position Sensor LH
z	68	Pressure Discharge Valve

Position of Parts in Engine Compartment <RHD 1VD-F-TV>

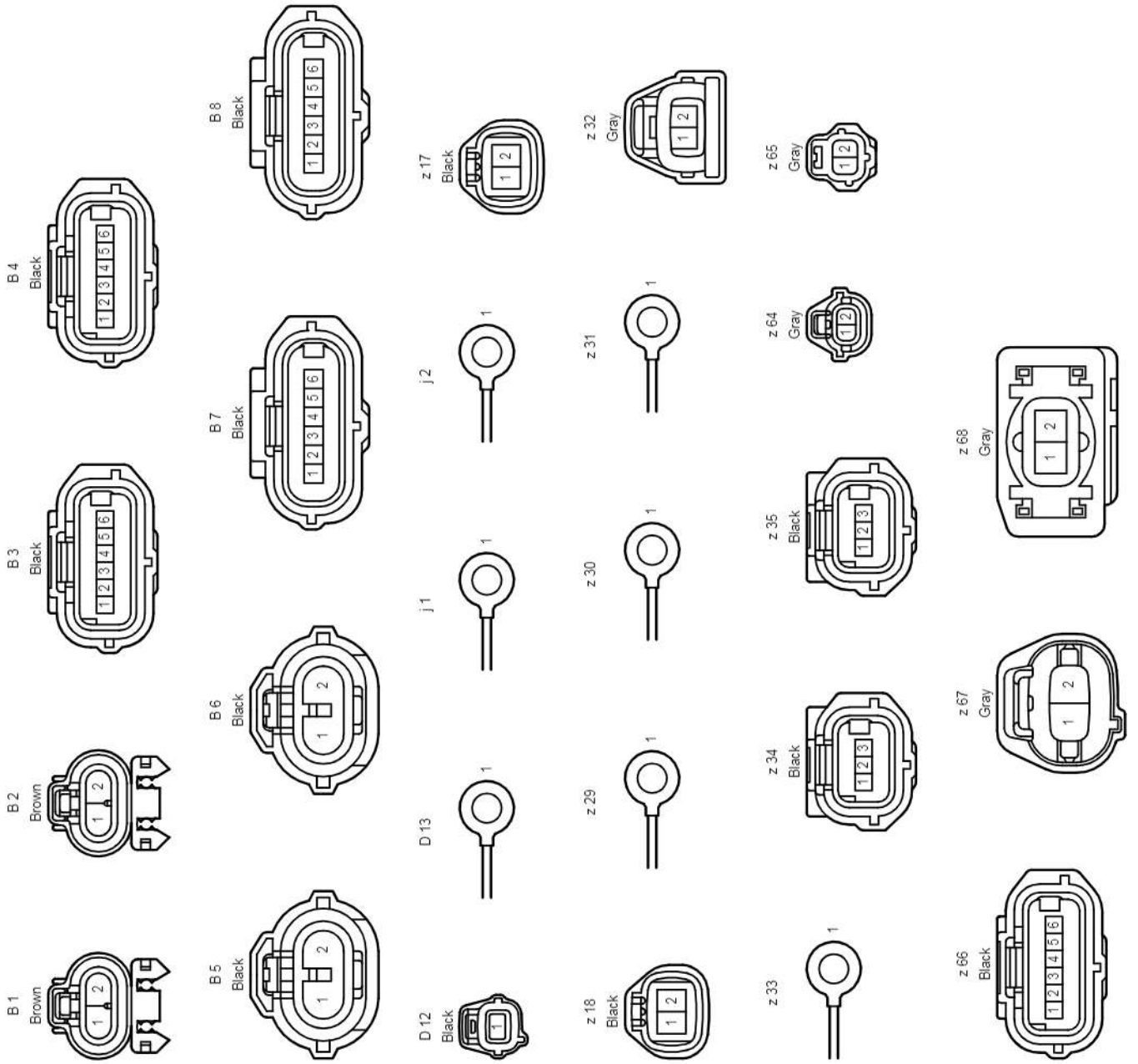

* 1:Lifgate Type Body
* 2:Swing Type Body

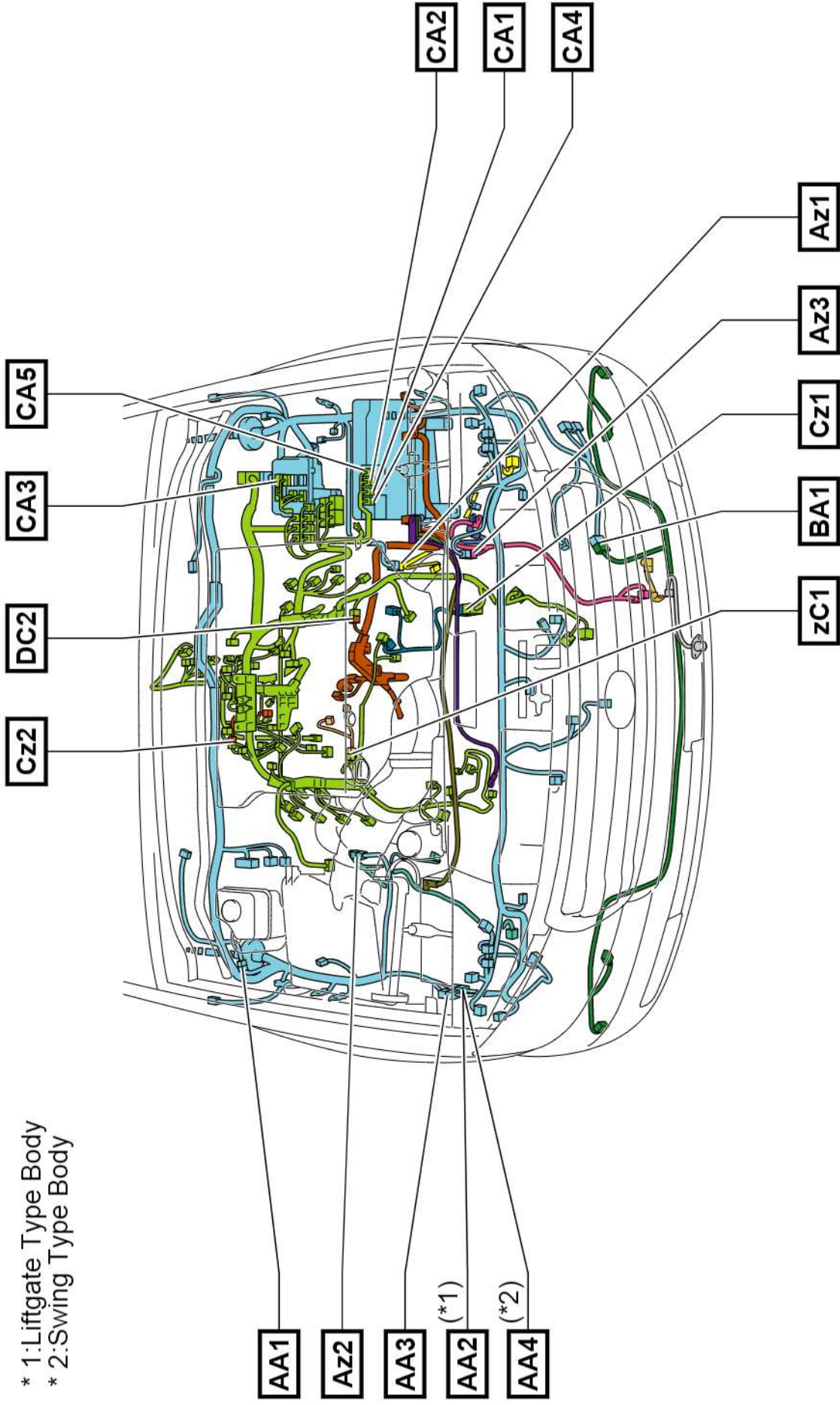

Wire and Wire in Engine Compartment <RHD 1VD-FTV>

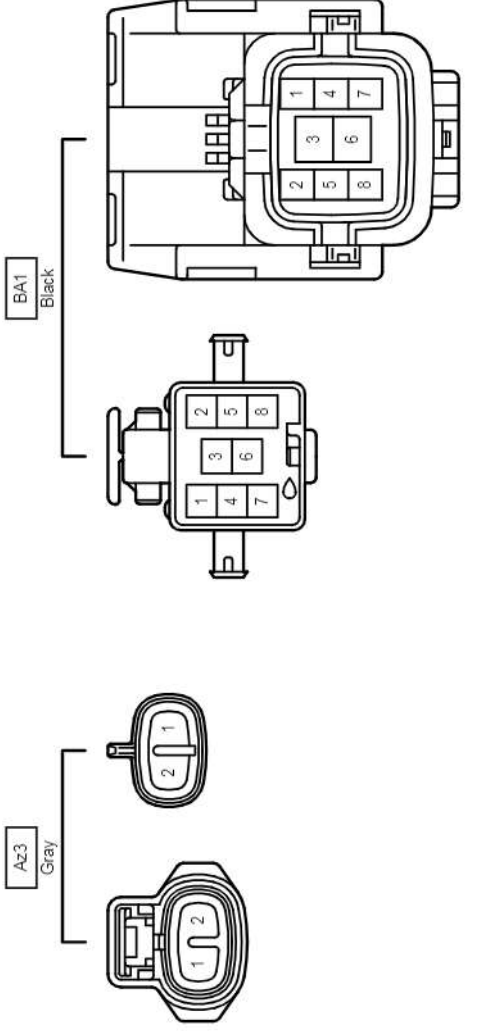
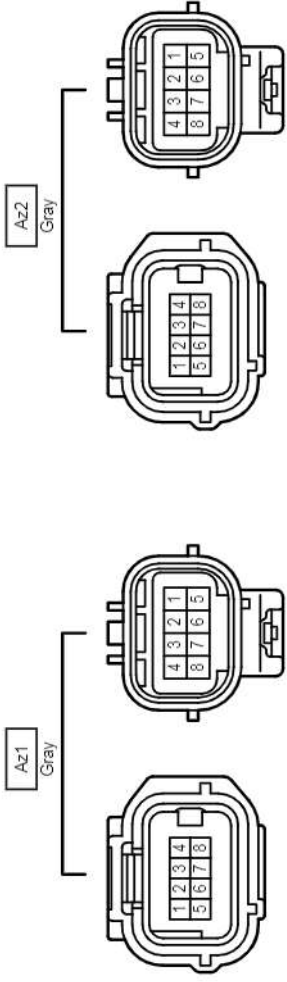
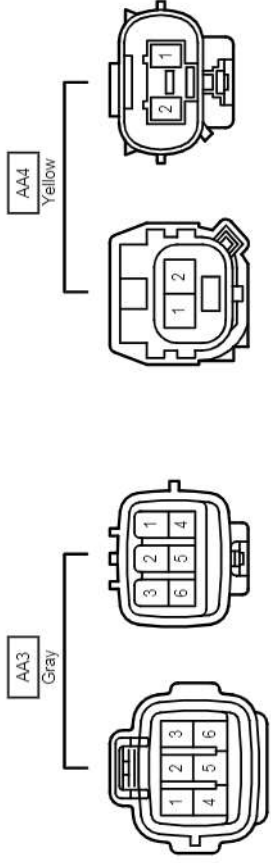
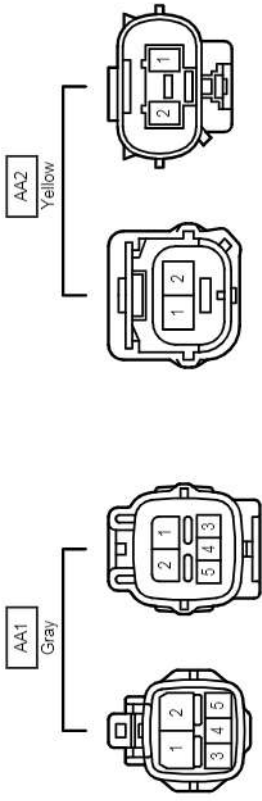

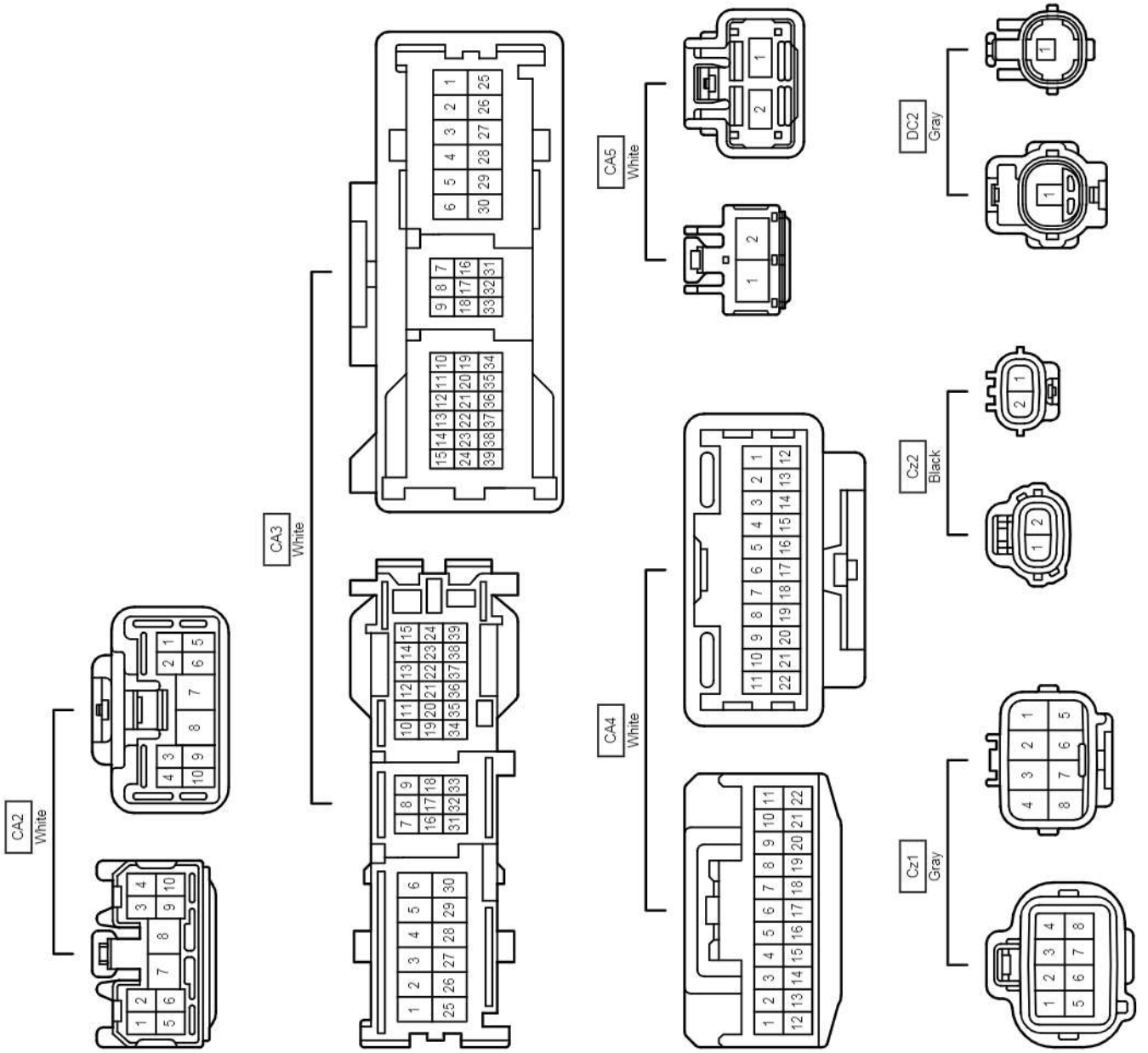

Ground Points in Engine Compartment <LHD 2UZ-FE>

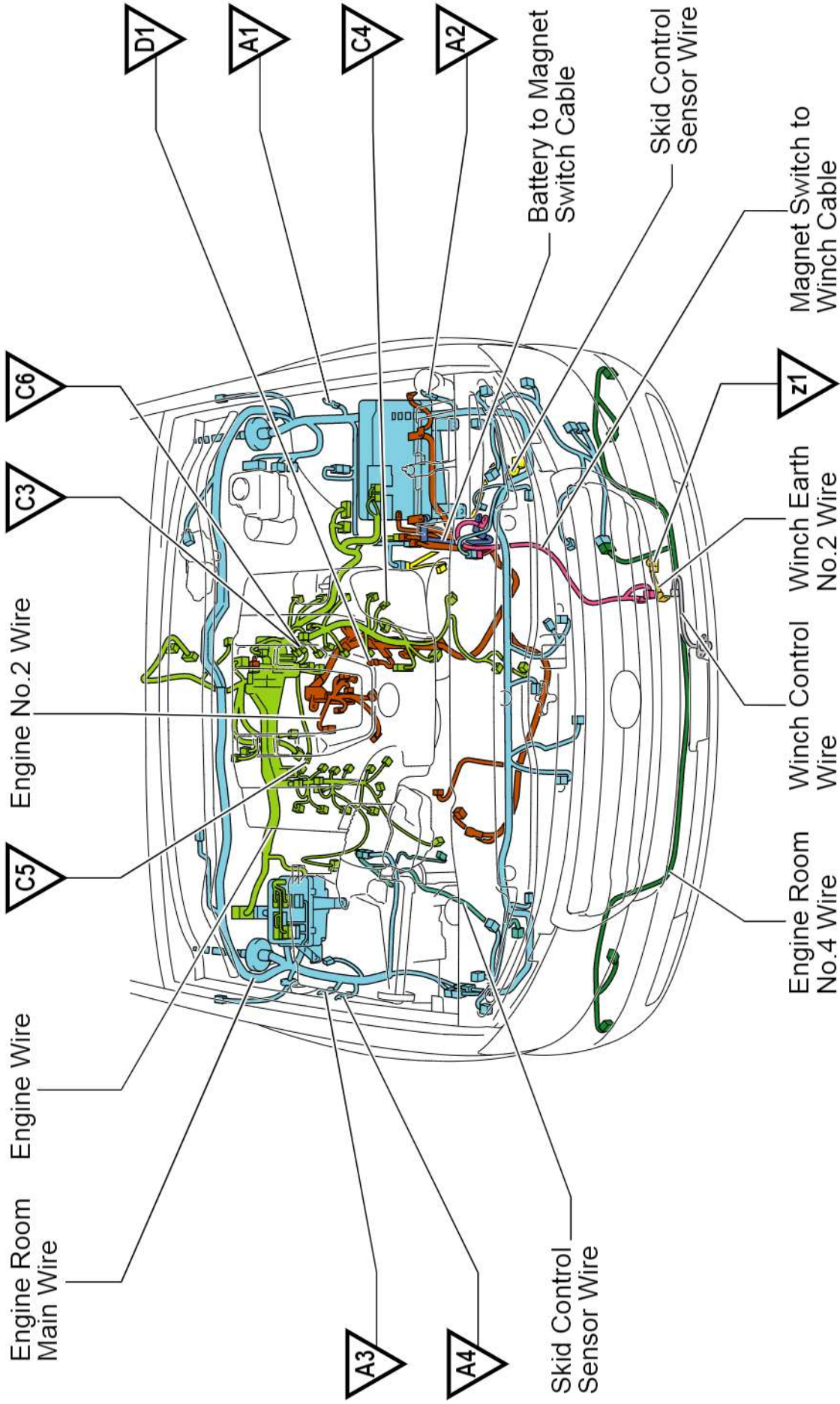

Position of Parts in Engine Compartment <LHD 2UZ-FE>

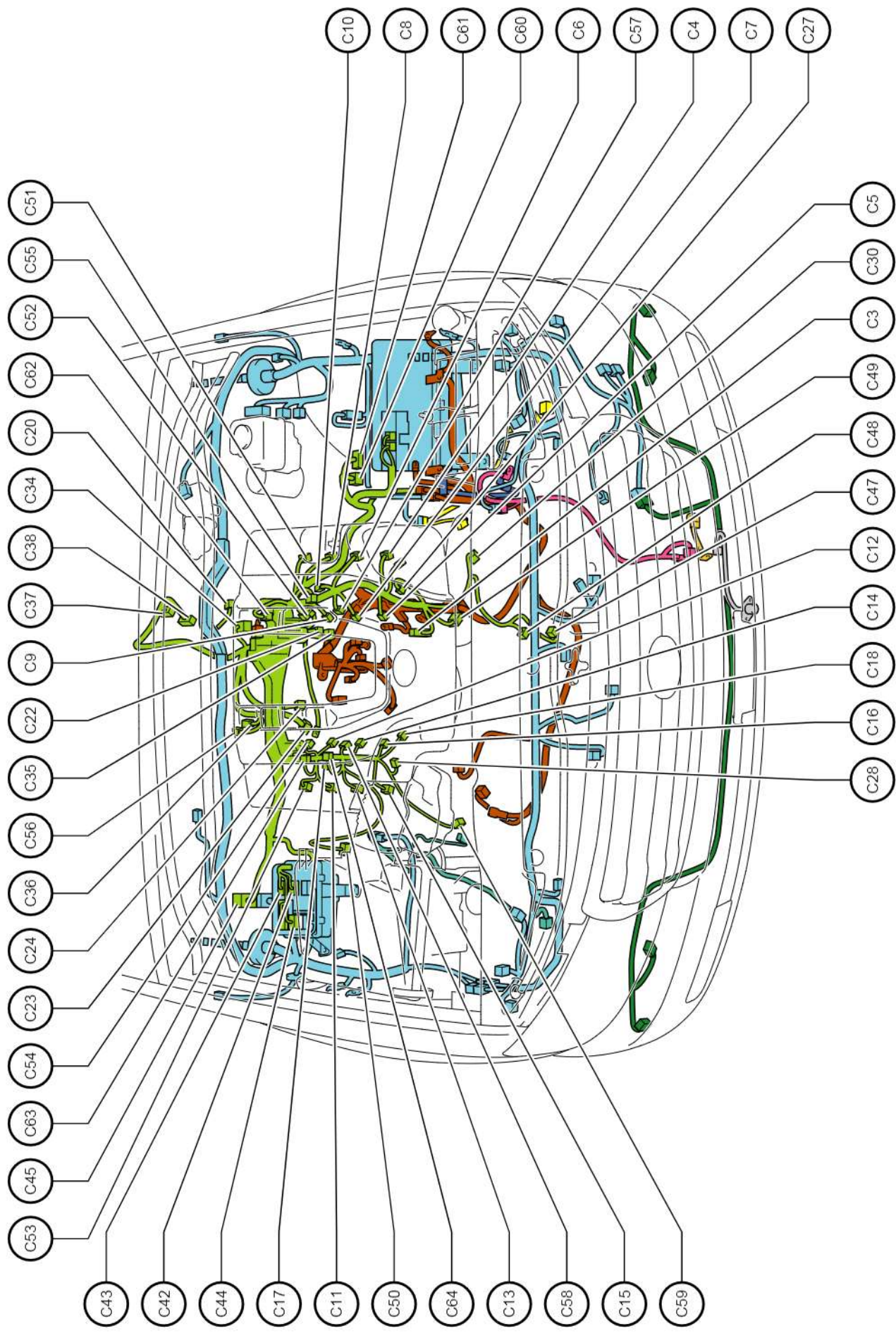

C 3	Throttle Body Assembly
C 4	Ignition Coil Assembly No.1
C 5	Fuel Injector Assembly No.1
C 6	Ignition Coil Assembly No.3
C 7	Fuel Injector Assembly No.3
C 8	Ignition Coil Assembly No.5
C 9	Fuel Injector Assembly No.5
C 10	Noise Filter (Ignition Bank 1)
C 11	Ignition Coil Assembly No.6
C 12	Fuel Injector Assembly No.6
C 13	Ignition Coil Assembly No.4
C 14	Fuel Injector Assembly No.4
C 15	Ignition Coil Assembly No.2
C 16	Fuel Injector Assembly No.2
C 17	Noise Filter (Ignition Bank 2)
C 18	E.F.I. Engine Coolant Temperature Sensor
C 20	Oxygen Sensor (Bank 1 Sensor 2)
C 22	Air Fuel Ratio Sensor (Bank 1 Sensor 1)
C 23	Air Fuel Ratio Sensor (Bank 2 Sensor 1)
C 24	Park/Neutral Position Switch
C 27	Camshaft Timing Oil Control Valve (Bank 1 Intake Side)
C 28	Camshaft Timing Oil Control Valve (Bank 2 Intake Side)
C 30	Cooler Compressor Assembly
C 34	Electronically Controlled Transmission Solenoid
C 35	Transmission Revolution Sensor (Turbine)
C 36	Transmission Revolution Sensor (Counter Gear)
C 37	Transfer Shift Actuator Assembly
C 38	Transfer Shift Actuator Assembly
C 42	Junction Connector
C 43	Junction Connector
C 44	Junction Connector
C 45	ECM
C 47	Oil Pressure Sender Gage Assembly
C 48	Crankshaft Position Sensor
C 49	Camshaft Position Sensor
C 50	Mass Air Flow Meter
C 51	Ignition Coil Assembly No.7
C 52	Fuel Injector Assembly No.7
C 53	Ignition Coil Assembly No.8
C 54	Fuel Injector Assembly No.8
C 55	Purge VSV
C 56	Oxygen Sensor (Bank 2 Sensor 2)
C 57	VVT Sensor (Bank 1)
C 58	VVT Sensor (Bank 2)

Position of Parts in Engine Compartment <LHD 2UZ-FE>

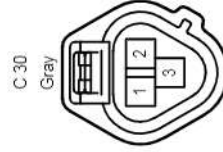
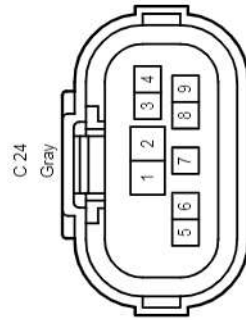
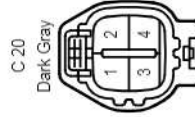
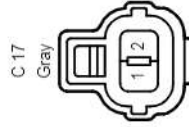
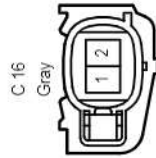
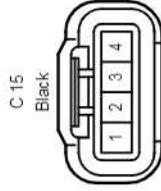
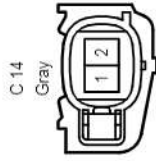
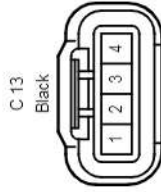
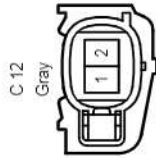
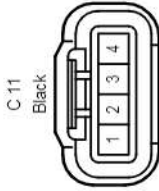
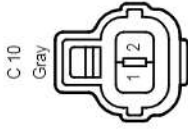
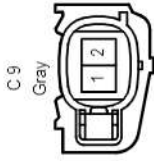
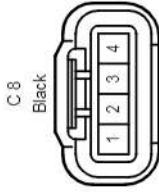
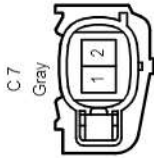
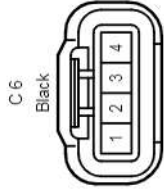
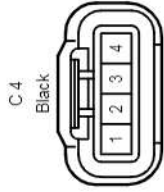
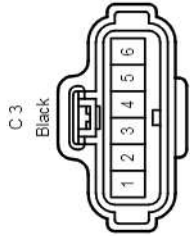

C.34
Gray

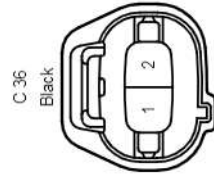
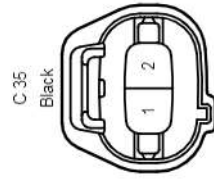

Position of Parts in Engine Compartment <LHD 2UZ-FE>

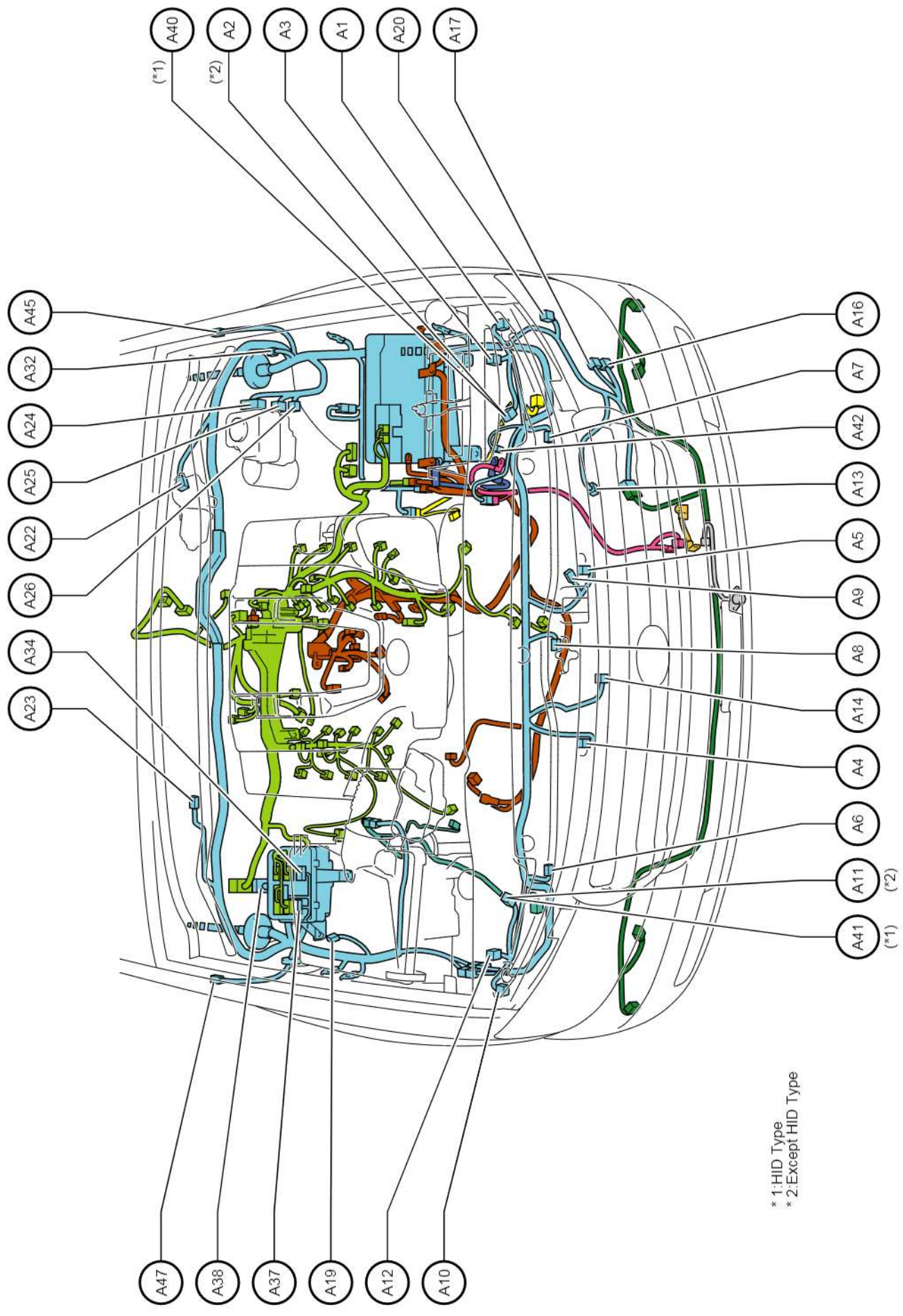

* 1:HID Type
 * 2:Except HID Type

- A 1 Headlight Assembly LH
- A 2 Headlight Assembly LH
- A 3 Headlight Assembly LH
- A 4 High Pitched Horn Assembly
- A 5 Low Pitched Horn Assembly
- A 6 Front Airbag Sensor RH
- A 7 Front Airbag Sensor LH
- A 8 Engine Hood Courtesy Switch
- A 8 Engine Hood Courtesy Switch
- A 9 Condenser Blower Motor Assembly
- A 10 Headlight Assembly RH
- A 11 Headlight Assembly RH
- A 12 Headlight Assembly RH
- A 13 A/C Pressure Sensor
- A 14 Ambient Temperature Sensor
- A 16 Windshield Washer Motor and Pump Assembly
- A 17 Headlight Cleaner Control Relay and Motor
- A 19 Security Horn Assembly
- A 20 Wireless Door Lock Buzzer
- A 22 Windshield Wiper Motor Assembly
- A 23 Front Wiper Deicer (Windshield Glass)
- A 24 Skid Control ECU with Actuator Assembly
- A 25 Skid Control ECU with Actuator Assembly
- A 26 Brake Fluid Level Warning Switch (Brake Master Cylinder Reservoir Assembly)
- A 32 Noise Filter
- A 34 Junction Connector
- A 37 Junction Connector
- A 38 ECM
- A 40 Headlight Assembly LH
- A 41 Headlight Assembly RH
- A 42 Winch Main Relay (No.1 Magnet Switch Assembly)
- A 45 Side Turn Signal Light Assembly LH
- A 47 Side Turn Signal Light Assembly RH

Position of Parts in Engine Compartment <LHD 2UZ-FE>

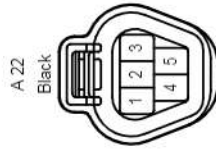
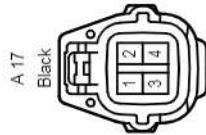
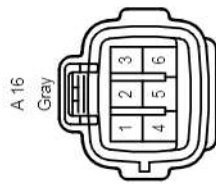
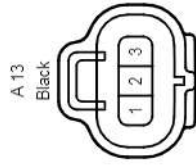
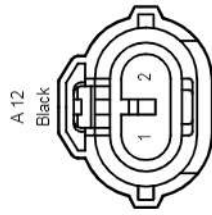
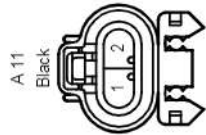
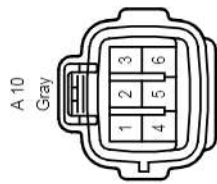
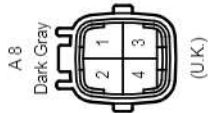
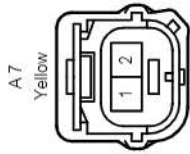
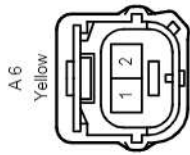
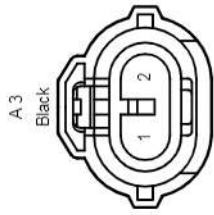
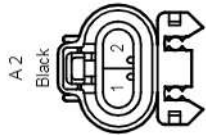
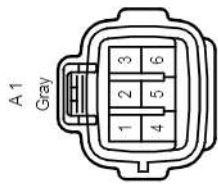

A 24
Black

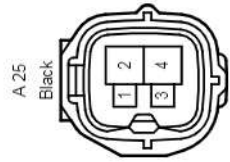
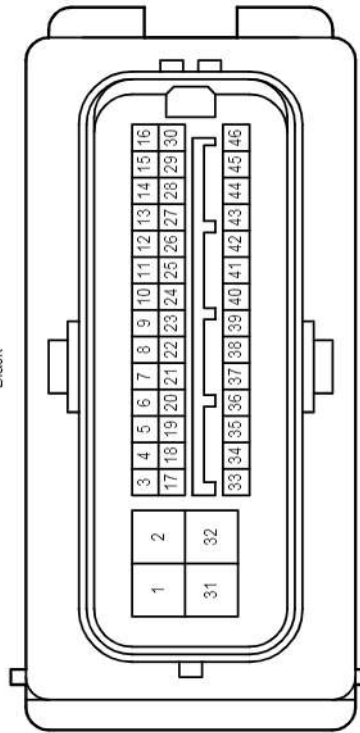

Position of Parts in Engine Compartment <LHD 2UZ-FE>

A 37
Blue

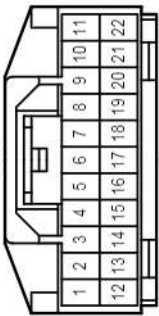

A 38
Black

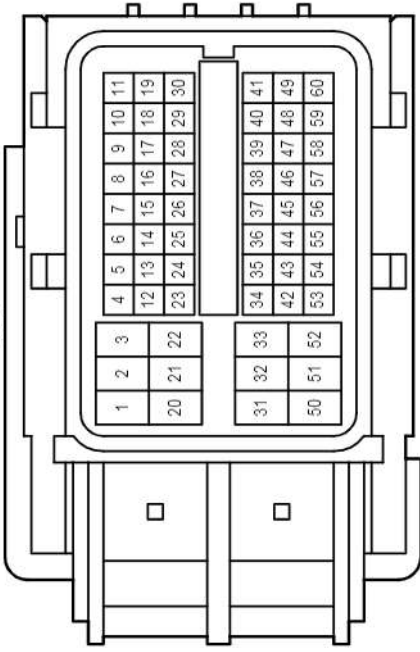

A 40
Gray



A 41
Gray



A 42
Black



A 45
Gray



A 47
Gray



Position of Parts in Engine Compartment <LHD 2UZ-FE>

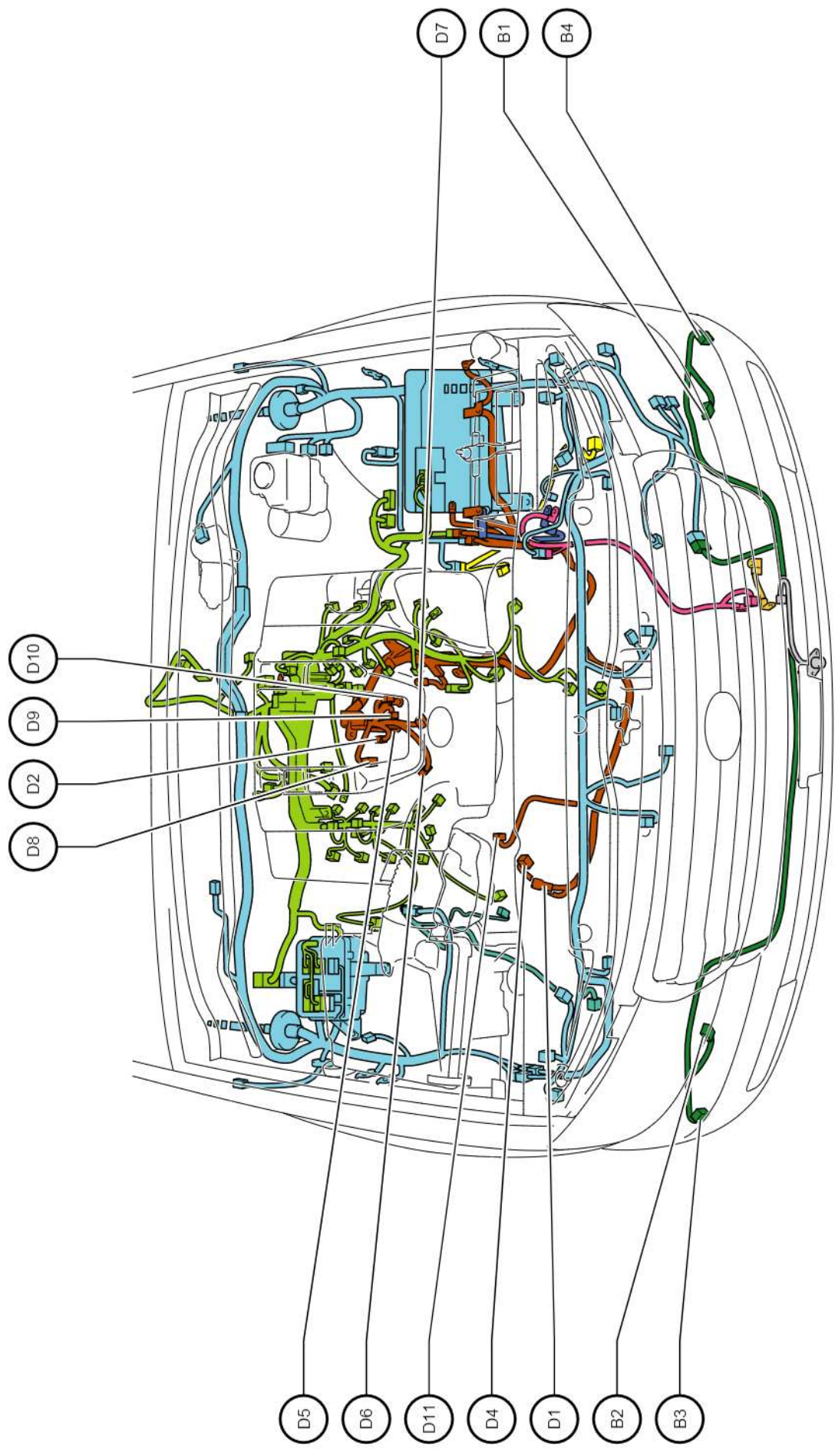

- B 1 Fog Light Assembly LH
- B 2 Fog Light Assembly RH
- B 3 No.1 Ultrasonic Sensor RH
- B 4 No.1 Ultrasonic Sensor LH

- D 1 Generator Assembly
- D 2 Starter Assembly
- D 4 Generator Assembly
- D 5 Starter Assembly
- D 6 Knock Control Sensor (Bank 2)
- D 7 Knock Control Sensor (Bank 1)
- D 8 Air Pump Assembly
- D 9 Air Pressure Sensor
- D 10 Air Switching Valve
- D 11 Engine Oil Level Sensor

Position of Parts in Engine Compartment <LHD 2UZ-FE>

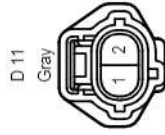
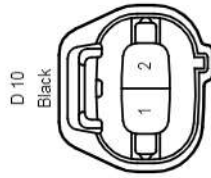
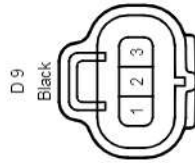
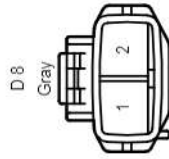
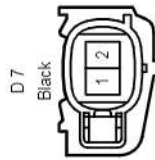
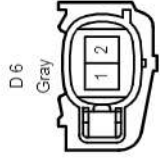
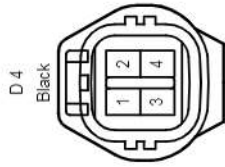
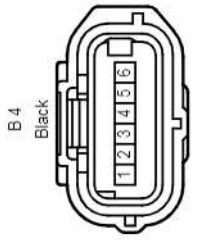
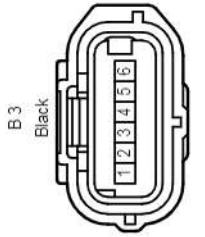
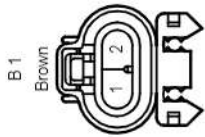

Position of Parts in Engine Compartment <LHD 2UZ-FE>

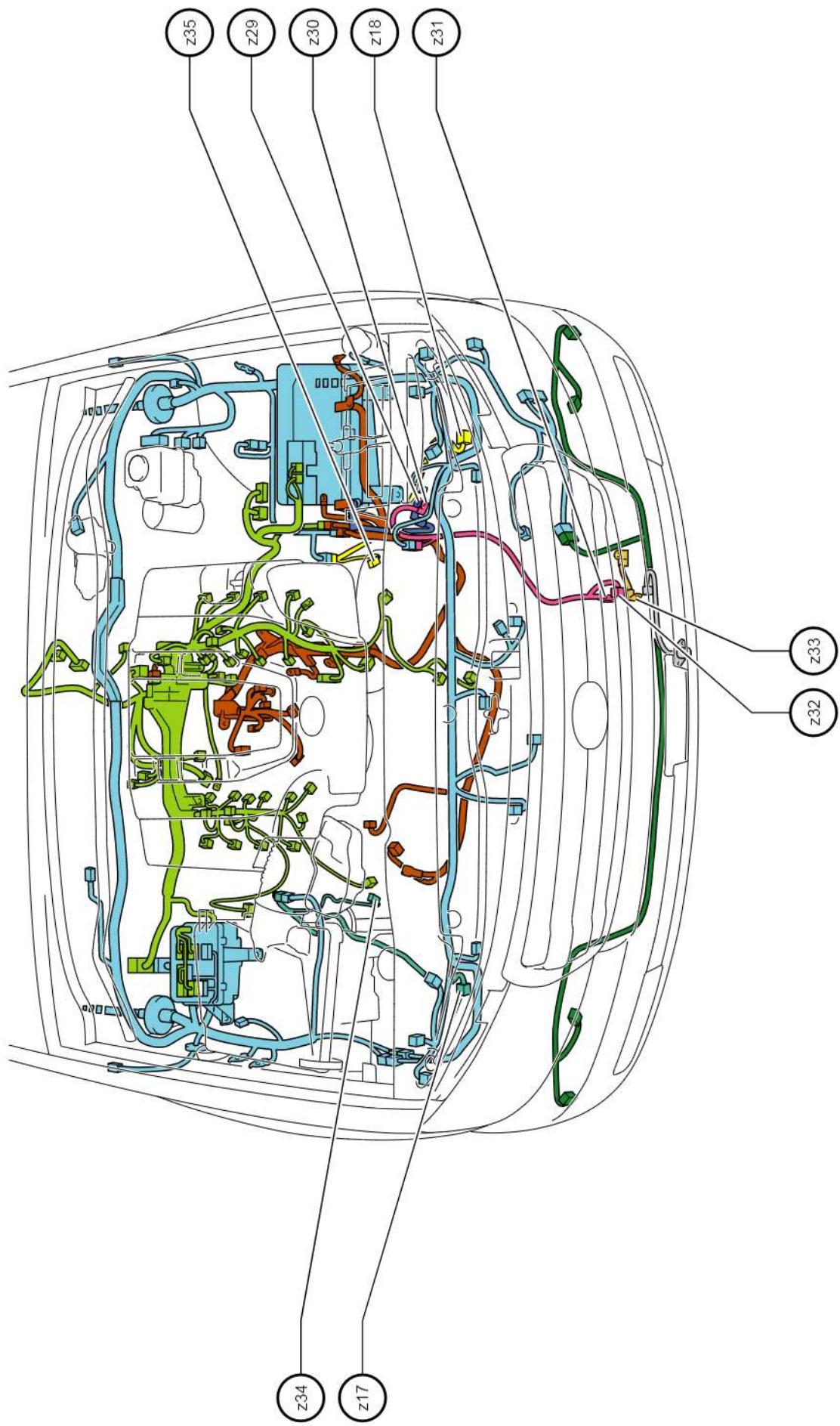

Position of Parts in Engine Compartment <LHD 2UZ-FE>

- z 17 Front Speed Sensor RH
- z 18 Front Speed Sensor LH
- z 29 Winch Main Relay (No.1 Magnet Switch Assembly)
- z 30 Winch Main Relay (No.1 Magnet Switch Assembly)
- z 31 With Magnet Switch Winch Motor Assembly
- z 32 With Magnet Switch Winch Motor Assembly
- z 33 With Magnet Switch Winch Motor Assembly
- z 34 Front Height Control Sensor Sub-Assembly RH
- z 35 Front Height Control Sensor Sub-Assembly LH

Position of Parts in Engine Compartment <LHD 2UZ-FE>

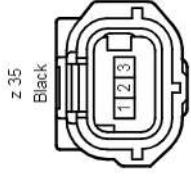
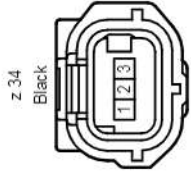
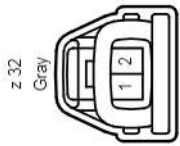
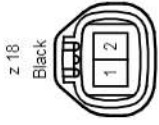

Wire and Wire in Engine Compartment <LHD 2UZ-FE>

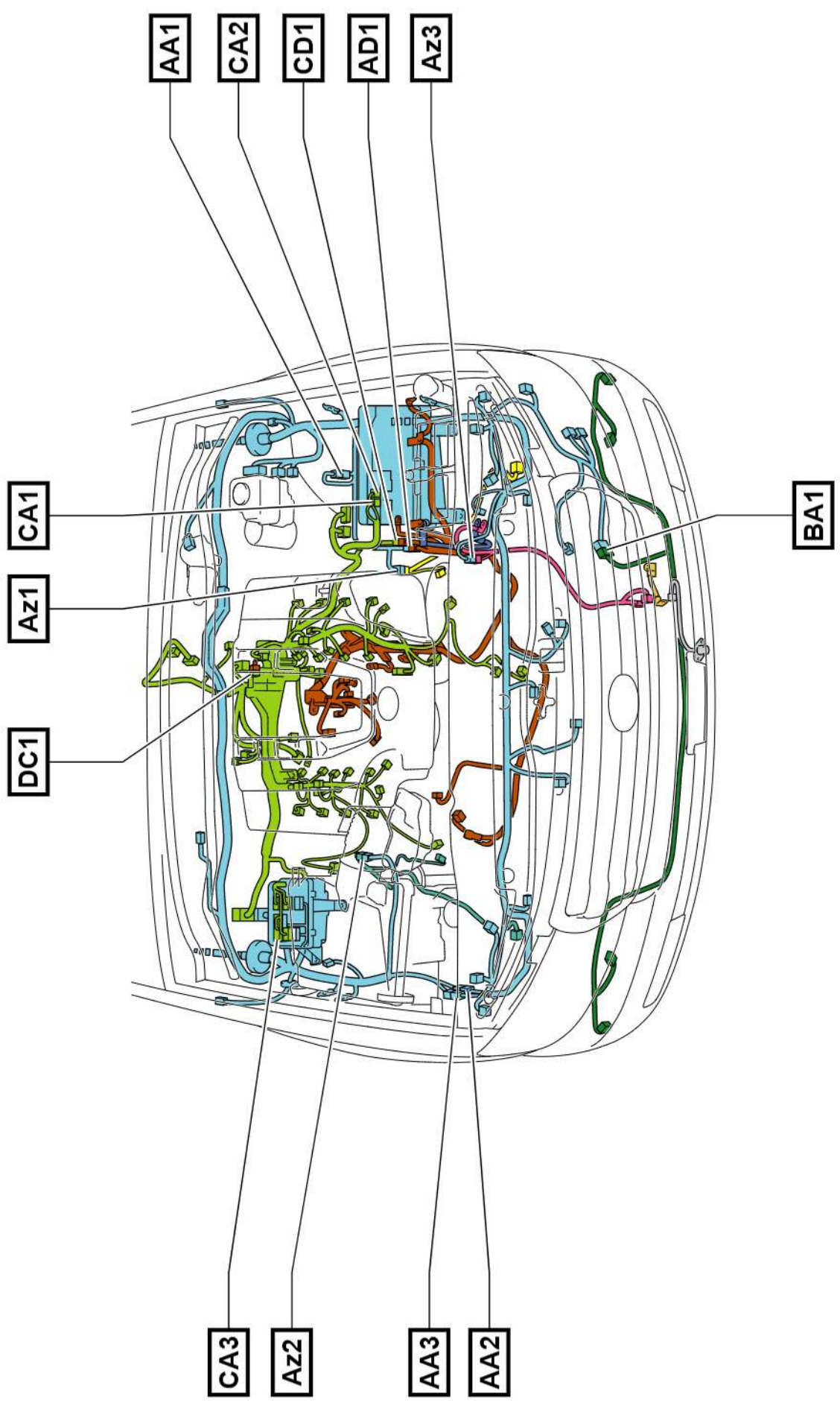

Wire and Wire in Engine Compartment <LHD 2UZ-FE>

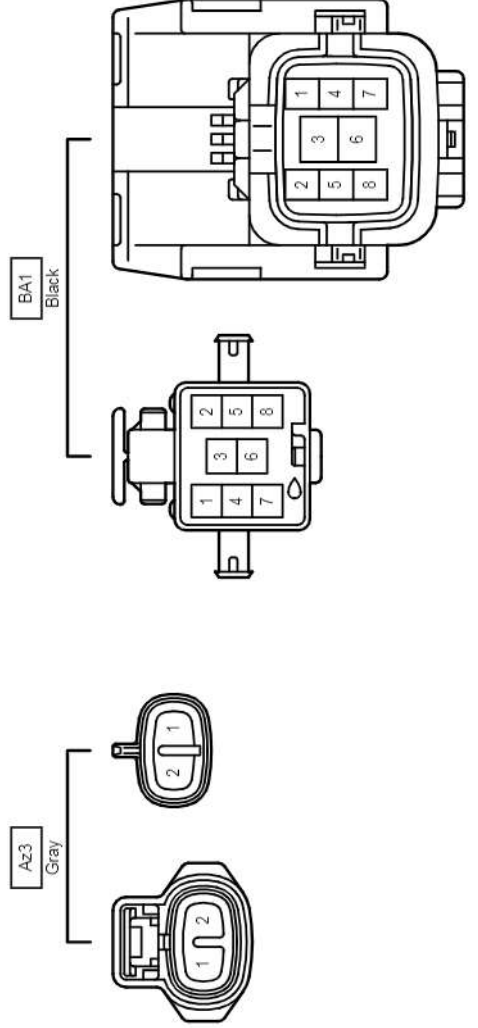
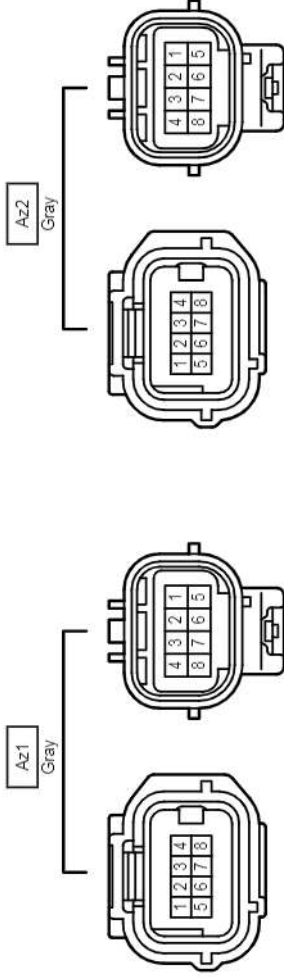
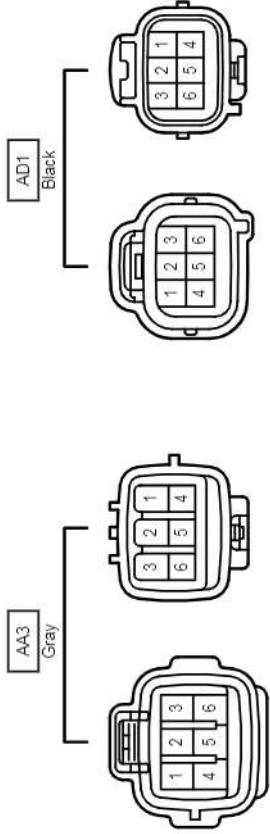
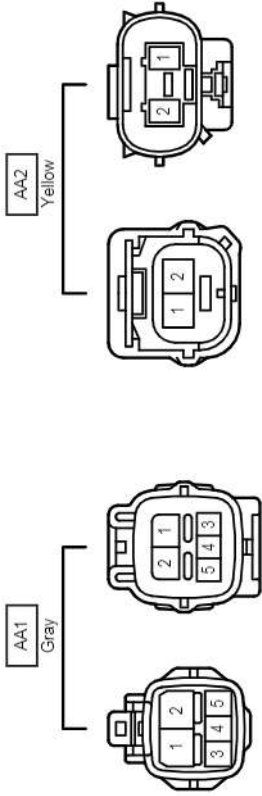

Wire and Wire in Engine Compartment <LHD 2UZ-FE>

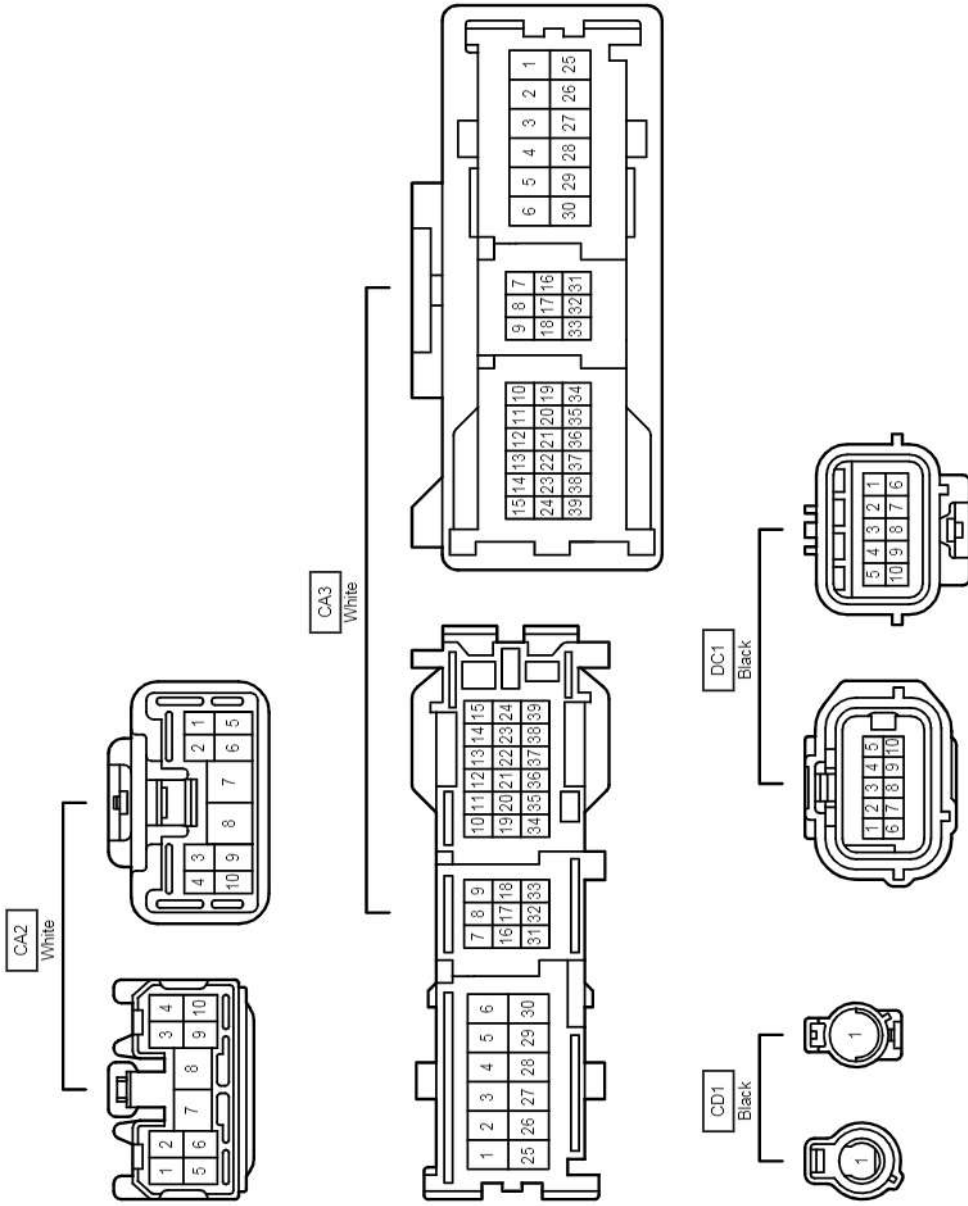

Ground Points in Engine Compartment <RHD 2UZ-FE>

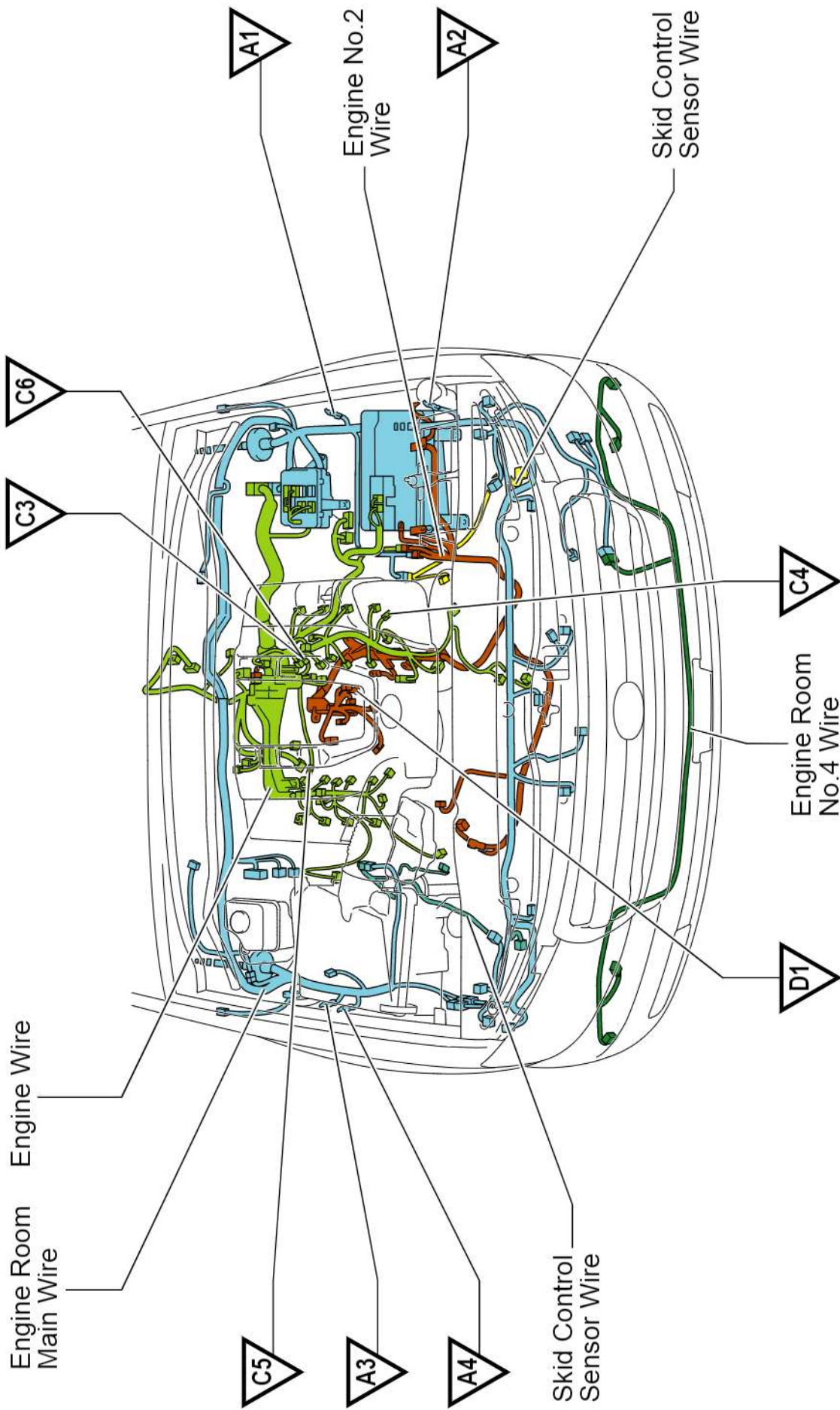

Position of Parts in Engine Compartment <RHD 2UZ-FE>

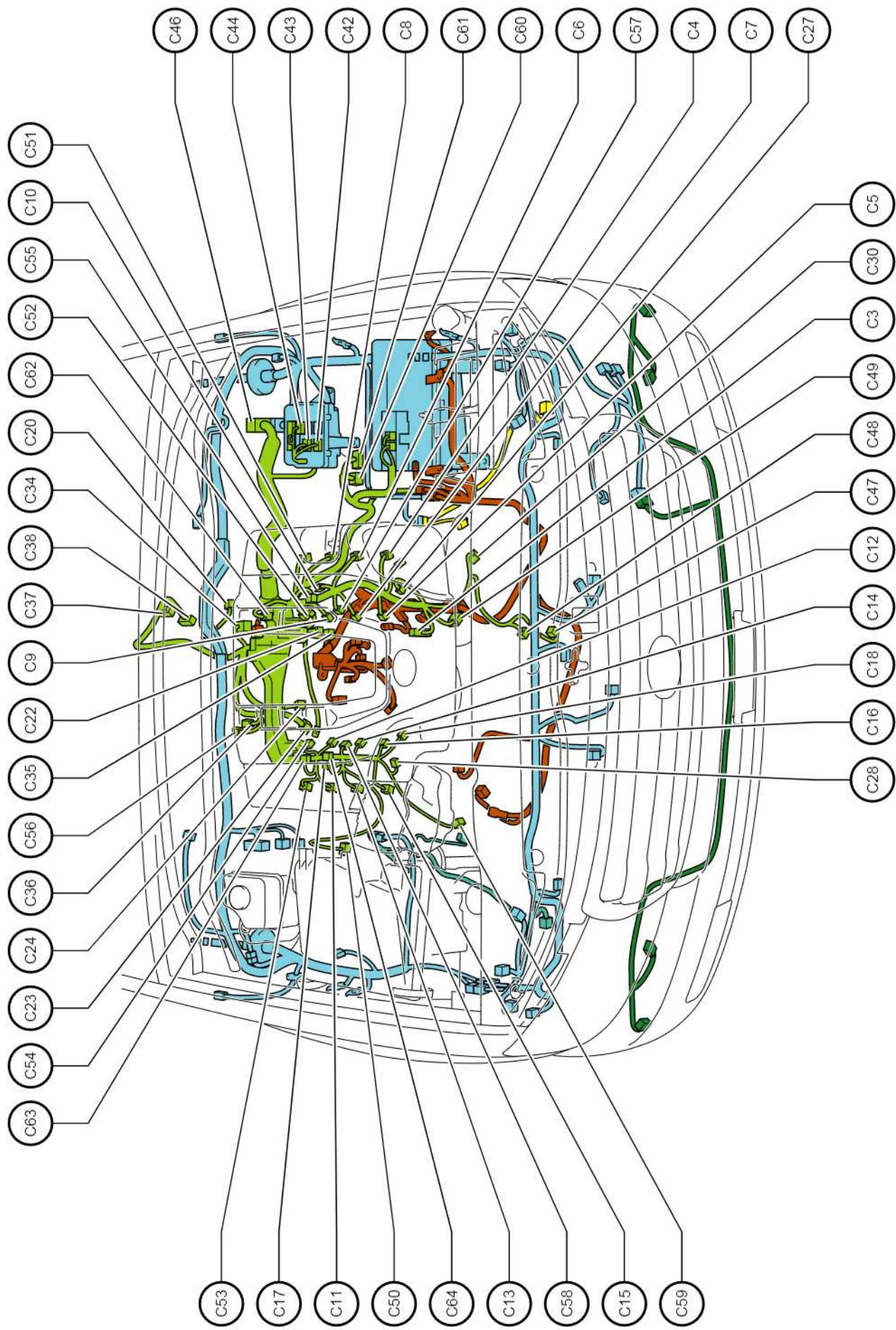

C 3	Throttle Body Assembly
C 4	Ignition Coil Assembly No.1
C 5	Fuel Injector Assembly No.1
C 6	Ignition Coil Assembly No.3
C 7	Fuel Injector Assembly No.3
C 8	Ignition Coil Assembly No.5
C 9	Fuel Injector Assembly No.5
C 10	Noise Filter (Ignition Bank 1)
C 11	Ignition Coil Assembly No.6
C 12	Fuel Injector Assembly No.6
C 13	Ignition Coil Assembly No.4
C 14	Fuel Injector Assembly No.4
C 15	Ignition Coil Assembly No.2
C 16	Fuel Injector Assembly No.2
C 17	Noise Filter (Ignition Bank 2)
C 18	E.F.I. Engine Coolant Temperature Sensor
C 20	Oxygen Sensor (Bank 1 Sensor 2)
C 22	Air Fuel Ratio Sensor (Bank 1 Sensor 1)
C 23	Air Fuel Ratio Sensor (Bank 2 Sensor 1)
C 24	Park/Neutral Position Switch
C 27	Camshaft Timing Oil Control Valve (Bank 1 Intake Side)
C 28	Camshaft Timing Oil Control Valve (Bank 2 Intake Side)
C 30	Cooler Compressor Assembly
C 34	Electronically Controlled Transmission Solenoid
C 35	Transmission Revolution Sensor (Turbine)
C 36	Transmission Revolution Sensor (Counter Gear)
C 37	Transfer Shift Actuator Assembly
C 38	Transfer Shift Actuator Assembly
C 42	Junction Connector
C 43	Junction Connector
C 44	Junction Connector
C 46	ECM
C 47	Oil Pressure Sender Gage Assembly
C 48	Crankshaft Position Sensor
C 49	Camshaft Position Sensor
C 50	Mass Air Flow Meter
C 51	Ignition Coil Assembly No.7
C 52	Fuel Injector Assembly No.7
C 53	Ignition Coil Assembly No.8
C 54	Fuel Injector Assembly No.8
C 55	Purge VSV
C 56	Oxygen Sensor (Bank 2 Sensor 2)
C 57	VVT Sensor (Bank 1)
C 58	VVT Sensor (Bank 2)

Position of Parts in Engine Compartment <RHD 2UZ-FE>

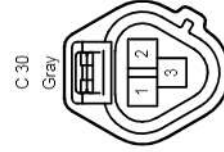
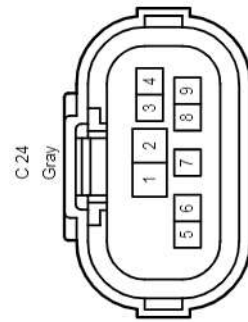
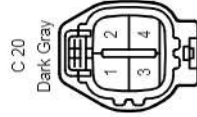
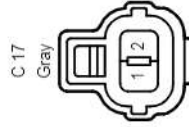
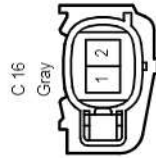
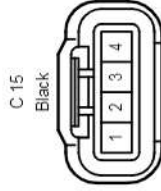
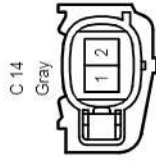
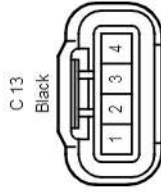
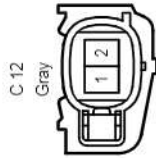
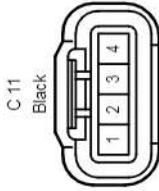
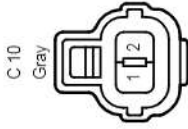
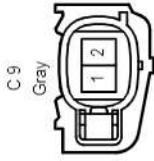
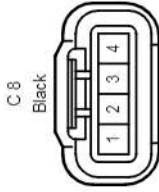
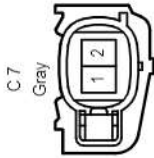
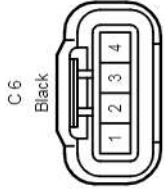
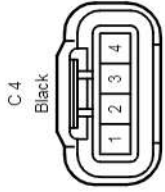
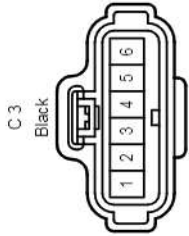

C.34
Gray

C.35
Black

C.36
Black

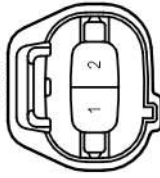
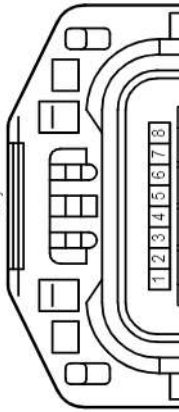

Position of Parts in Engine Compartment <RHD 2UZ-FE>

C 43
White

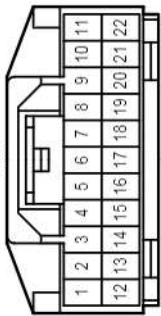

C 44
Blue

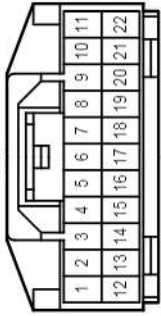

C 46
Black

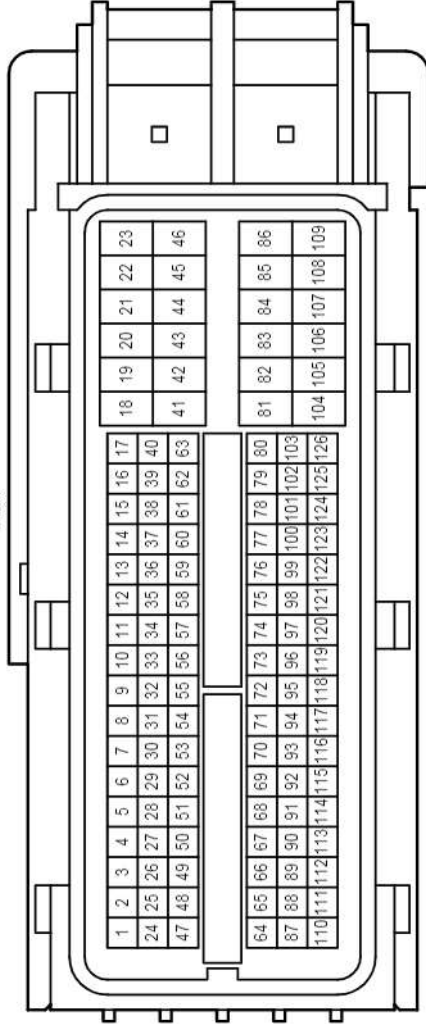

C 47
Black



C 48
Dark Gray



C 49
Gray

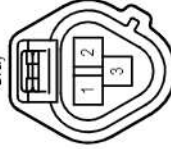

C 50
Black

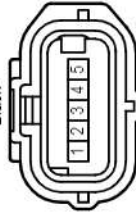

C 51
Black

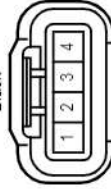

C 52
Gray



C 53
Black

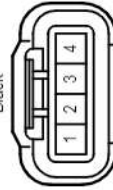

C 54
Gray



C 55
Black



C 56
Dark Gray



C 57
Dark Gray



C 58
Dark Gray



C 59
Gray



C 60
Black



Position of Parts in Engine Compartment <RHD 2UZ-FE>

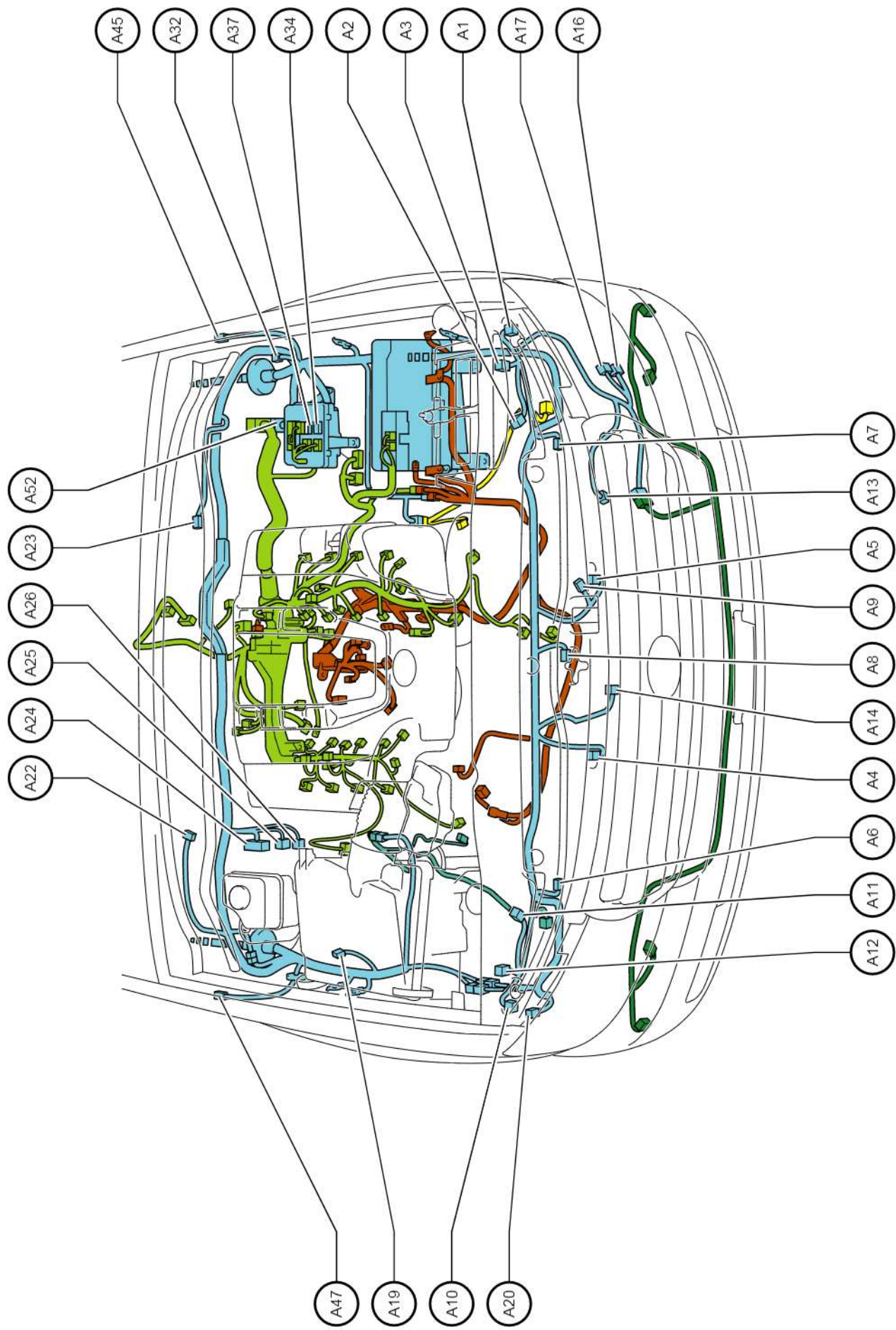

A	1	Headlight Assembly LH
A	2	Headlight Assembly LH
A	3	Headlight Assembly LH
A	4	High Pitched Horn Assembly
A	5	Low Pitched Horn Assembly
A	6	Front Airbag Sensor RH
A	7	Front Airbag Sensor LH
A	8	Engine Hood Courtesy Switch
A	8	Engine Hood Courtesy Switch
A	9	Condenser Blower Motor Assembly
A	10	Headlight Assembly RH
A	11	Headlight Assembly RH
A	12	Headlight Assembly RH
A	13	A/C Pressure Sensor
A	14	Ambient Temperature Sensor
A	16	Windshield Washer Motor and Pump Assembly
A	17	Headlight Cleaner Control Relay and Motor
A	19	Security Horn Assembly
A	20	Wireless Door Lock Buzzer
A	22	Windshield Wiper Motor Assembly
A	23	Front Wiper Deicer (Windshield Glass)
A	24	Skid Control ECU with Actuator Assembly
A	25	Skid Control ECU with Actuator Assembly
A	26	Brake Fluid Level Warning Switch (Brake Master Cylinder Reservoir Assembly)
A	32	Noise Filter
A	34	Junction Connector
A	37	Junction Connector
A	45	Side Turn Signal Light Assembly LH
A	47	Side Turn Signal Light Assembly RH
A	52	ECM

Position of Parts in Engine Compartment <RHD 2UZ-FE>

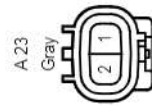
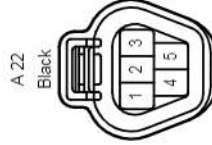
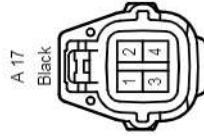
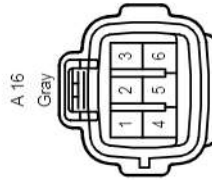
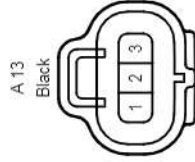
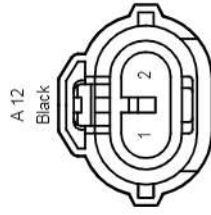
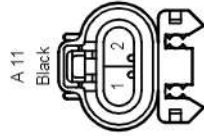
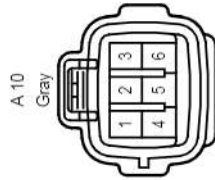
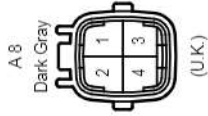
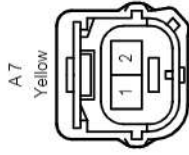
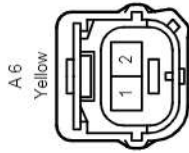
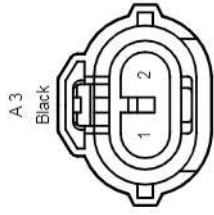
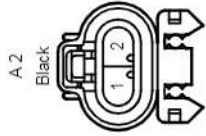
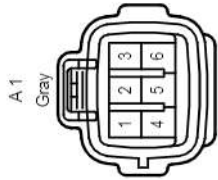

A 24
Black

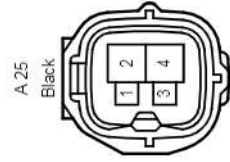
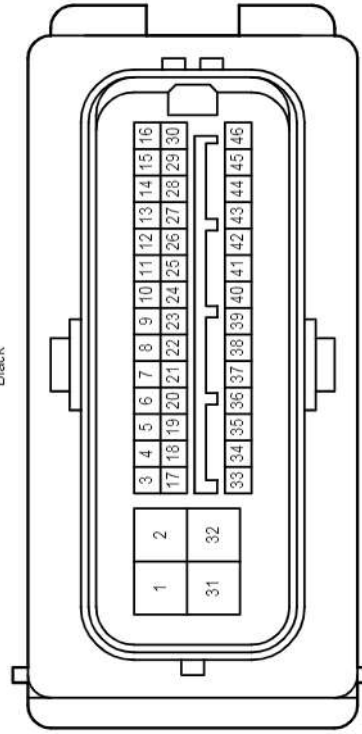

Position of Parts in Engine Compartment <RHD 2UZ-FE>

A 37
Blue

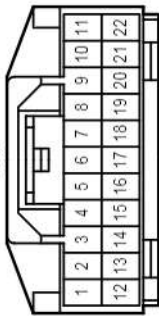

A 45
Gray



A 47
Gray



A 52
Black

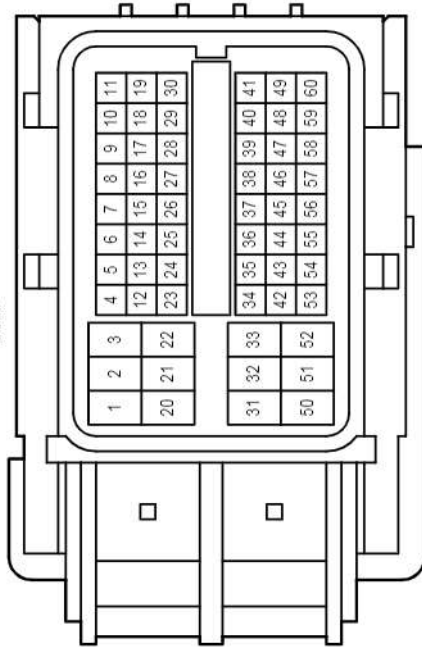

Position of Parts in Engine Compartment <RHD 2UZ-FE>

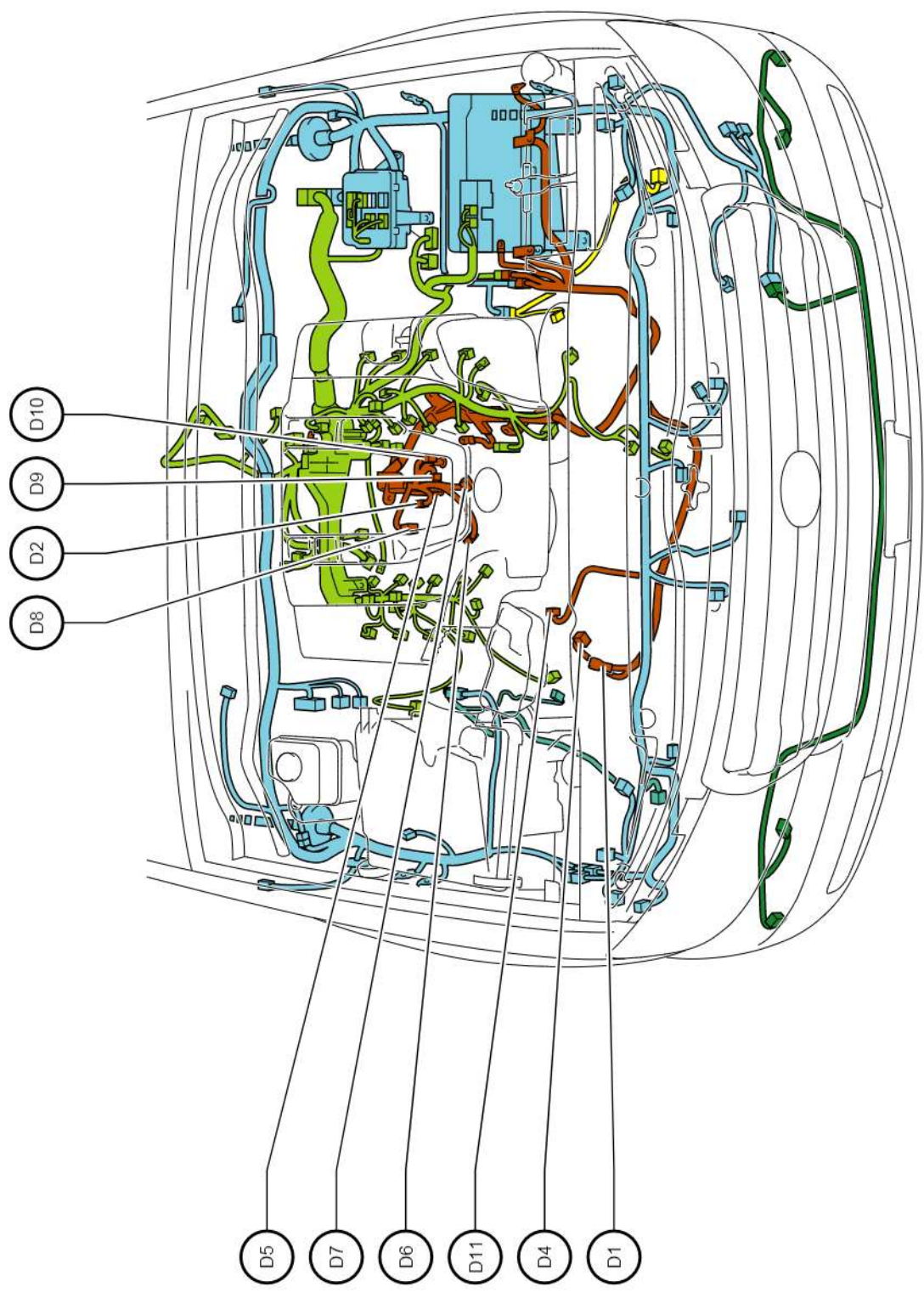

Position of Parts in Engine Compartment <RHD 2UZ-FE>

- D 1 Generator Assembly
- D 2 Starter Assembly
- D 4 Generator Assembly
- D 5 Starter Assembly
- D 6 Knock Control Sensor (Bank 2)
- D 7 Knock Control Sensor (Bank 1)
- D 8 Air Pump Assembly
- D 9 Air Pressure Sensor
- D 10 Air Switching Valve
- D 11 Engine Oil Level Sensor

Position of Parts in Engine Compartment <RHD 2UZ-FE>

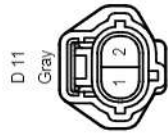
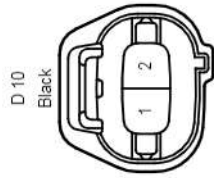
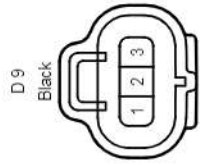
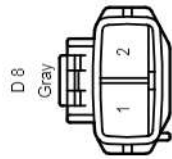
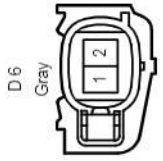
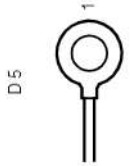
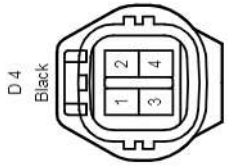
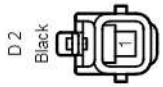

Position of Parts in Engine Compartment <RHD 2UZ-FE>

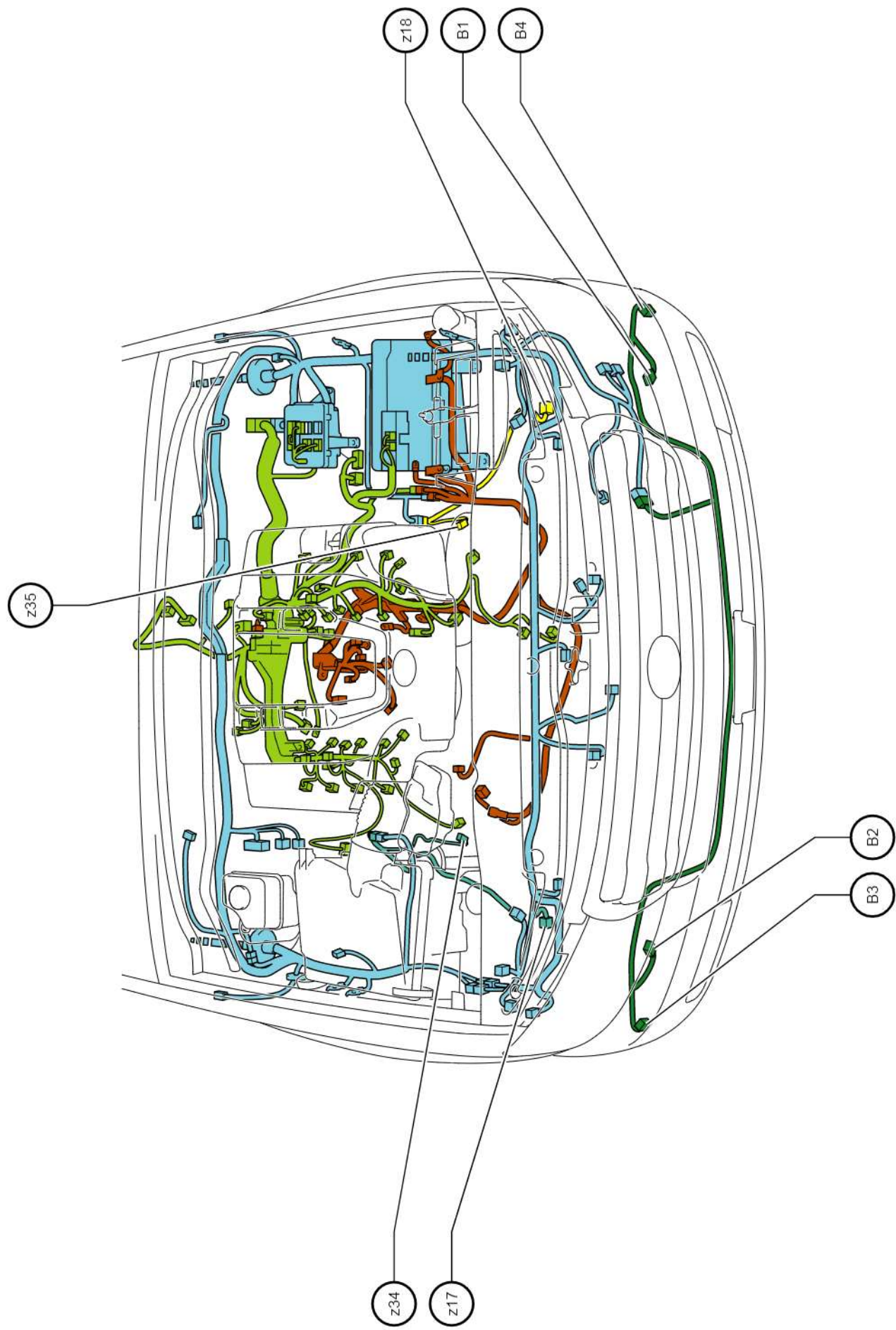

Position of Parts in Engine Compartment <RHD 2UZ-FE>

- B 1 Fog Light Assembly LH
- B 2 Fog Light Assembly RH
- B 3 No.1 Ultrasonic Sensor RH
- B 4 No.1 Ultrasonic Sensor LH

- Z 17 Front Speed Sensor RH
- Z 18 Front Speed Sensor LH
- Z 34 Front Height Control Sensor Sub-Assembly RH
- Z 35 Front Height Control Sensor Sub-Assembly LH

Position of Parts in Engine Compartment <RHD 2UZ-FE>

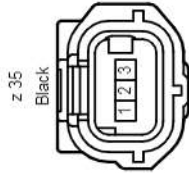
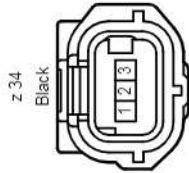
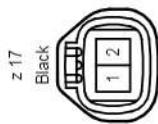
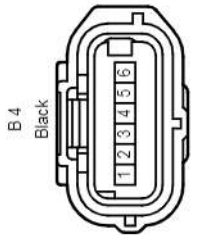
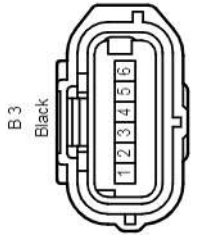
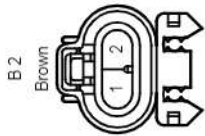
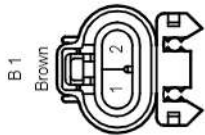

Wire and Wire in Engine Compartment <RHD 2UZ-FE>

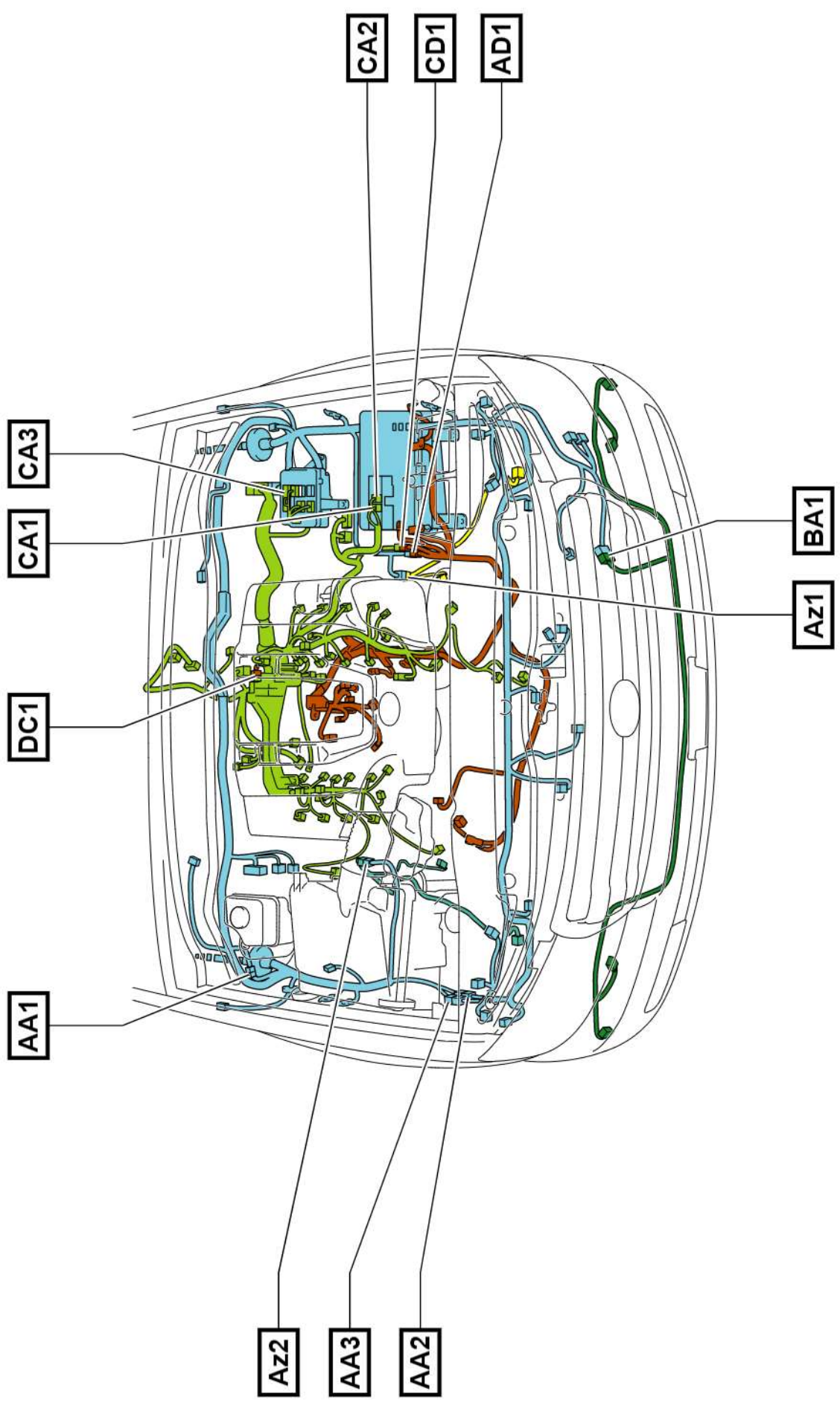

Wire and Wire in Engine Compartment <RHD 2UZ-FE>

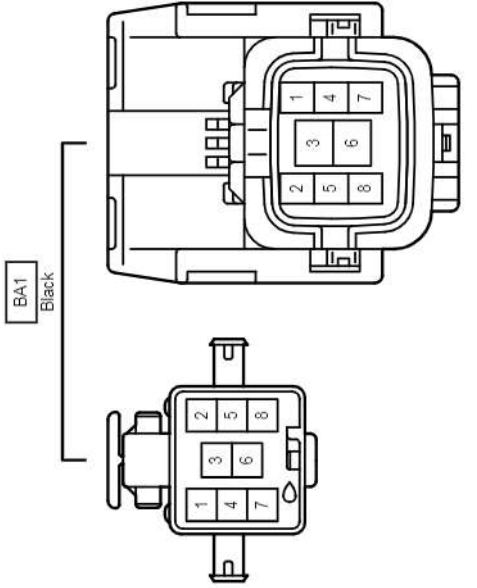
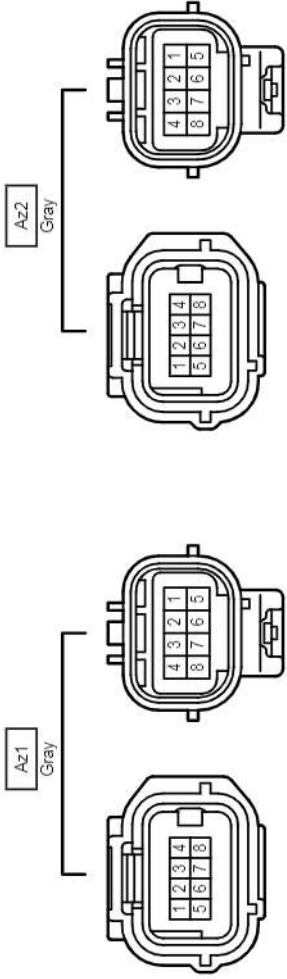
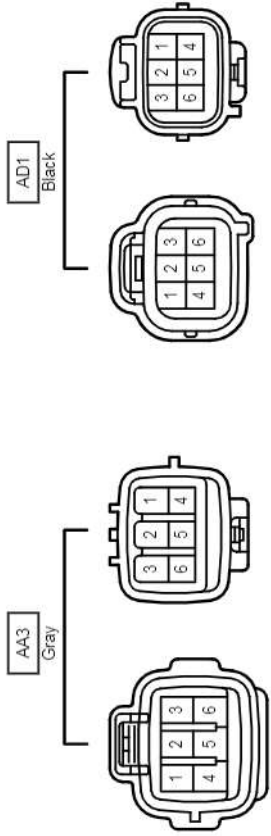
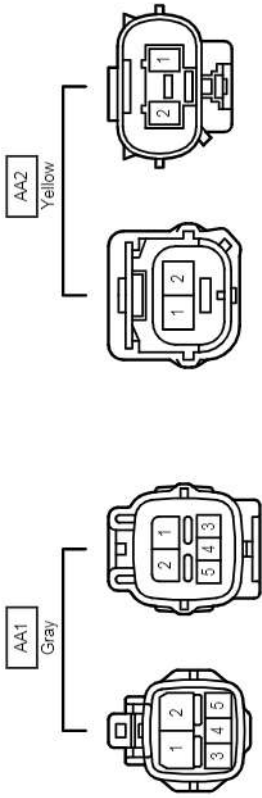

Wire and Wire in Engine Compartment <RHD 2UZ-FE>

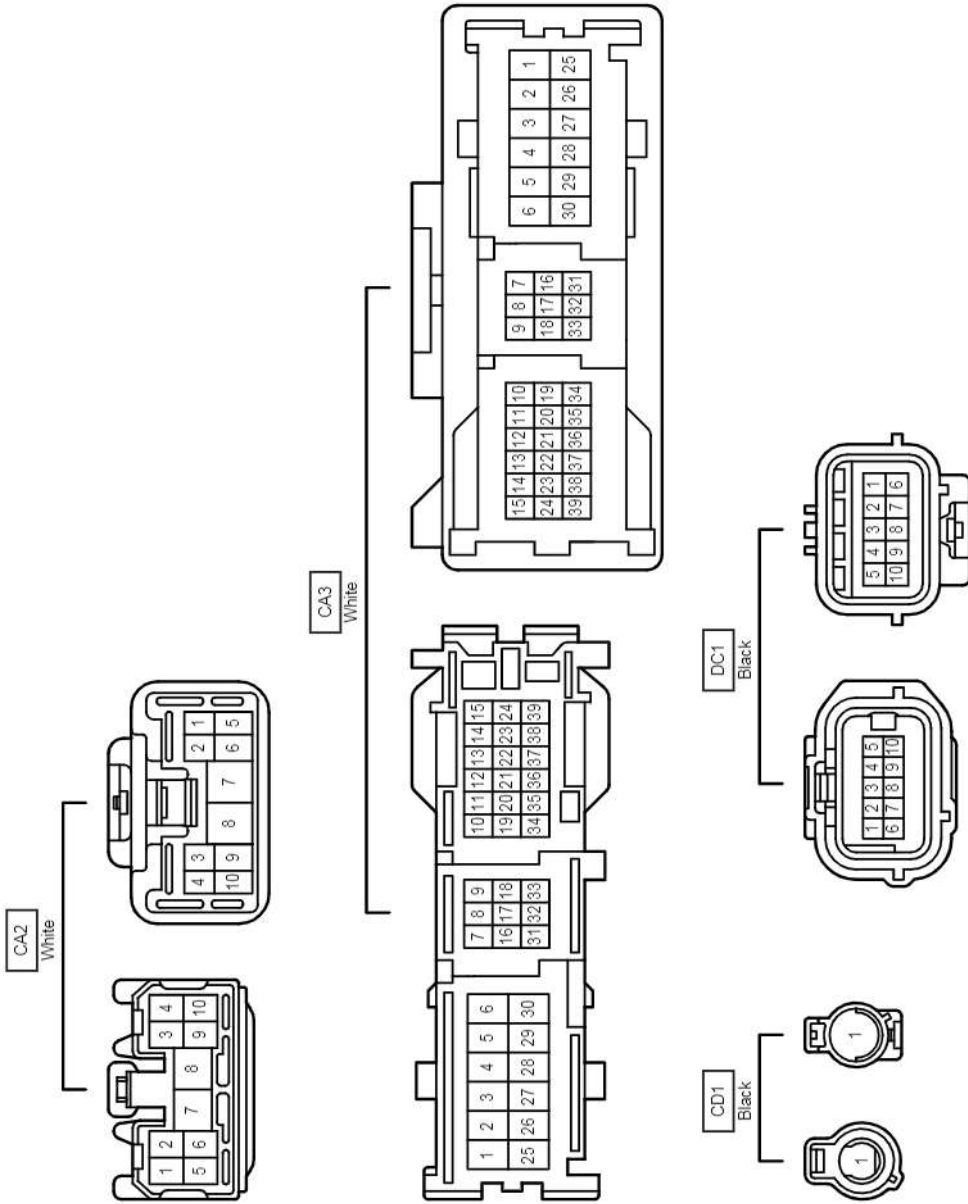

Ground Points in Engine Compartment <LHD 3UR-FE>

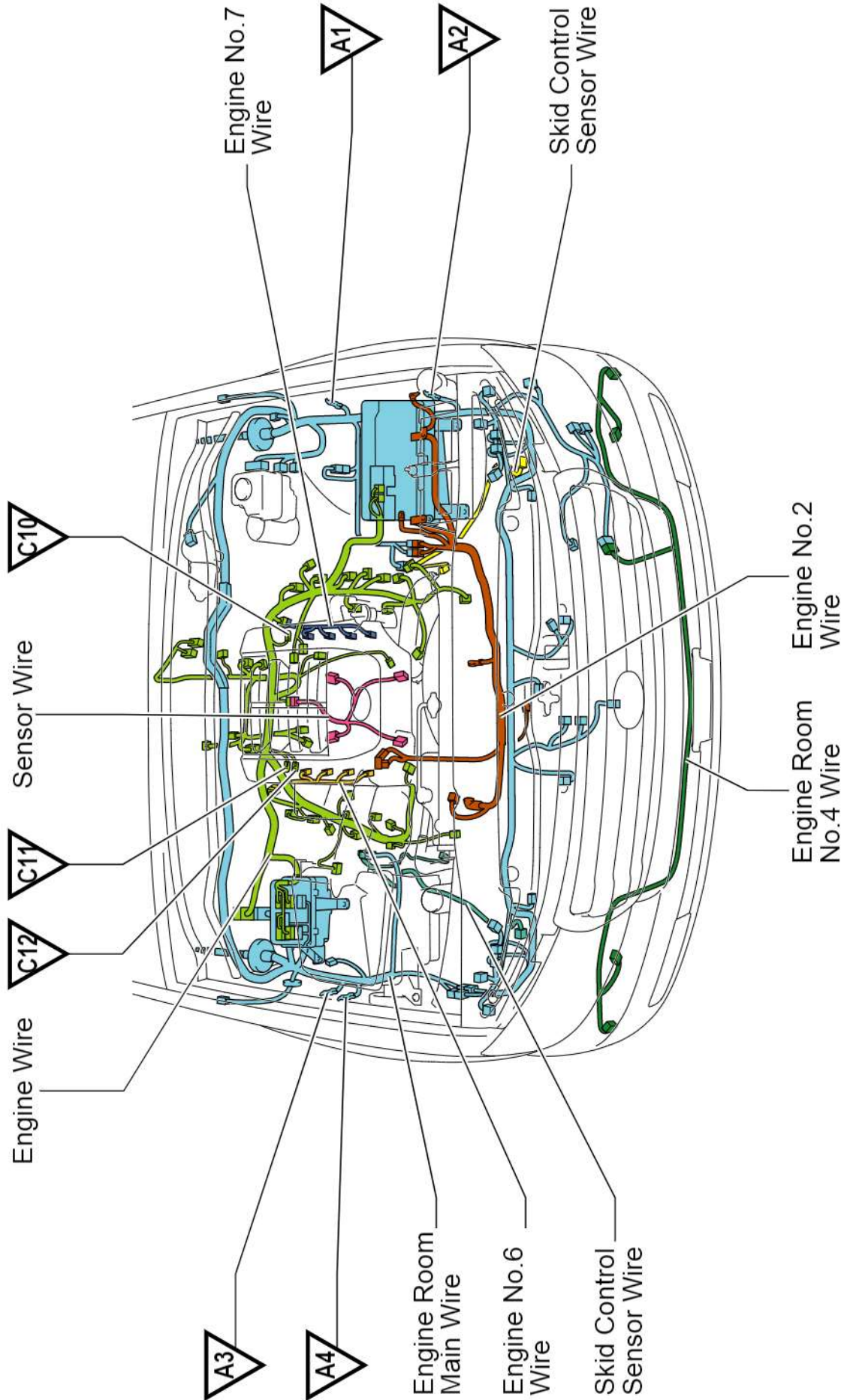

Position of Parts in Engine Compartment <LHD 3UR-FE>

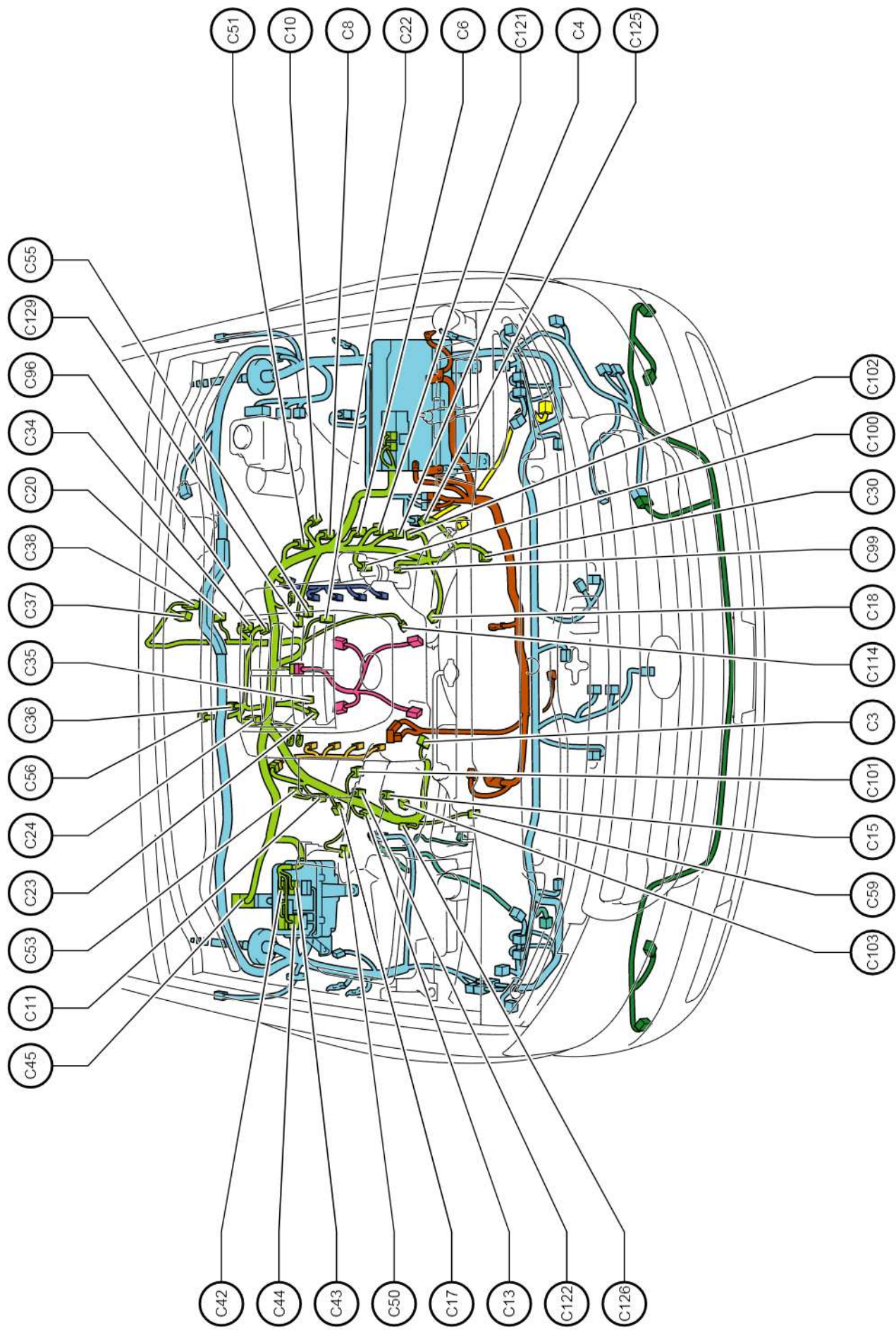

C 3	Throttle Body Assembly
C 4	Ignition Coil Assembly No.1
C 6	Ignition Coil Assembly No.3
C 8	Ignition Coil Assembly No.5
C 10	Noise Filter (Ignition Bank 1)
C 11	Ignition Coil Assembly No.6
C 13	Ignition Coil Assembly No.4
C 15	Ignition Coil Assembly No.2
C 17	Noise Filter (Ignition Bank 2)
C 18	E.F.I. Engine Coolant Temperature Sensor
C 20	Oxygen Sensor (Bank 1 Sensor 2)
C 22	Air Fuel Ratio Sensor (Bank 1 Sensor 1)
C 23	Air Fuel Ratio Sensor (Bank 2 Sensor 1)
C 24	Park/Neutral Position Switch
C 30	Cooler Compressor Assembly
C 34	Electronically Controlled Transmission Solenoid
C 35	Transmission Revolution Sensor (Turbine)
C 36	Transmission Revolution Sensor (Counter Gear)
C 37	Transfer Shift Actuator Assembly
C 38	Transfer Shift Actuator Assembly
C 42	Junction Connector
C 43	Junction Connector
C 44	Junction Connector
C 45	ECM
C 50	Mass Air Flow Meter
C 51	Ignition Coil Assembly No.7
C 53	Ignition Coil Assembly No.8
C 55	Purge VSV
C 56	Oxygen Sensor (Bank 2 Sensor 2)
C 59	Power Steering Oil Pressure Sensor
C 96	Electronically Controlled Transmission Solenoid
C 99	Camshaft Position Sensor
C 100	VT Sensor (Bank 1 Intake Side)
C 101	VT Sensor (Bank 2 Intake Side)
C 102	Camshaft Timing Oil Control Valve (Bank 1 Intake Side)
C 103	Camshaft Timing Oil Control Valve (Bank 2 Intake Side)
C 114	Crankshaft Position Sensor
C 121	VT Sensor (Bank 1 Exhaust Side)
C 122	VT Sensor (Bank 2 Exhaust Side)
C 125	Camshaft Timing Oil Control Valve (Bank 1 Exhaust Side)
C 126	Camshaft Timing Oil Control Valve (Bank 2 Exhaust Side)
C 129	VSV (ACIS)

Position of Parts in Engine Compartment <LHD 3UR-FE>

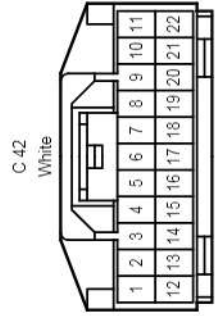
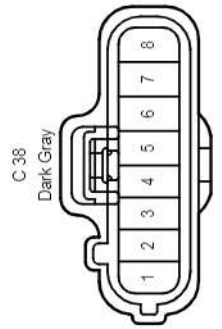
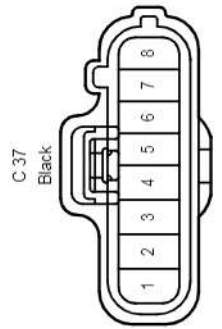
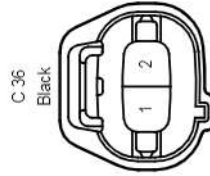
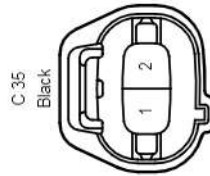
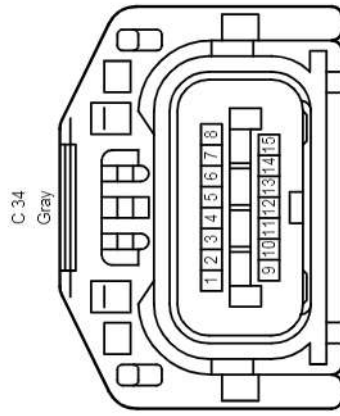
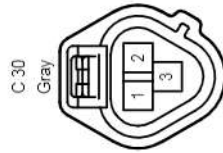
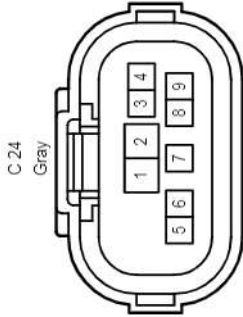
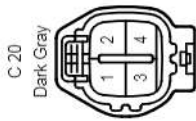
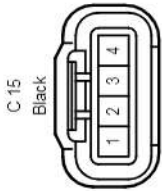
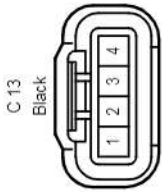
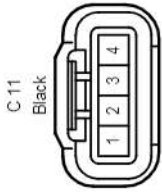
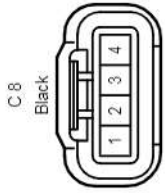
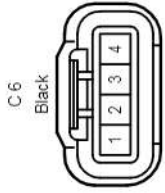
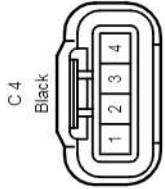
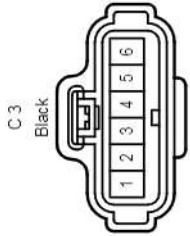

C 43
White

C 44
Blue

Position of Parts in Engine Compartment <LHD 3UR-FE>

C 45
Black

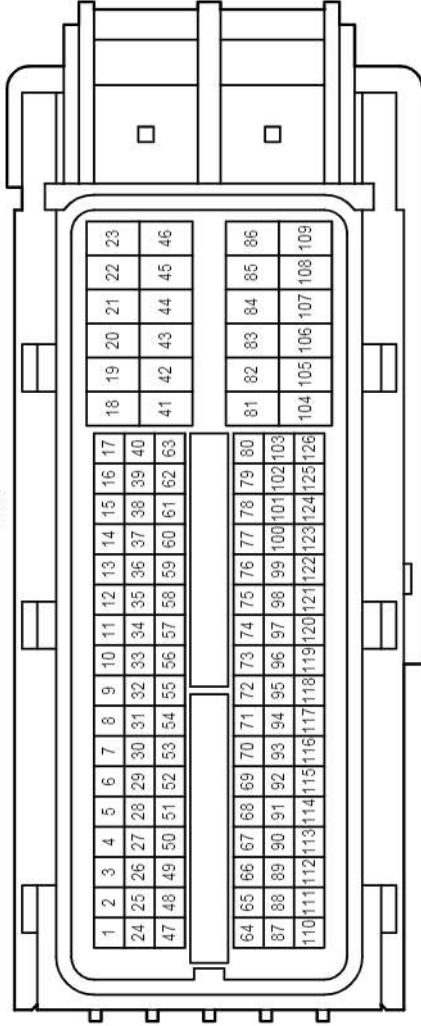

C 50
Black

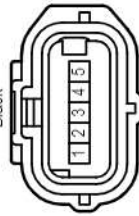

C 51
Black

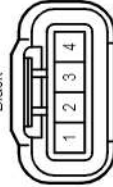

C 53
Black

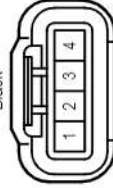

C 55
Black



C 56
Dark Gray



C 59
Gray

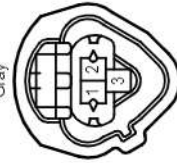

C 96
Gray

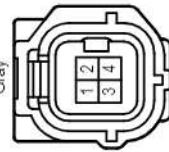

C 99
Black

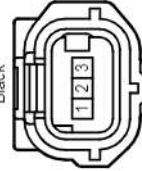

C 100
Black



C 101
Black



C 102
Black



C 103
Black



C 114
Black



C 121
Black

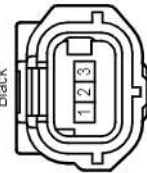

C 122
Black

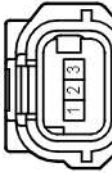

C 125
Black



C 126
Black



C 129
Black

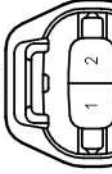

Position of Parts in Engine Compartment <LHD 3UR-FE>

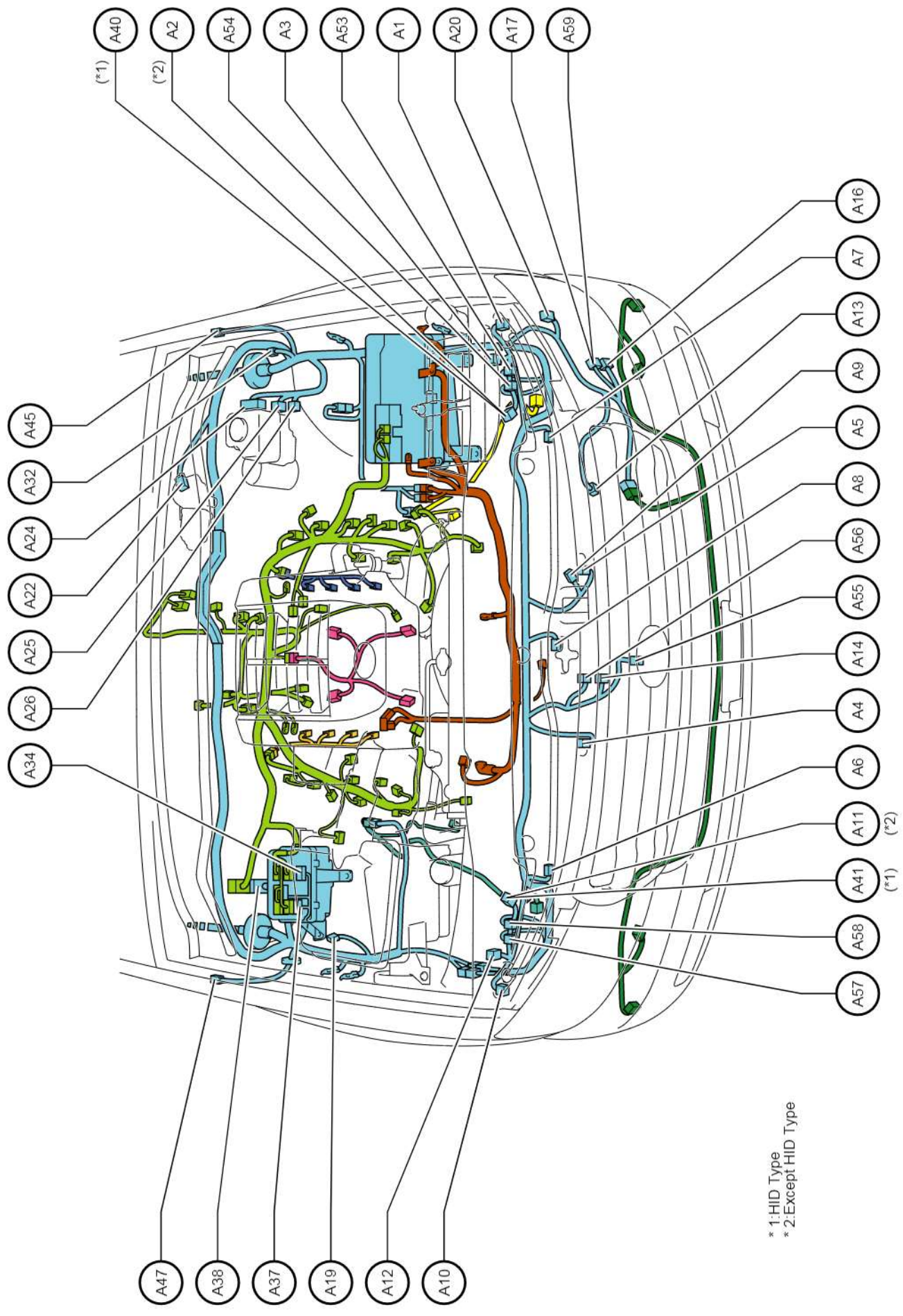

* 1:HID Type
* 2:Except HID Type

A	1	Headlight Assembly LH
A	2	Headlight Assembly LH
A	3	Headlight Assembly LH
A	4	High Pitched Horn Assembly
A	5	Low Pitched Horn Assembly
A	6	Front Airbag Sensor RH
A	7	Front Airbag Sensor LH
A	8	Engine Hood Courtesy Switch
A	8	Engine Hood Courtesy Switch
A	9	Condenser Blower Motor Assembly
A	10	Headlight Assembly RH
A	11	Headlight Assembly RH
A	12	Headlight Assembly RH
A	13	A/C Pressure Sensor
A	14	Ambient Temperature Sensor
A	16	Windshield Washer Motor and Pump Assembly
A	17	Headlight Cleaner Control Relay and Motor
A	19	Security Horn Assembly
A	20	Wireless Door Lock Buzzer
A	22	Windshield Wiper Motor Assembly
A	24	Skid Control ECU with Actuator Assembly
A	25	Skid Control ECU with Actuator Assembly
A	26	Brake Fluid Level Warning Switch (Brake Master Cylinder Reservoir Assembly)
A	32	Noise Filter
A	34	Junction Connector
A	37	Junction Connector
A	38	ECM
A	40	Headlight Assembly LH
A	41	Headlight Assembly RH
A	45	Side Turn Signal Light Assembly LH
A	47	Side Turn Signal Light Assembly RH
A	53	Headlight Assembly LH
A	54	Headlight Assembly LH
A	55	Front Television Camera Assembly
A	56	Millimeter Wave Radar Sensor Assembly
A	57	Headlight Assembly RH
A	58	Headlight Assembly RH
A	59	Headlight Cleaner Control Relay and Motor

Position of Parts in Engine Compartment <LHD 3UR-FE>

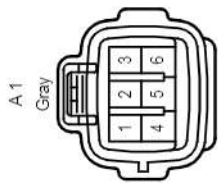

A 1
Gray

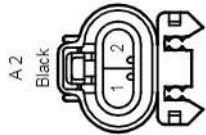

A 2
Black

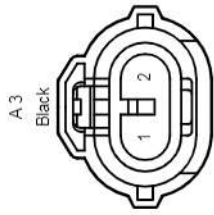

A 3
Black

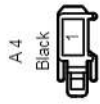

A 4
Black



A 5
Black

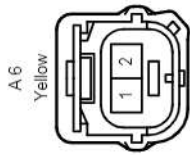

A 6
Yellow

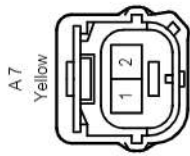

A 7
Yellow

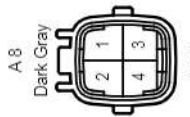

A 8
Dark Gray



A 9
Black

(Except U.K.)

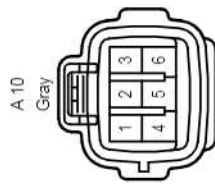

A 10
Gray

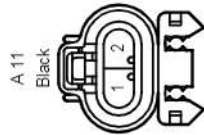

A 11
Black

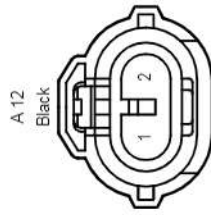

A 12
Black

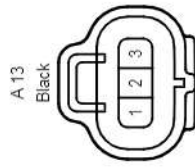

A 13
Black



A 14
Black

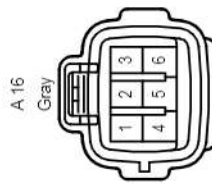

A 16
Gray

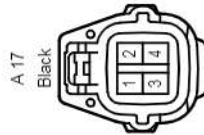

A 17
Black

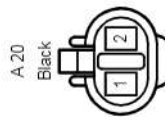

A 20
Black

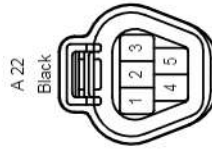

A 22
Black

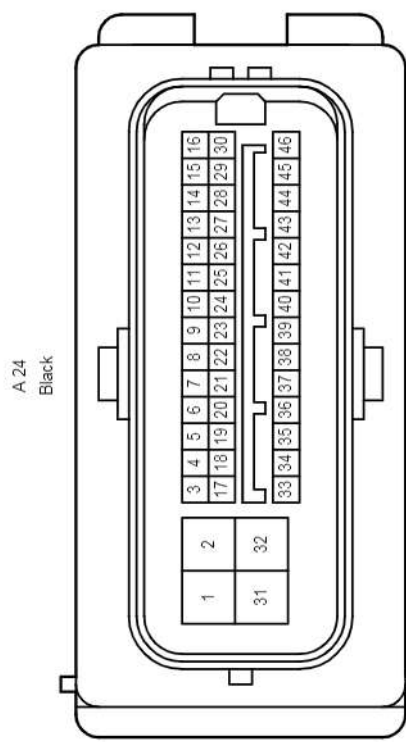

A 24
Black

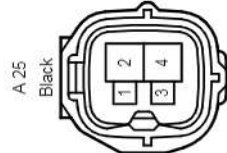

A 25
Black

Position of Parts in Engine Compartment <LHD 3UR-FE>

A 37
Blue

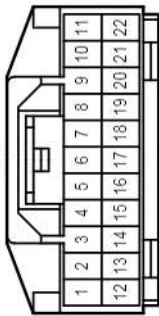

A 38
Black

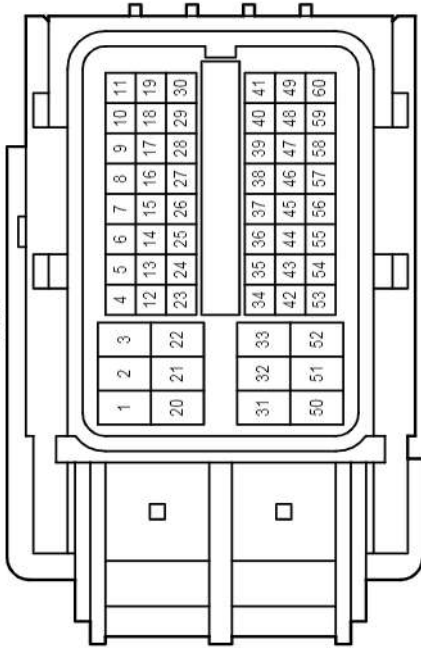

A 40
Gray



A 41
Gray



A 45
Gray



A 47
Gray



A 53
Black



A 54
Black

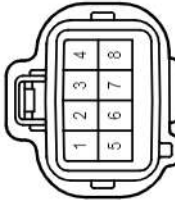

A 55
Black

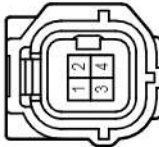

A 56
Black

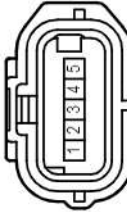

A 57
Black



A 58
Black



A 59
White



Position of Parts in Engine Compartment <LHD 3UR-FE>

* 3: Before Jan. 2012 Production
* 4: From Jan. 2012 Production

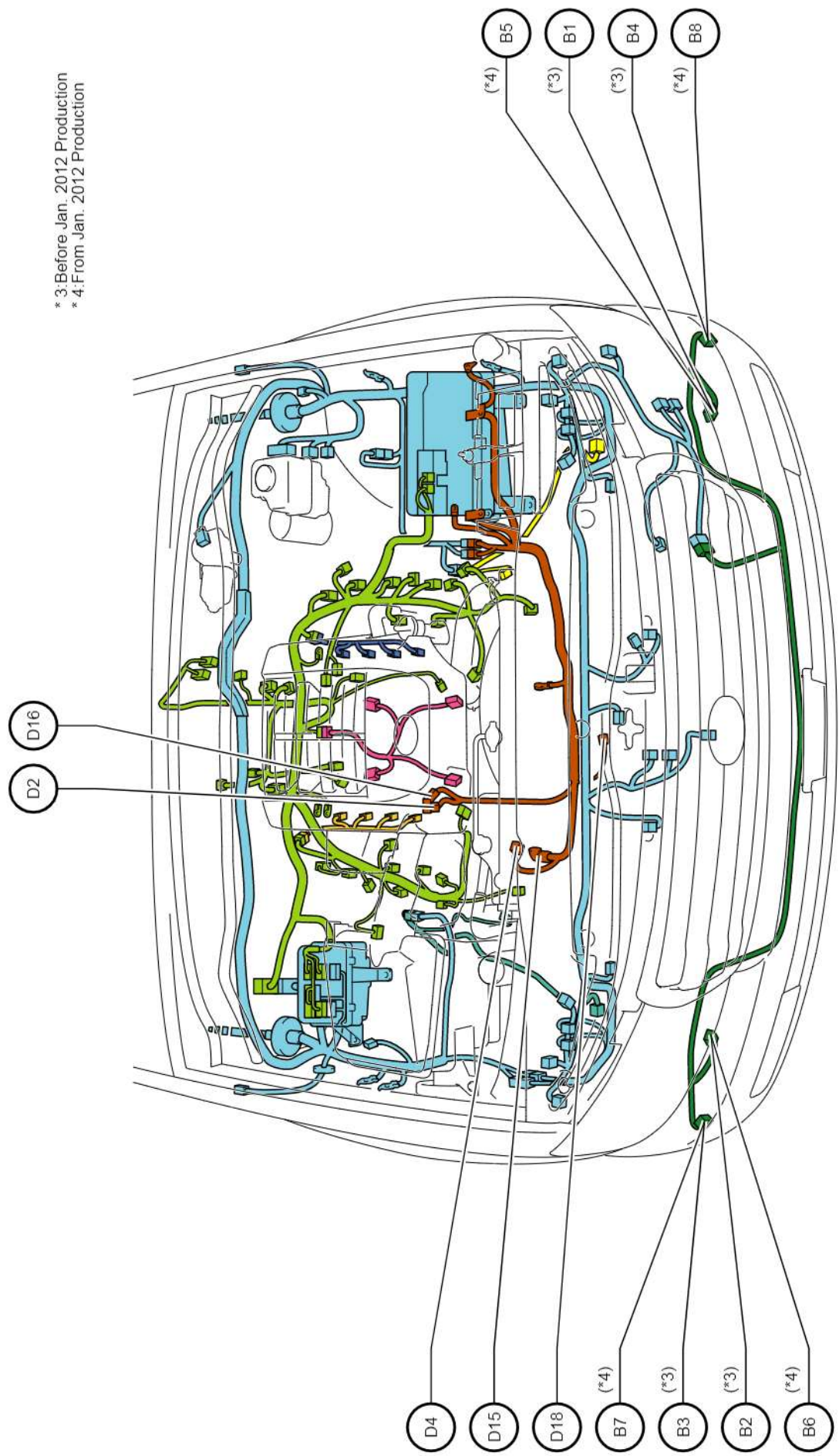

- B 1 Fog Light Assembly LH
- B 2 Fog Light Assembly RH
- B 3 No.1 Ultrasonic Sensor RH
- B 4 No.1 Ultrasonic Sensor LH
- B 5 Fog Light Assembly LH
- B 6 Fog Light Assembly RH
- B 7 No.1 Ultrasonic Sensor RH
- B 8 No.1 Ultrasonic Sensor LH

- D 2 Starter Assembly
- D 4 Generator Assembly
- D 15 Generator Assembly
- D 16 Starter Assembly
- D 18 Oil Pressure Sender Gage Assembly

Position of Parts in Engine Compartment <LHD 3UR-FE>

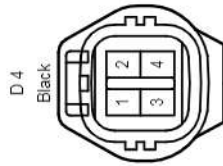
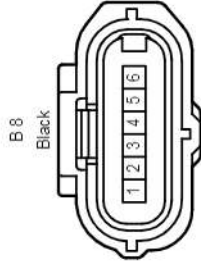
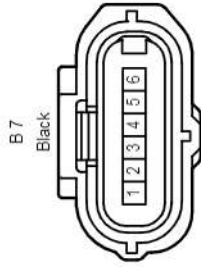
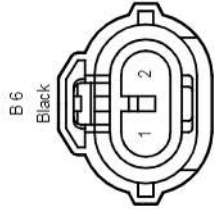
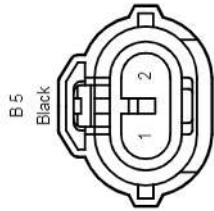
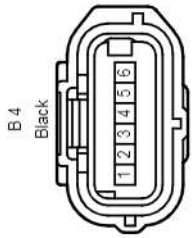
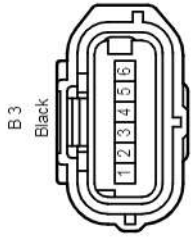
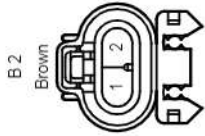
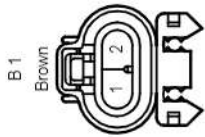

Position of Parts in Engine Compartment <LHD 3UR-FE>

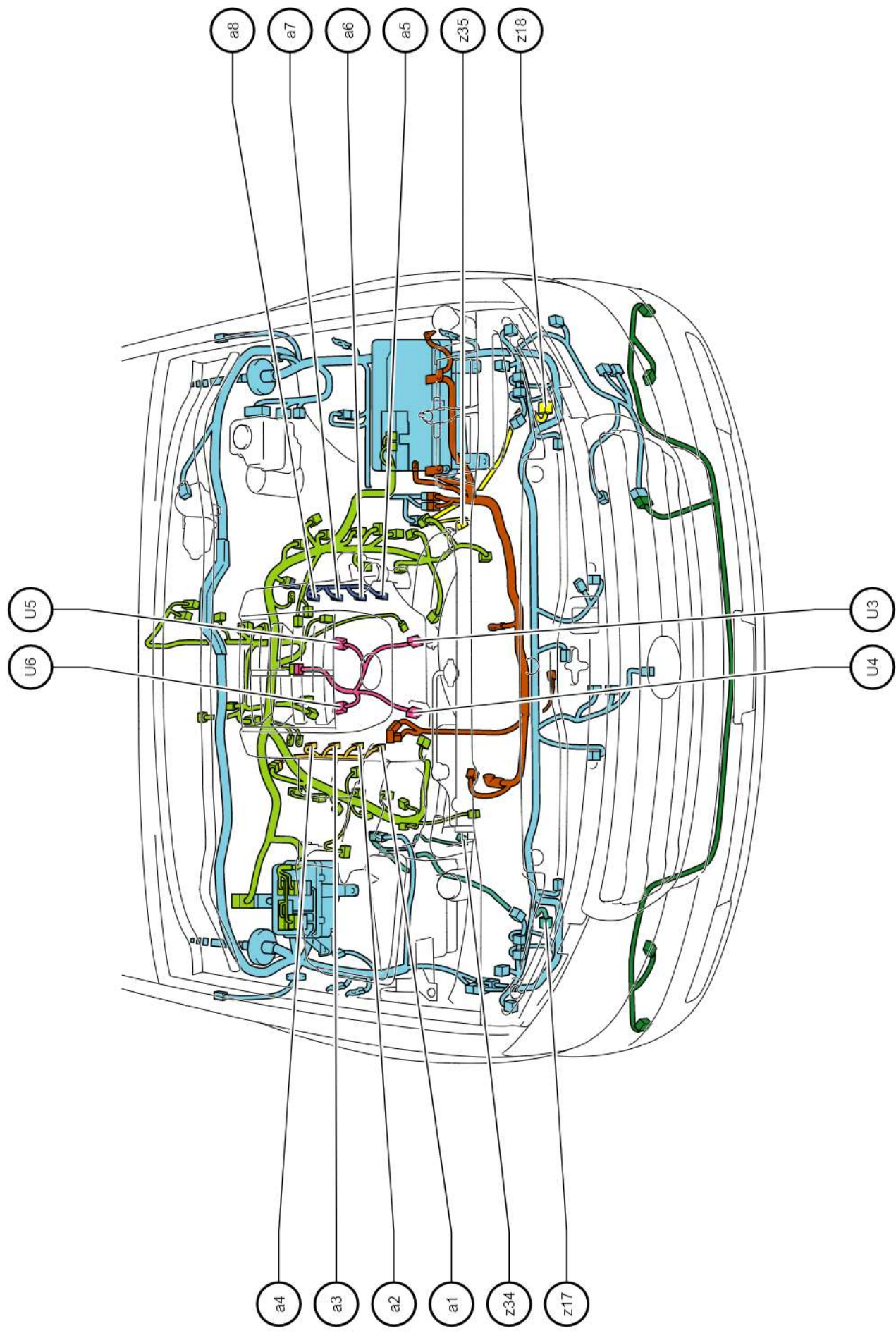

- U 3 Knock Control Sensor (Bank 1 Sensor 1)
- U 4 Knock Control Sensor (Bank 2 Sensor 1)
- U 5 Knock Control Sensor (Bank 1 Sensor 2)
- U 6 Knock Control Sensor (Bank 2 Sensor 2)

- a 1 Fuel Injector Assembly No.2
- a 2 Fuel Injector Assembly No.4
- a 3 Fuel Injector Assembly No.6
- a 4 Fuel Injector Assembly No.8
- a 5 Fuel Injector Assembly No.1
- a 6 Fuel Injector Assembly No.3
- a 7 Fuel Injector Assembly No.5
- a 8 Fuel Injector Assembly No.7

- z 17 Front Speed Sensor RH
- z 18 Front Speed Sensor LH
- z 34 Front Height Control Sensor Sub-Assembly RH
- z 35 Front Height Control Sensor Sub-Assembly LH

Position of Parts in Engine Compartment <LHD 3UR-FE>

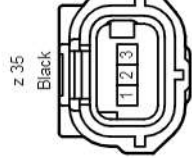
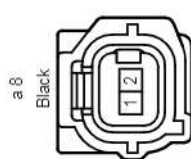
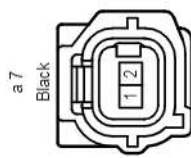
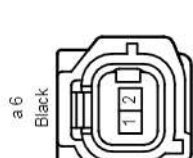
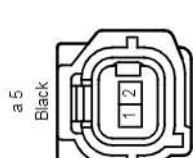
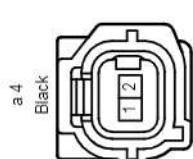
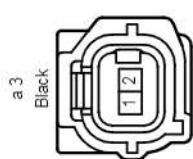
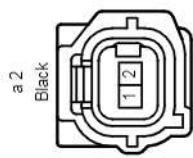
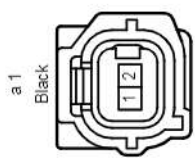
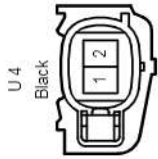
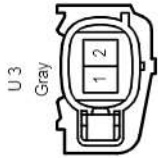

Wire and Wire in Engine Compartment <LHD 3UR-FE>

- * 1:Liftgate Type Body
- * 2:Swing Type Body

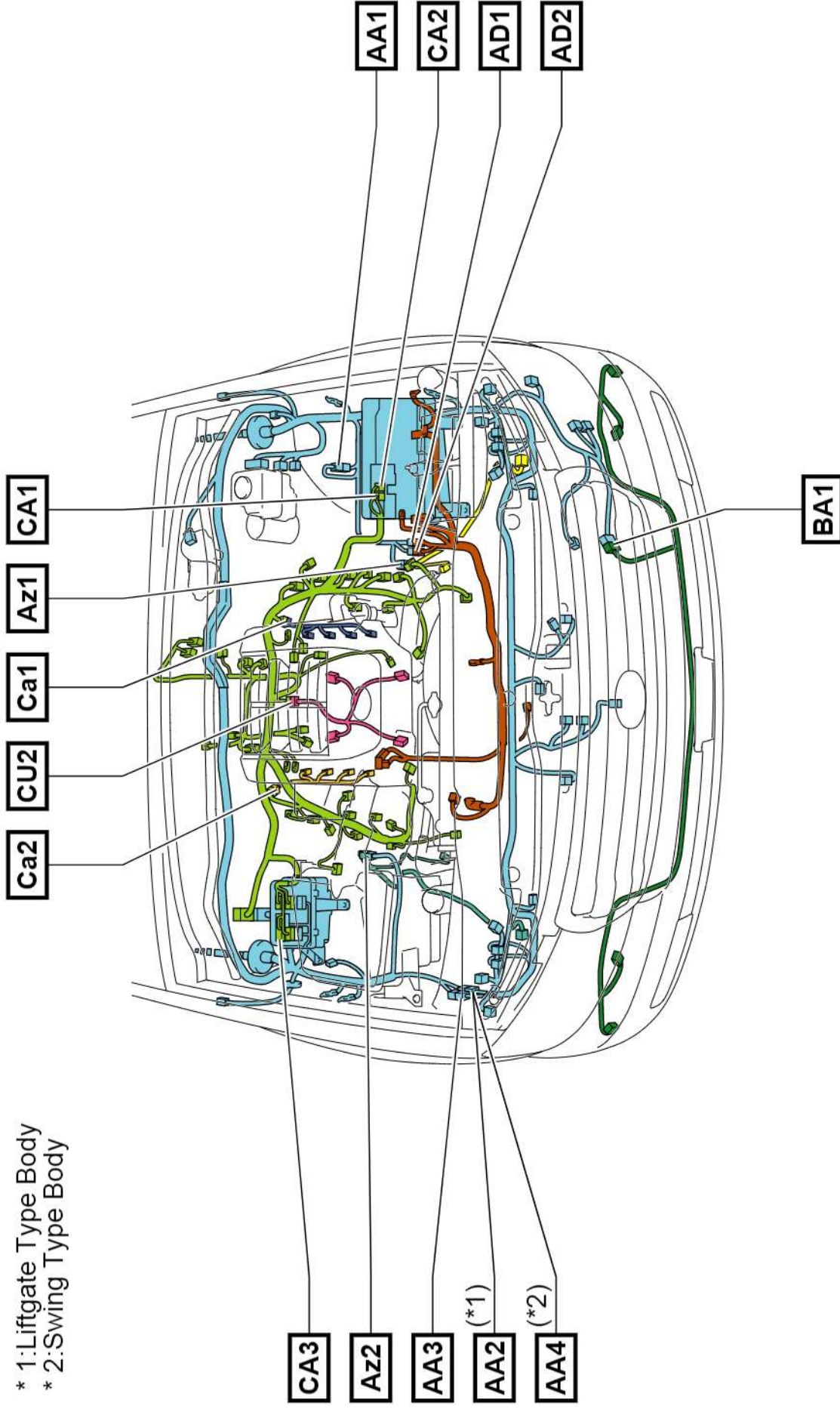

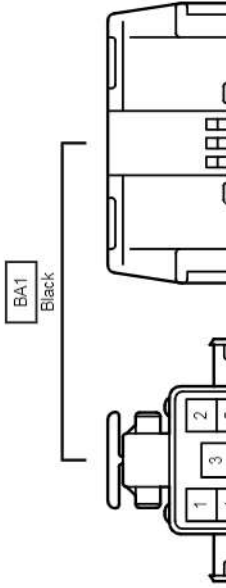
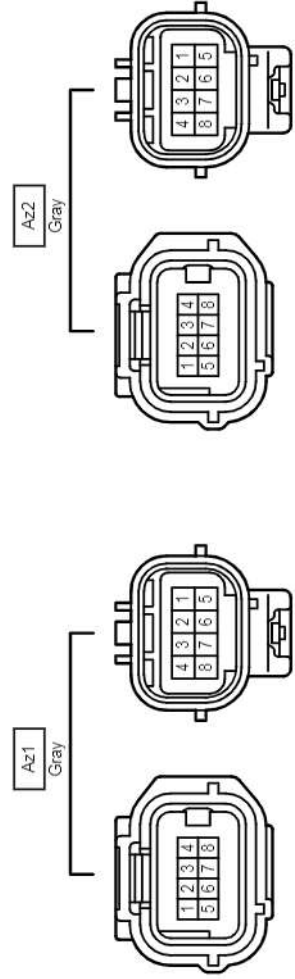
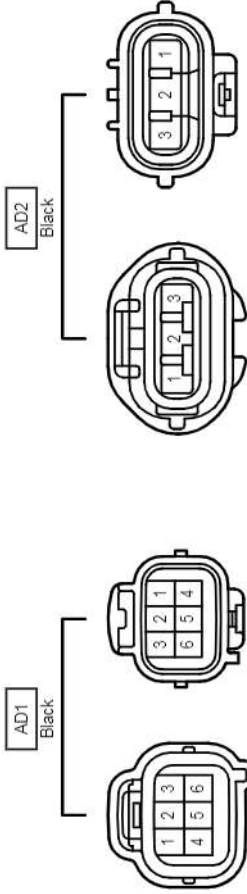
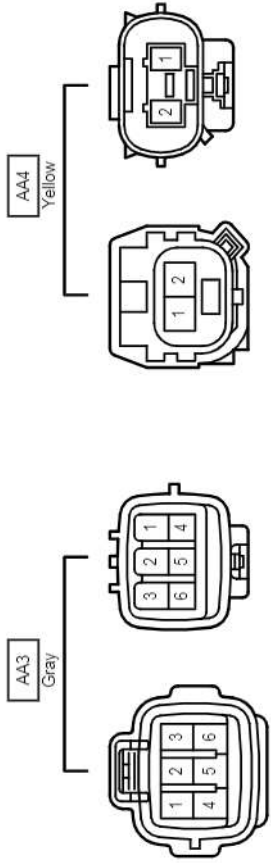
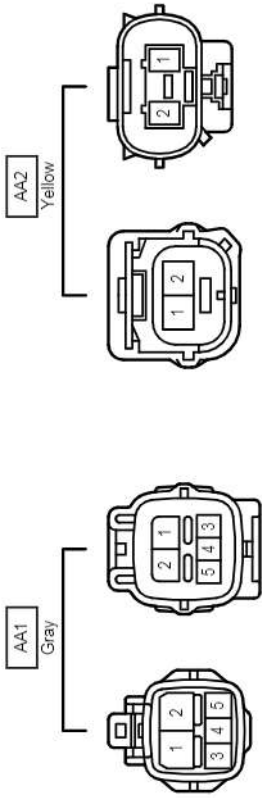

Wire and Wire in Engine Compartment <LHD 3UR-FE>

CA1
White

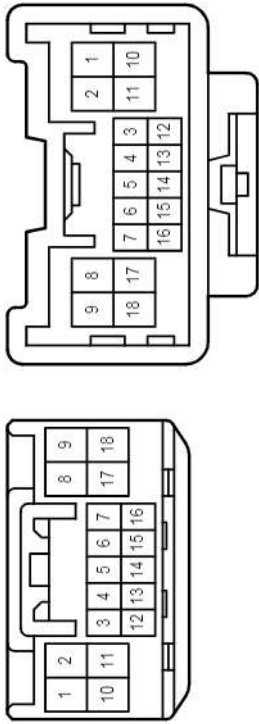

CA2
White

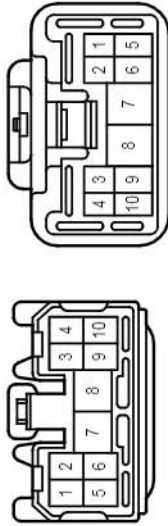

CA3
White

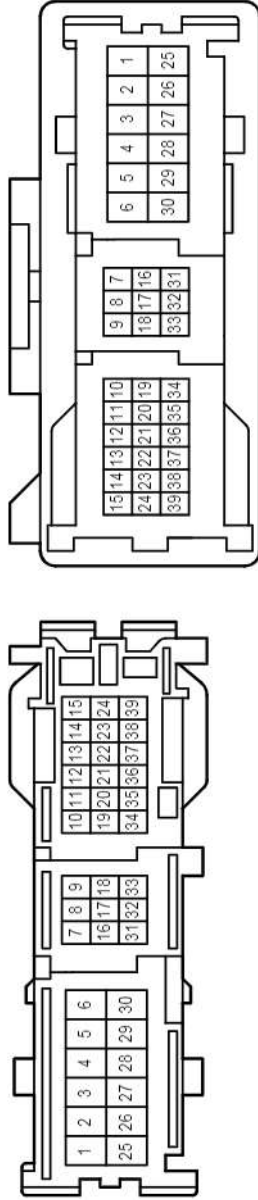

CU2
Gray

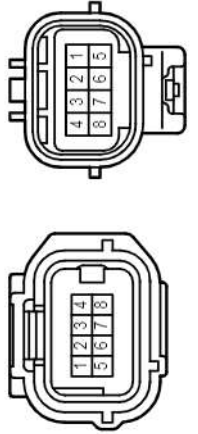

CA1
Gray

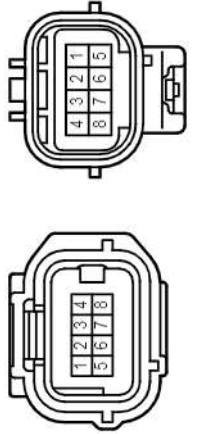

Position of Parts in Seat <LHD Front Separate Seat Type>

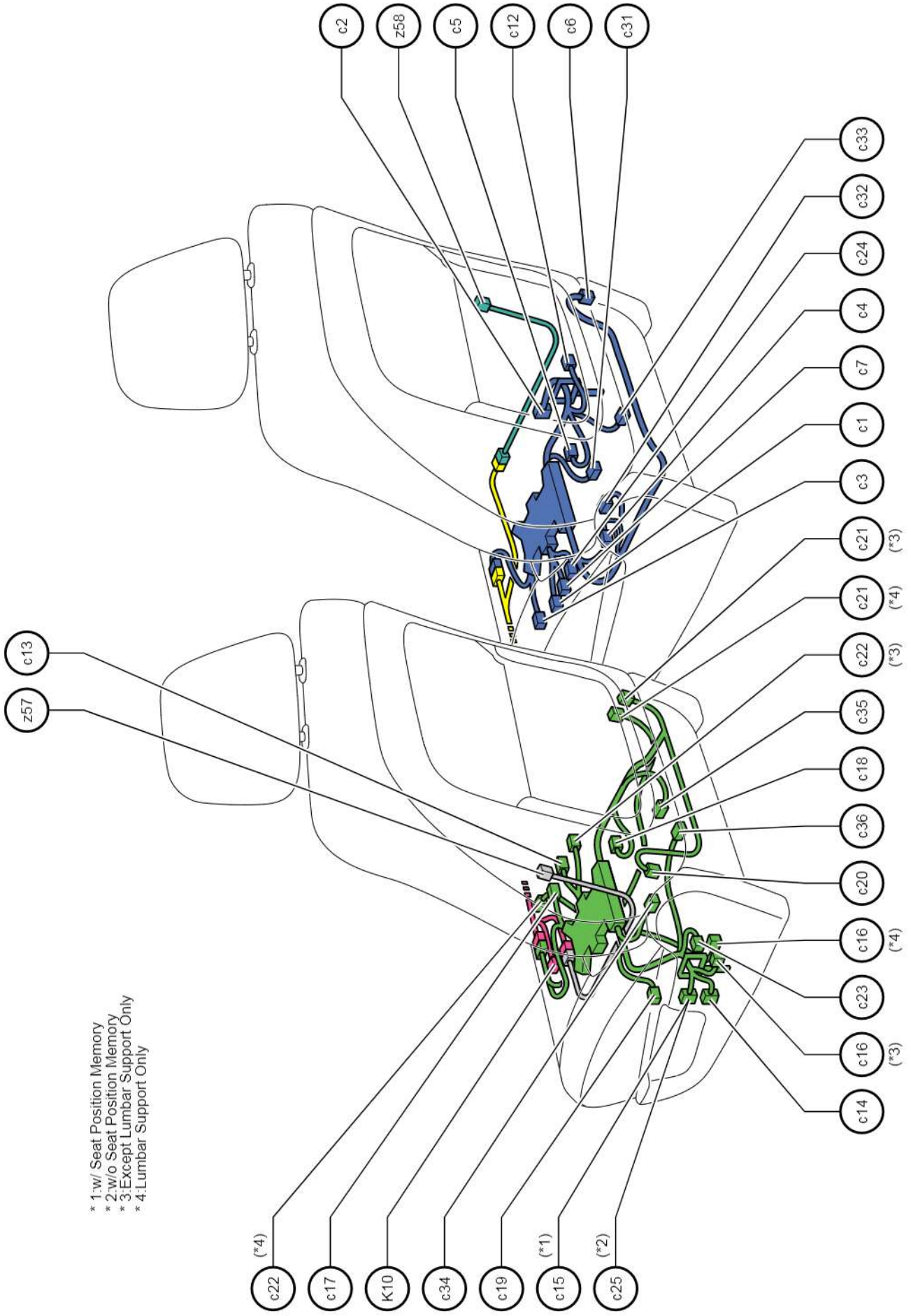

- * 1: w/ Seat Position Memory
- * 2: w/o Seat Position Memory
- * 3: Except Lumbar Support Only
- * 4: Lumbar Support Only

K	10	Front Seat Inner Belt Assembly LH
c	1	Front Seat Heater Assembly RH
c	2	Front Power Seat Switch Assembly RH
c	3	Front Power Seat Slide Position Motor Assembly RH
c	4	Front Power Seat Lift Position Motor Assembly RH
c	5	Front Power Seat Vertical Position Motor Assembly RH
c	6	Front Power Seat Reclining Position Motor Assembly RH
c	7	Front Seat Inner Belt Assembly RH
c	12	Junction Connector
c	13	Front Seat Heater Assembly LH
c	14	Front Position Control ECU and Switch Assembly LH
c	15	Front Position Control ECU and Switch Assembly LH
c	16	Front Power Seat Switch Assembly LH
c	17	Front Power Seat Slide Position Motor Assembly LH
c	18	Front Power Seat Lift Position Motor Assembly LH
c	19	Front Power Seat Vertical Position Motor Assembly LH
c	20	Front Power Seat Reclining Position Motor Assembly LH
c	21	Front Lumbar Support Forward and Back Motor Assembly LH
c	22	Front Seat Inner Belt Assembly LH
c	23	Junction Connector
c	24	Front Seat Inner Belt Assembly RH
c	25	Front Power Seat Switch Assembly LH
c	31	Seat Climate Control Blower RH
c	32	Seat Climate Control ECU RH
c	33	Front Seat Cushion Heater Assembly RH
c	34	Seat Climate Control Blower LH
c	35	Seat Climate Control ECU LH
c	36	Front Seat Cushion Heater Assembly LH
z	57	Front Side Airbag Squib Circuit LH
z	58	Front Side Airbag Squib Circuit RH

Position of Parts in Seat <LHD Front Separate Seat Type>

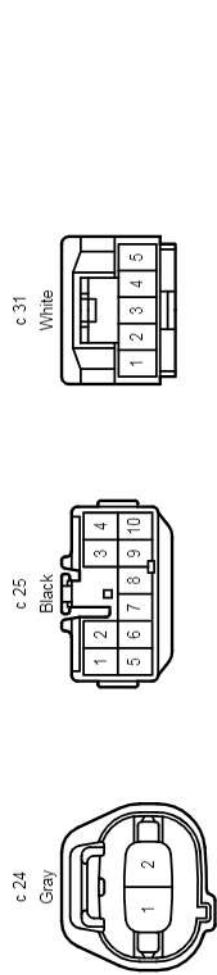
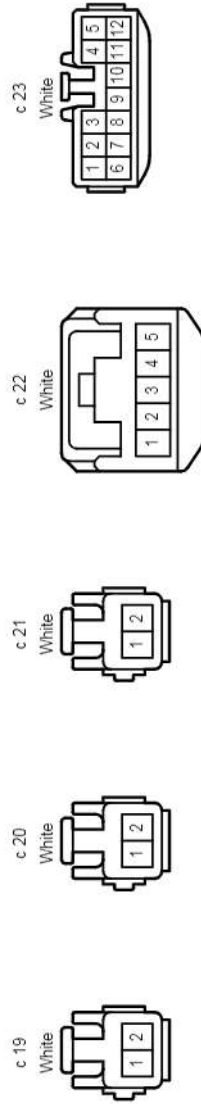
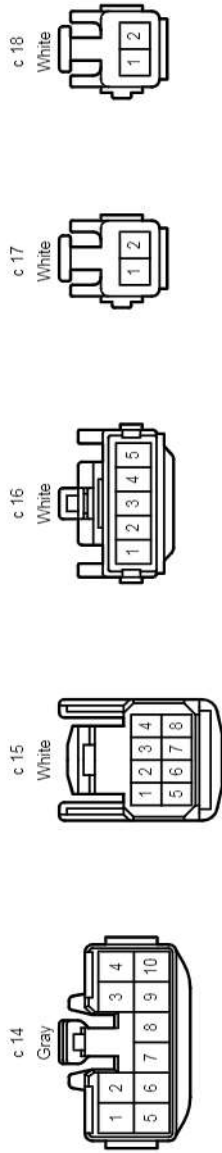
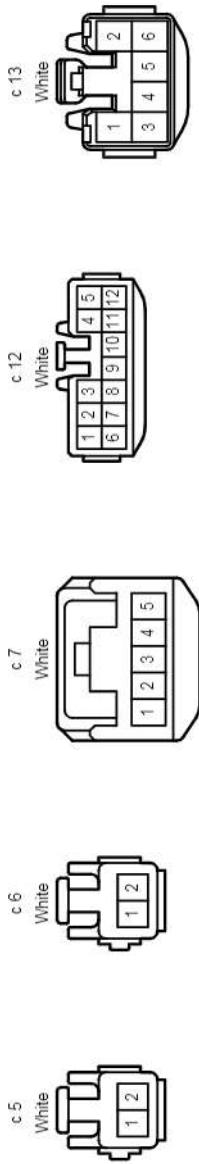
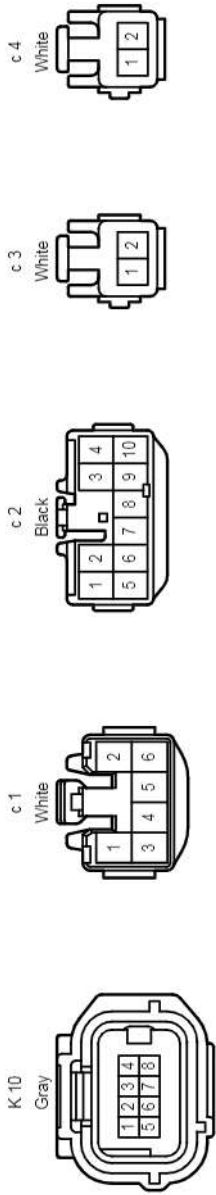

Wire and Wire in Seat <LHD Front Separate Seat Type>

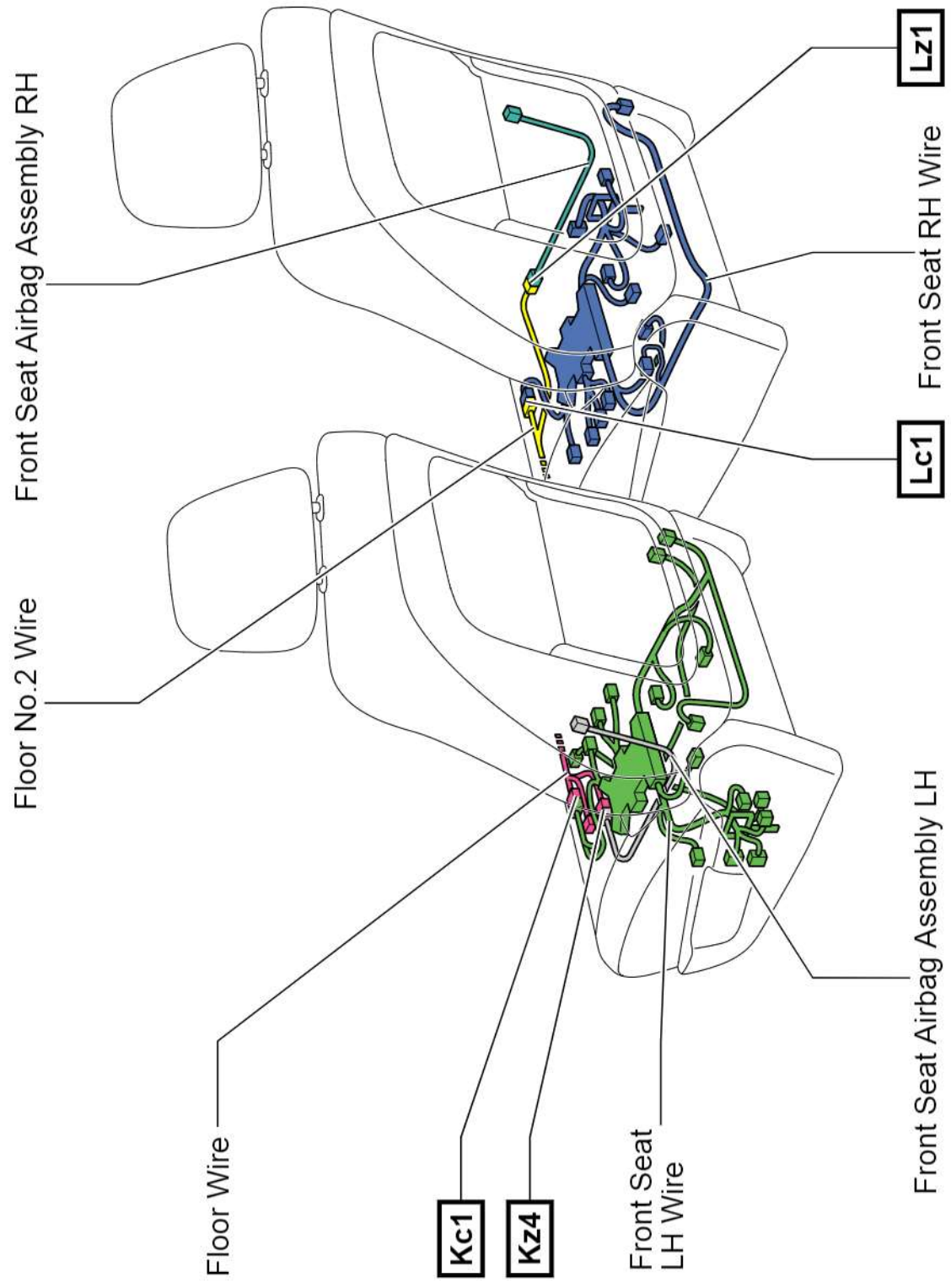

Wire and Wire in Seat <LHD Front Separate Seat Type>

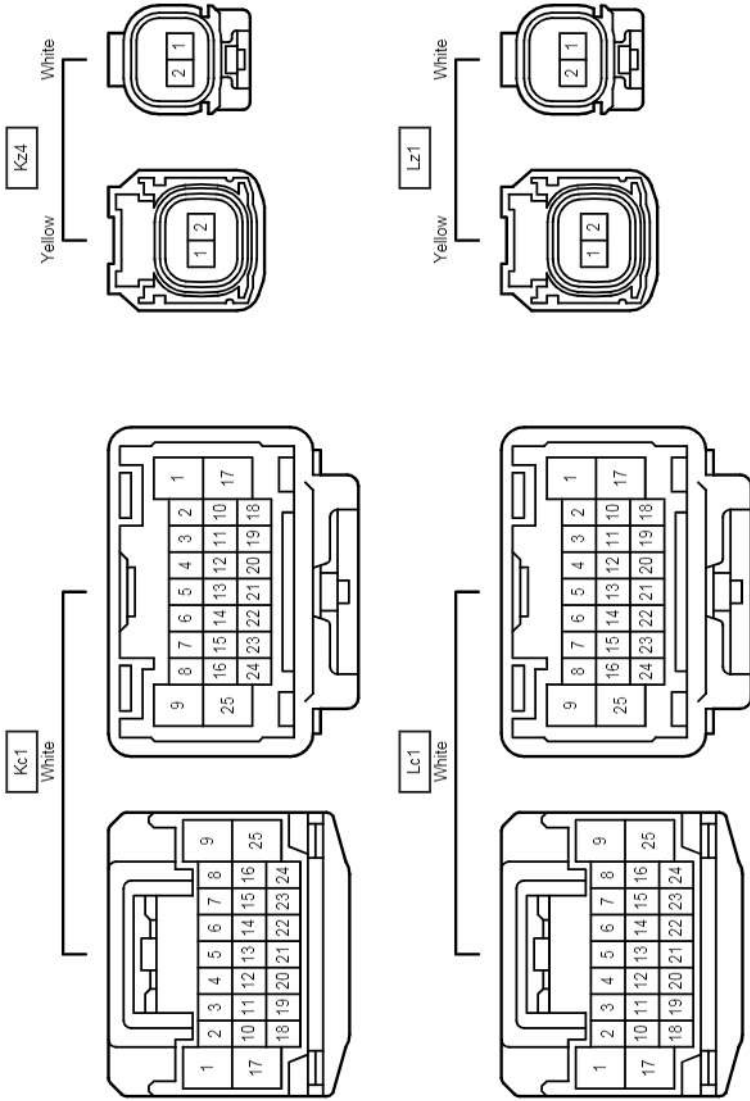

Position of Parts in Seat <RHD Front Separate Seat Type>

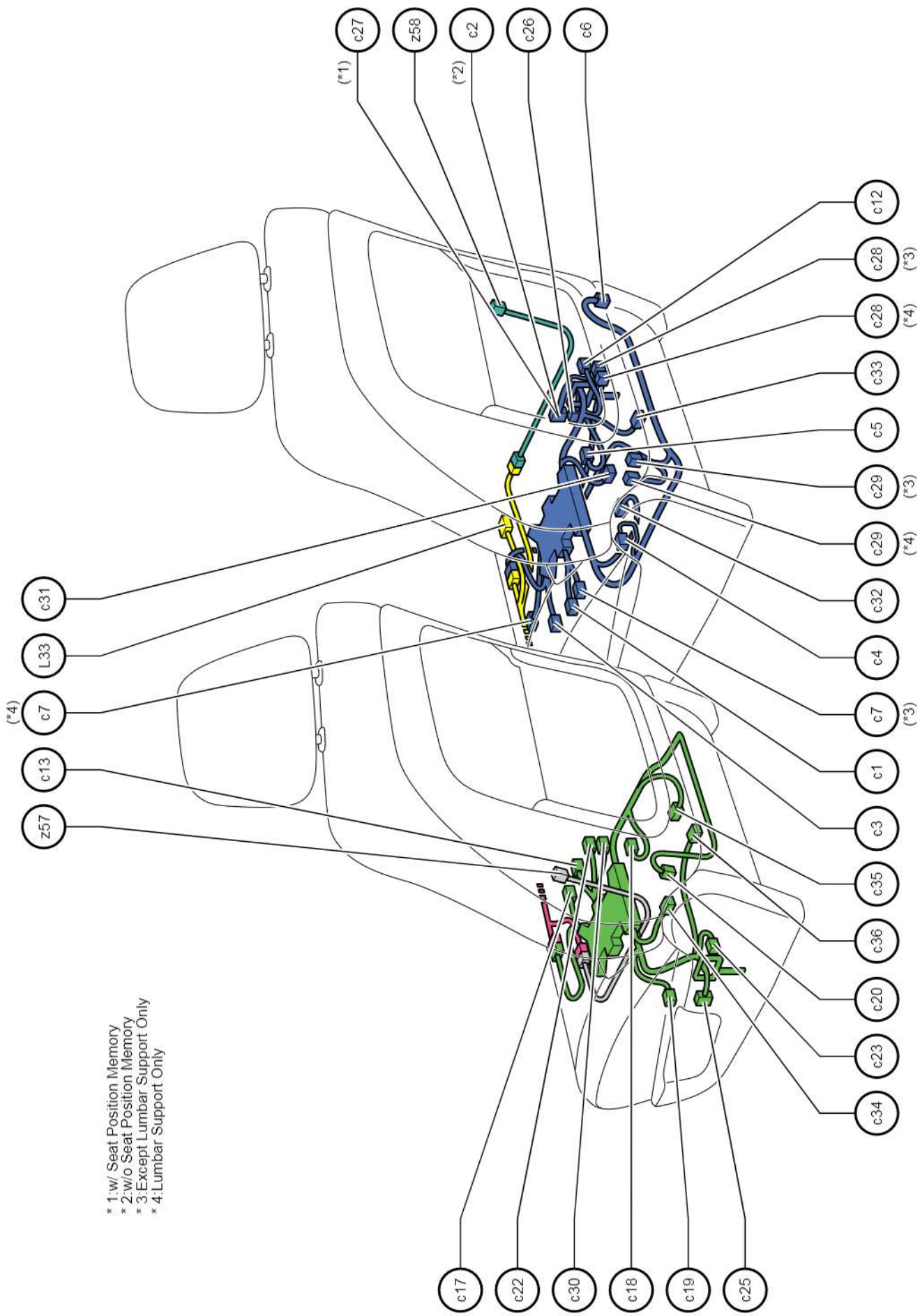

- * 1: w/ Seat Position Memory
- * 2: w/o Seat Position Memory
- * 3: Except Lumbar Support Only
- * 4: Lumbar Support Only

- L 33 Front Seat Inner Belt Assembly RH
- c 1 Front Seat Heater Assembly RH
- c 2 Front Power Seat Switch Assembly RH
- c 3 Front Power Seat Slide Position Motor Assembly RH
- c 4 Front Power Seat Lift Position Motor Assembly RH
- c 5 Front Power Seat Vertical Position Motor Assembly RH
- c 6 Front Power Seat Reclining Position Motor Assembly RH
- c 7 Front Seat Inner Belt Assembly RH
- c 12 Junction Connector
- c 13 Front Seat Heater Assembly LH
- c 17 Front Power Seat Slide Position Motor Assembly LH
- c 18 Front Power Seat Lift Position Motor Assembly LH
- c 19 Front Power Seat Vertical Position Motor Assembly LH
- c 20 Front Power Seat Reclining Position Motor Assembly LH
- c 22 Front Seat Inner Belt Assembly LH
- c 23 Junction Connector
- c 25 Front Power Seat Switch Assembly LH
- c 26 Front Position Control ECU and Switch Assembly RH
- c 27 Front Position Control ECU and Switch Assembly RH
- c 28 Front Power Seat Switch Assembly RH
- c 29 Front Lumbar Support Forward and Back Motor Assembly RH
- c 30 Front Seat Inner Belt Assembly LH
- c 31 Seat Climate Control Blower RH
- c 32 Seat Climate Control ECU RH
- c 33 Front Seat Cushion Heater Assembly RH
- c 34 Seat Climate Control Blower LH
- c 35 Seat Climate Control ECU LH
- c 36 Front Seat Cushion Heater Assembly LH
- z 57 Front Side Airbag Squib Circuit LH
- z 58 Front Side Airbag Squib Circuit RH

Position of Parts in Seat <RHD Front Separate Seat Type>

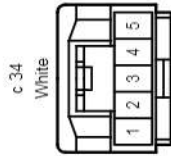
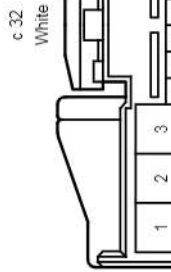
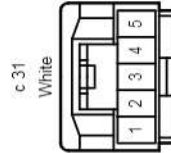
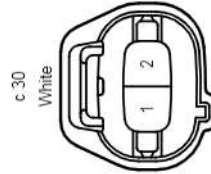
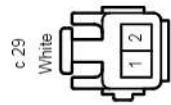
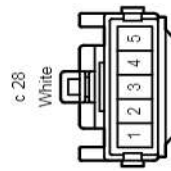
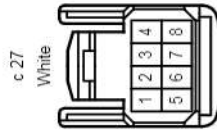
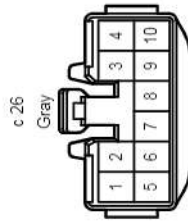
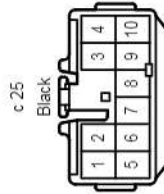
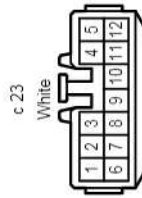
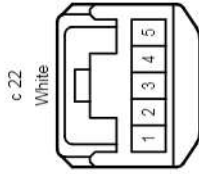
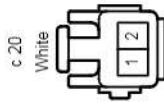
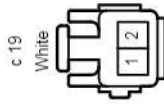
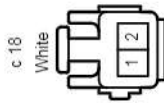
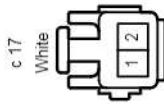
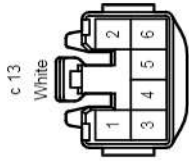
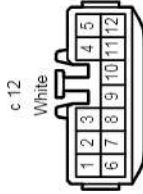
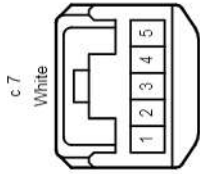
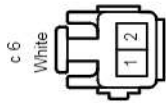
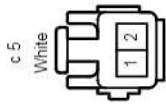
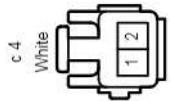
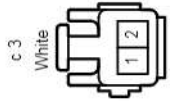
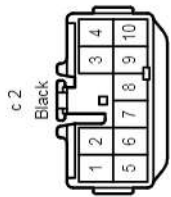
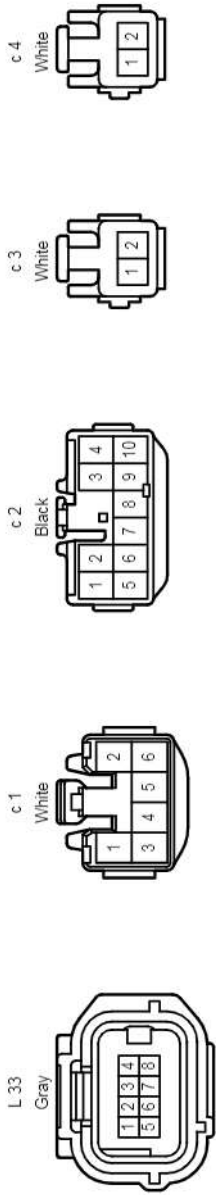

Wire and Wire in Seat <RHD Front Separate Seat Type>

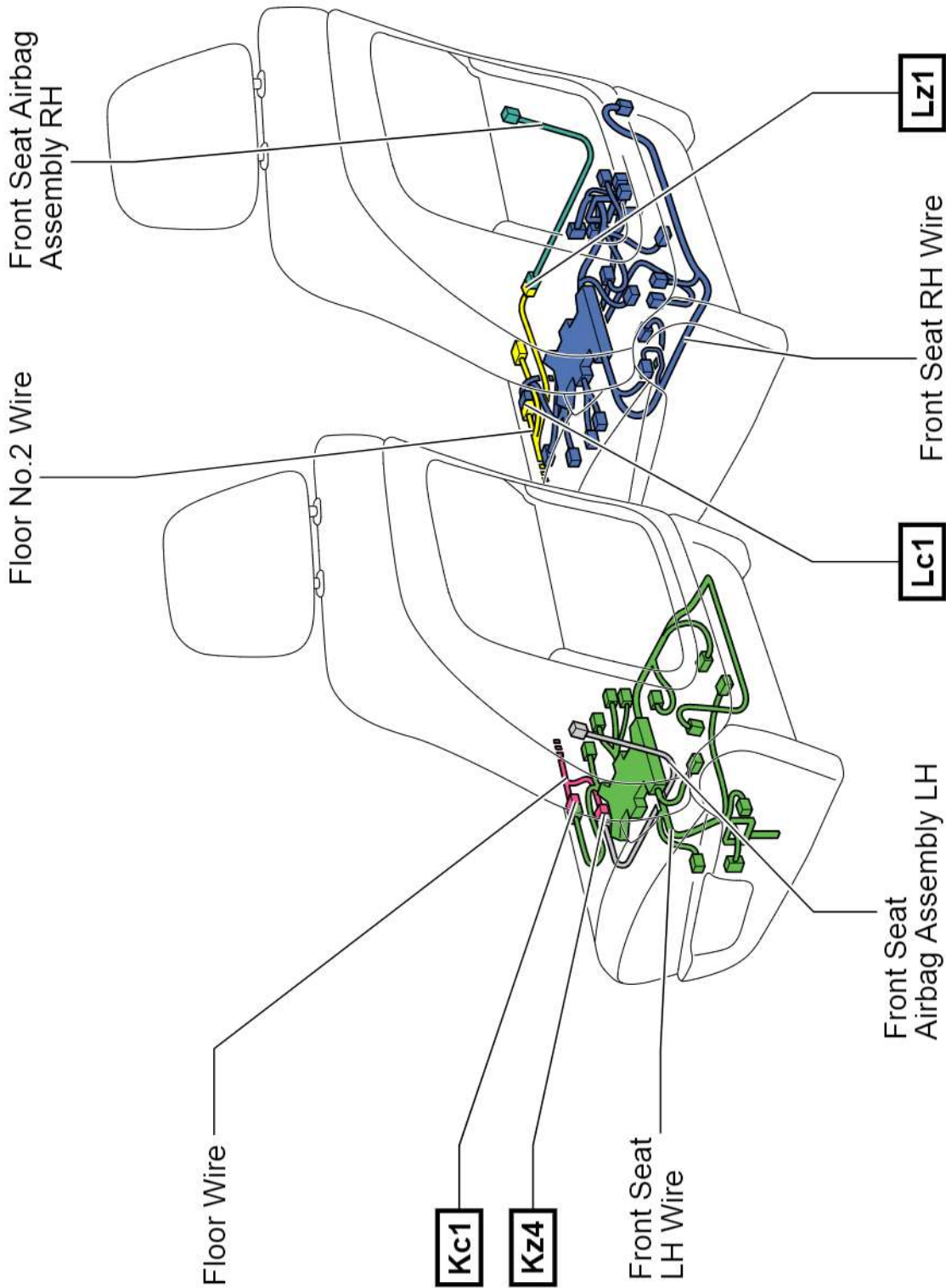

Wire and Wire in Seat <RHD Front Separate Seat Type>

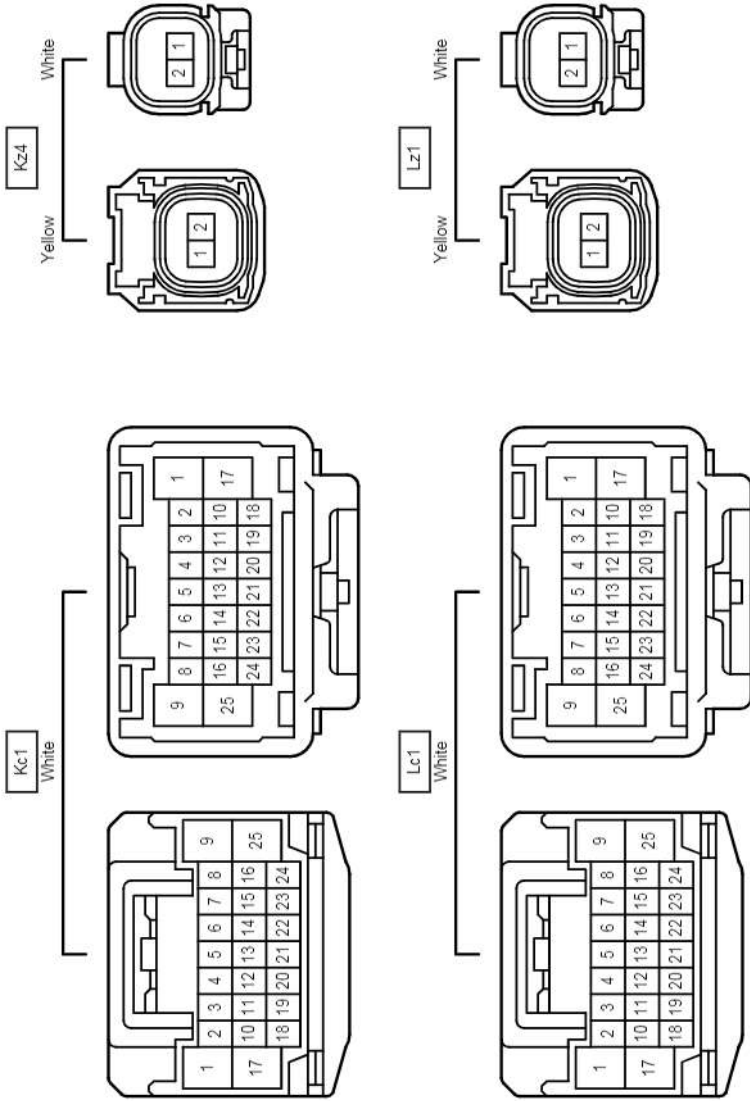

Ground Points in Instrument Panel <LHD Front Bench Seat Type>

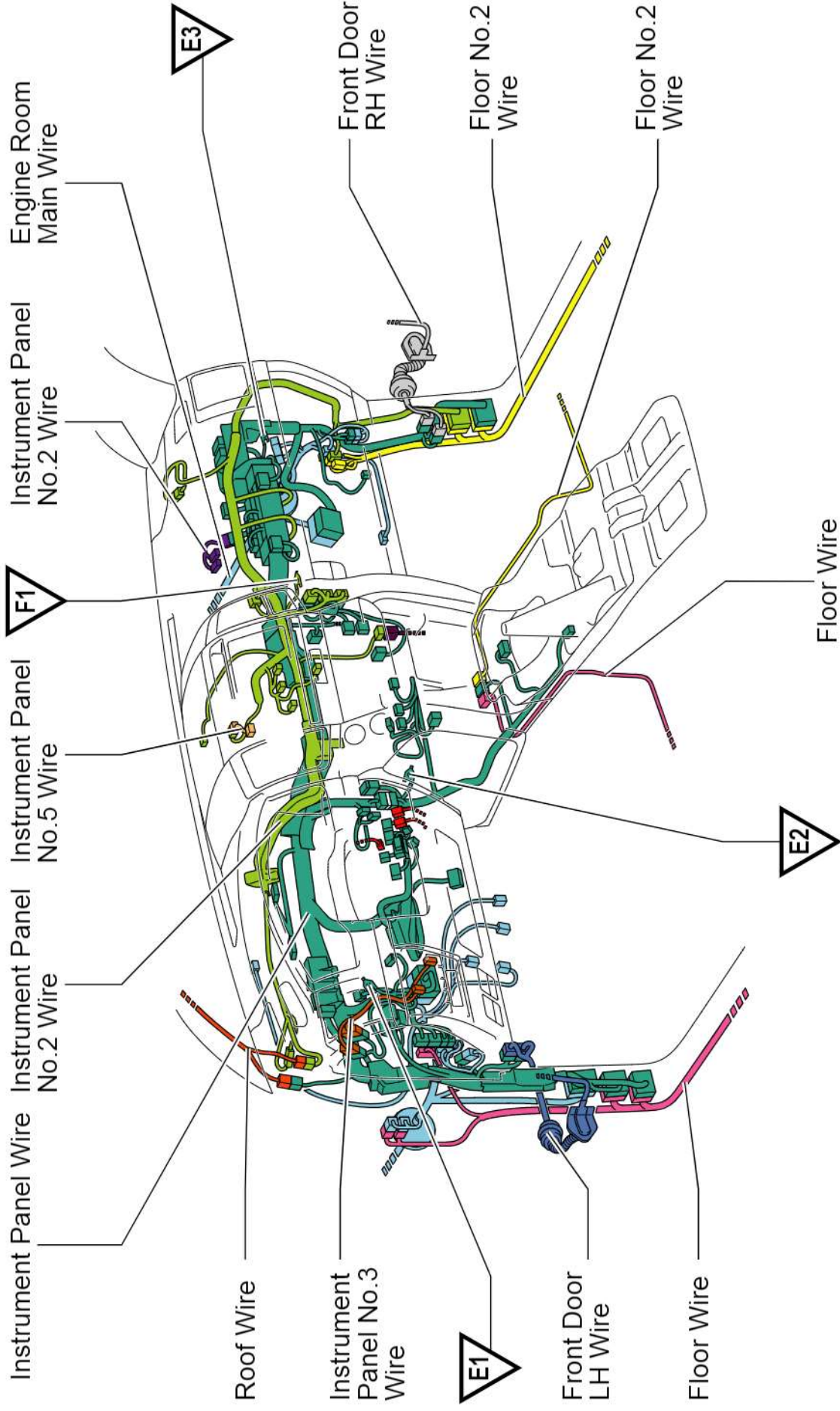

Position of Parts in Instrument Panel <LHD Front Bench Seat Type>

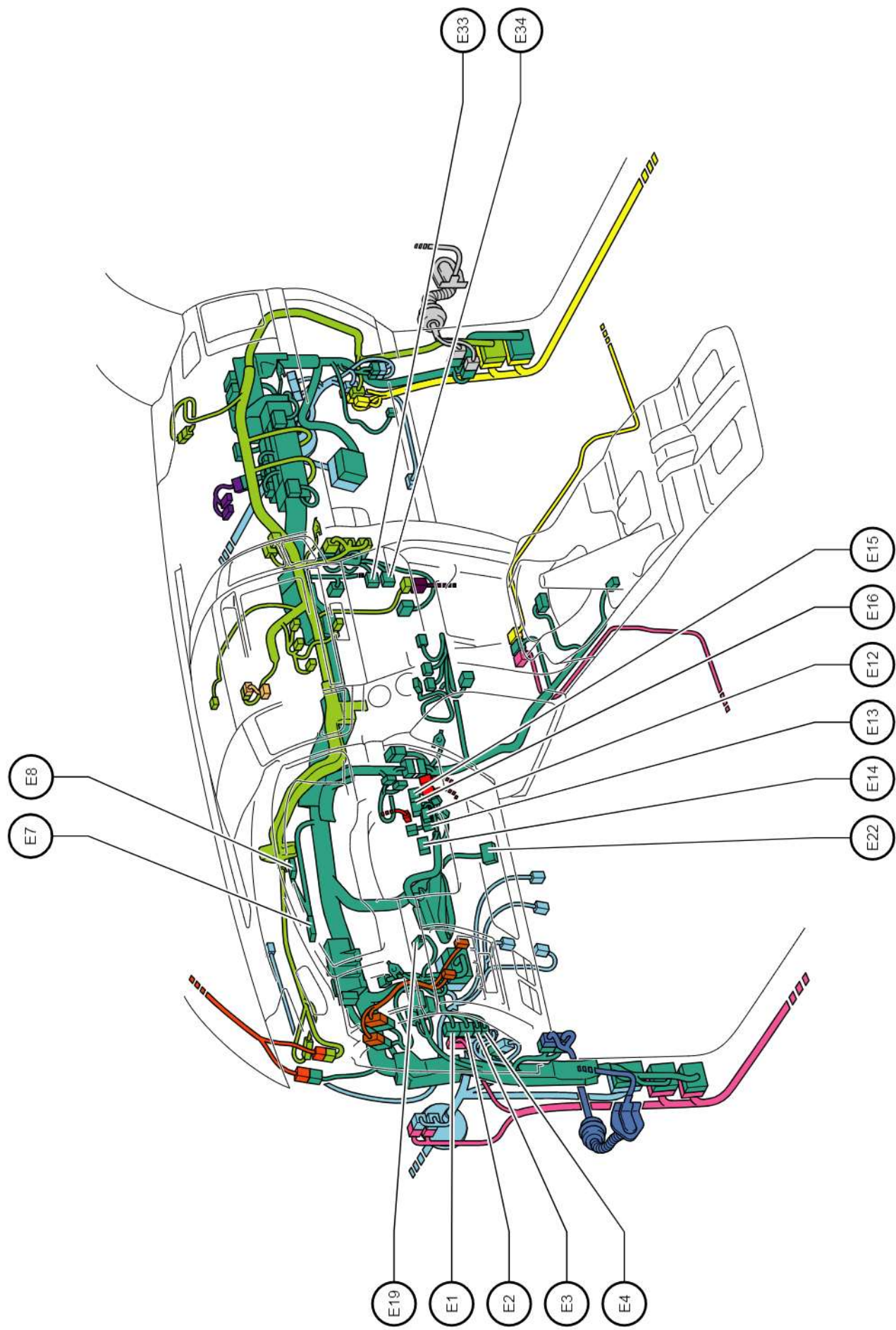

Position of Parts in Instrument Panel <LHD Front Bench Seat Type>

- E 1 Main Body ECU
- E 2 Main Body ECU
- E 3 Main Body ECU
- E 4 Main Body ECU
- E 7 Combination Meter Assembly
- E 8 Combination Meter Assembly
- E 12 Spiral Cable Sub-Assembly
- E 13 Spiral Cable Sub-Assembly
- E 14 Headlight Dimmer Switch Assembly
- E 15 Windshield Wiper Switch Assembly
- E 16 Windshield Wiper Switch Assembly
- E 19 Turn Signal Flasher Assembly
- E 22 DLC3
- E 33 Quick Heater Assembly
- E 34 Quick Heater Assembly

Position of Parts in Instrument Panel <LHD Front Bench Seat Type>

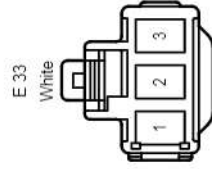
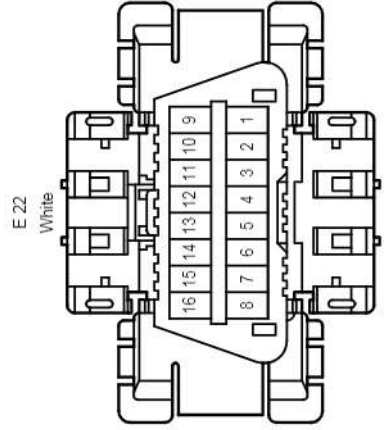
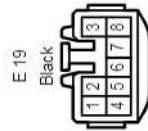
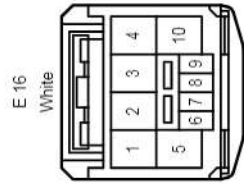
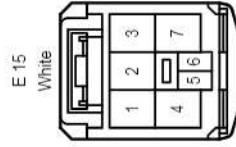
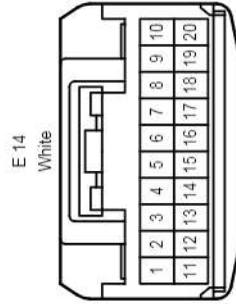
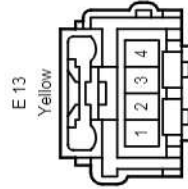
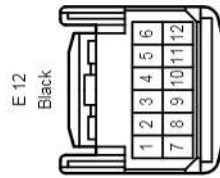
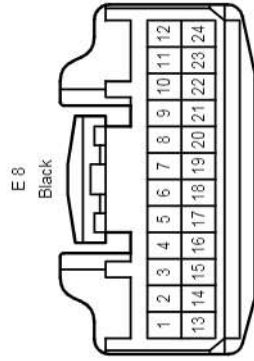
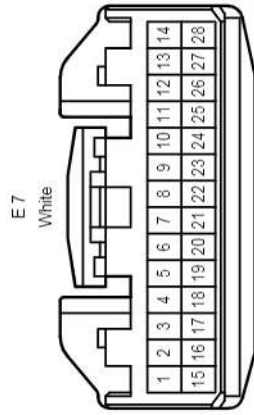
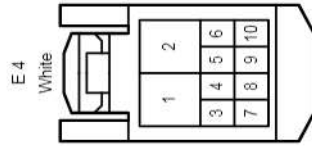
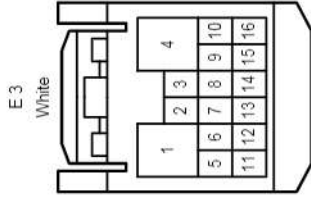
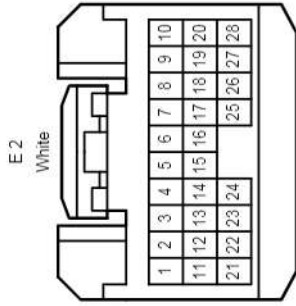
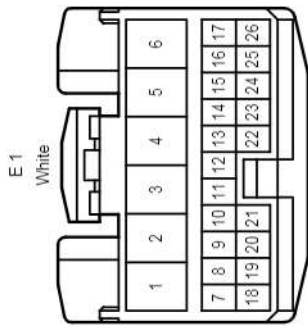

Position of Parts in Instrument Panel <LHD Front Bench Seat Type>

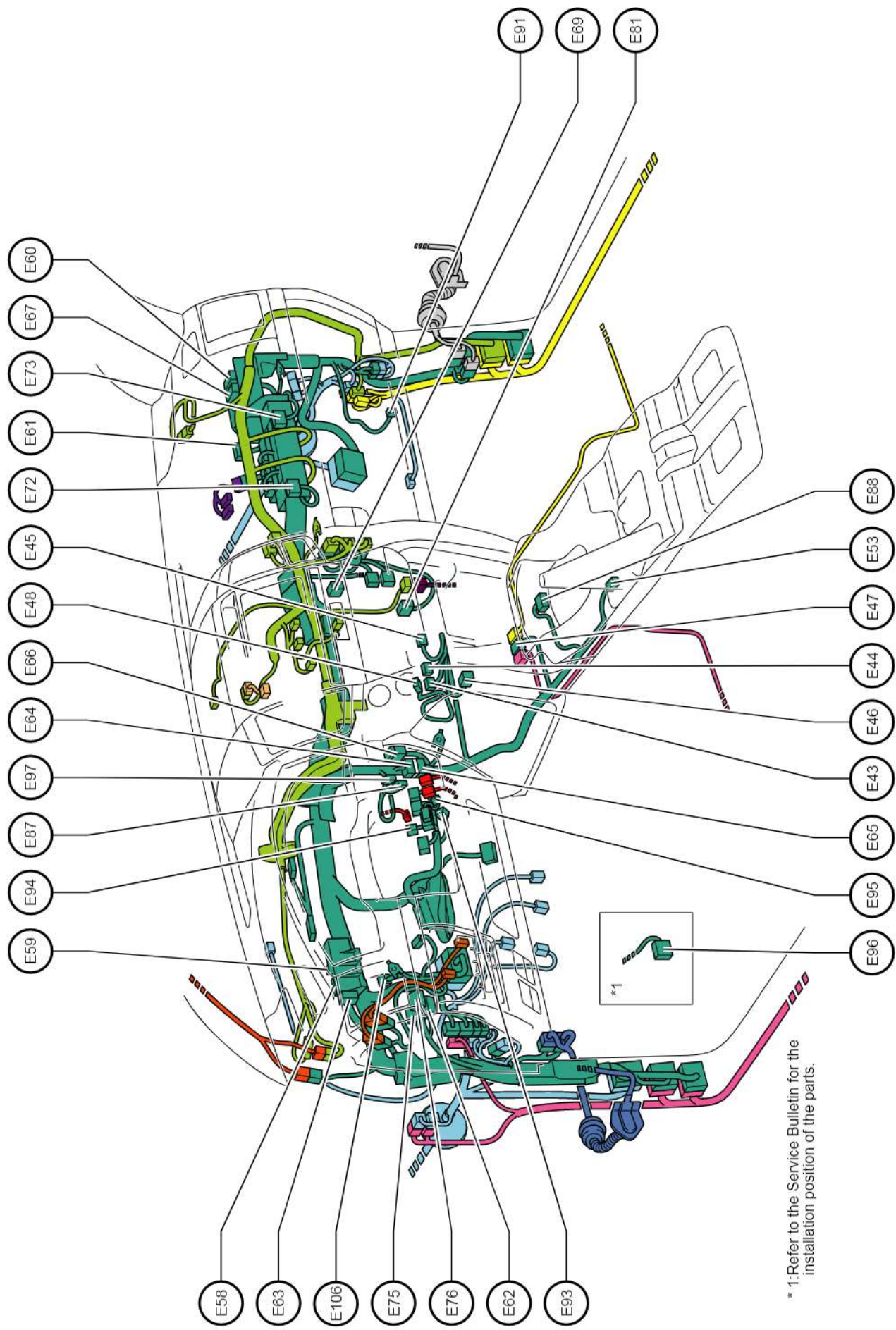

* 1: Refer to the Service Bulletin for the installation position of the parts.

- E 43 Cigarette Lighter Assembly
- E 44 Cigarette Lighter Illumination Assembly
- E 45 Ash Receptacle Light Sub-Assembly
- E 46 Front Power Outlet Socket Assembly
- E 47 Center Airbag Sensor Assembly
- E 48 Transfer Position Switch
- E 53 Parking Brake Switch Assembly
- E 58 Junction Connector
- E 59 Junction Connector
- E 60 Junction Connector
- E 61 Junction Connector
- E 62 Junction Connector
- E 63 Junction Connector
- E 64 Junction Connector
- E 65 Junction Connector
- E 66 Junction Connector
- E 67 Junction Connector
- E 69 Junction Connector
- E 72 Junction Connector
- E 73 Junction Connector
- E 75 Junction Connector
- E 76 Junction Connector
- E 81 A/C Amplifier Assembly
- E 87 Differential Lock Switch
- E 88 Deceleration Sensor
- E 91 Option Connector (Parking Assist-Sensor)
- E 93 Ignition or Starter Switch Assembly
- E 94 Un-Lock Warning Switch Assembly
- E 95 Transponder Key Amplifier
- E 96 Transponder Key ECU Assembly
- E 97 Idle Up Switch
- E 106 Junction Connector

Position of Parts in Instrument Panel <LHD Front Bench Seat Type>

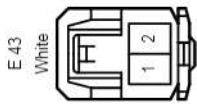

E 43
White



E 44
Gray

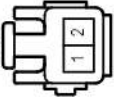

E 45
White

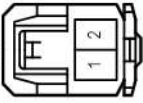

E 46
White

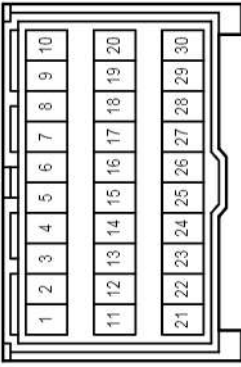

E 47
Yellow

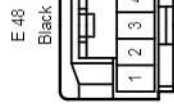

E 48
Black



E 53
White

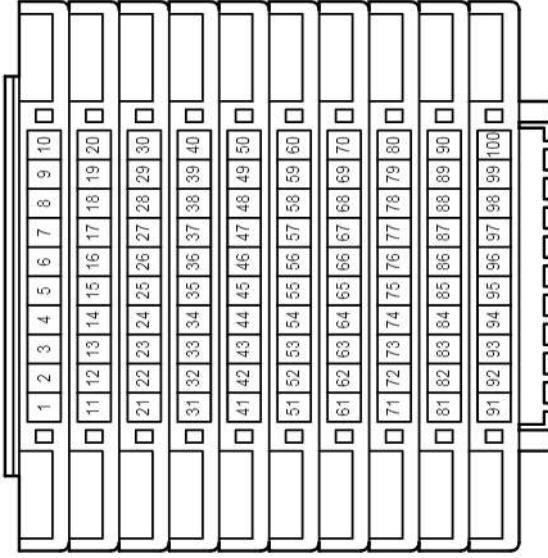

E 58

E 59

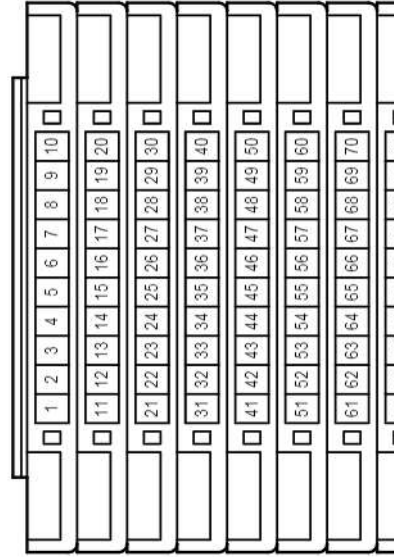

E 60

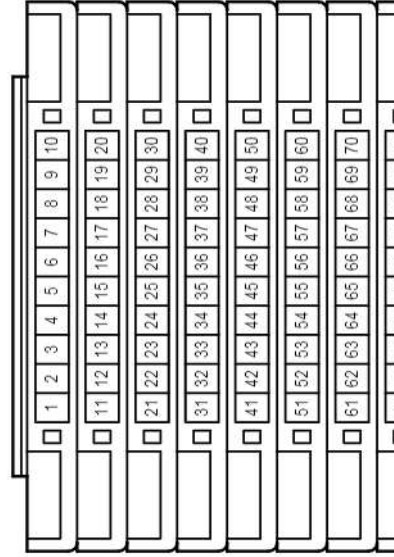

Position of Parts in Instrument Panel <LHD Front Bench Seat Type>

E 61

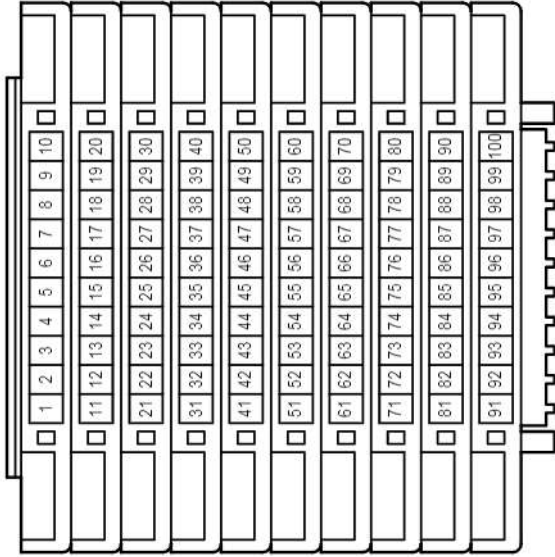

E 62
White

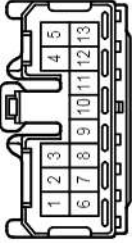

E 63
Gray

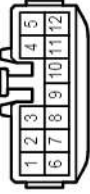

E 64
Black

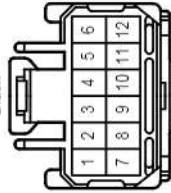

E 65
Black

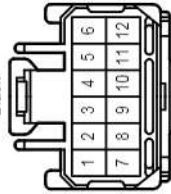

E 66
White

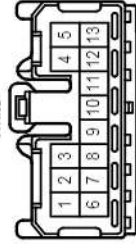

E 67
White

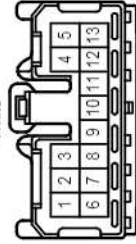

E 69
Gray

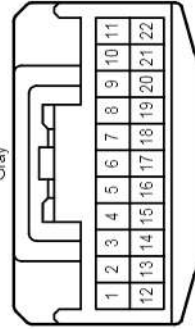

E 72
Gray

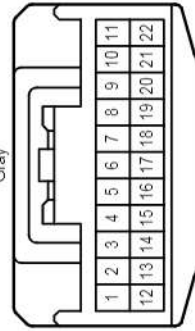

E 73
Gray

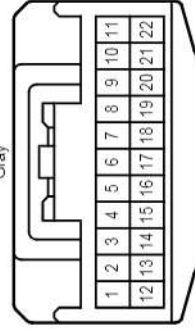

E 75
Gray

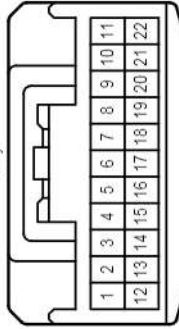

E 76
Gray

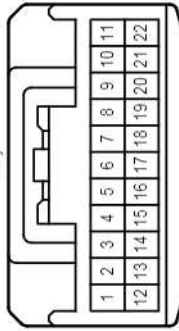

Position of Parts in Instrument Panel <LHD Front Bench Seat Type>

E 91
White

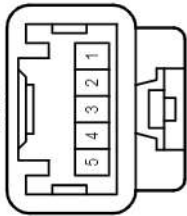

E 93
White

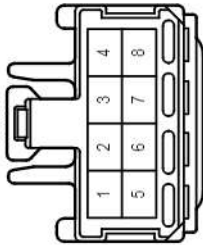

E 94
White



E 95
Black

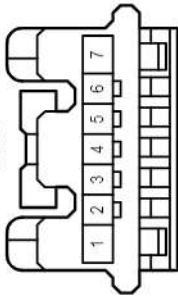

E 96
Black

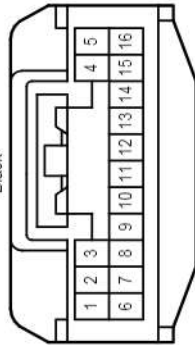

E 97
Black

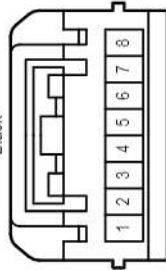

E106
White

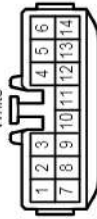

Position of Parts in Instrument Panel <LHD Front Bench Seat Type>

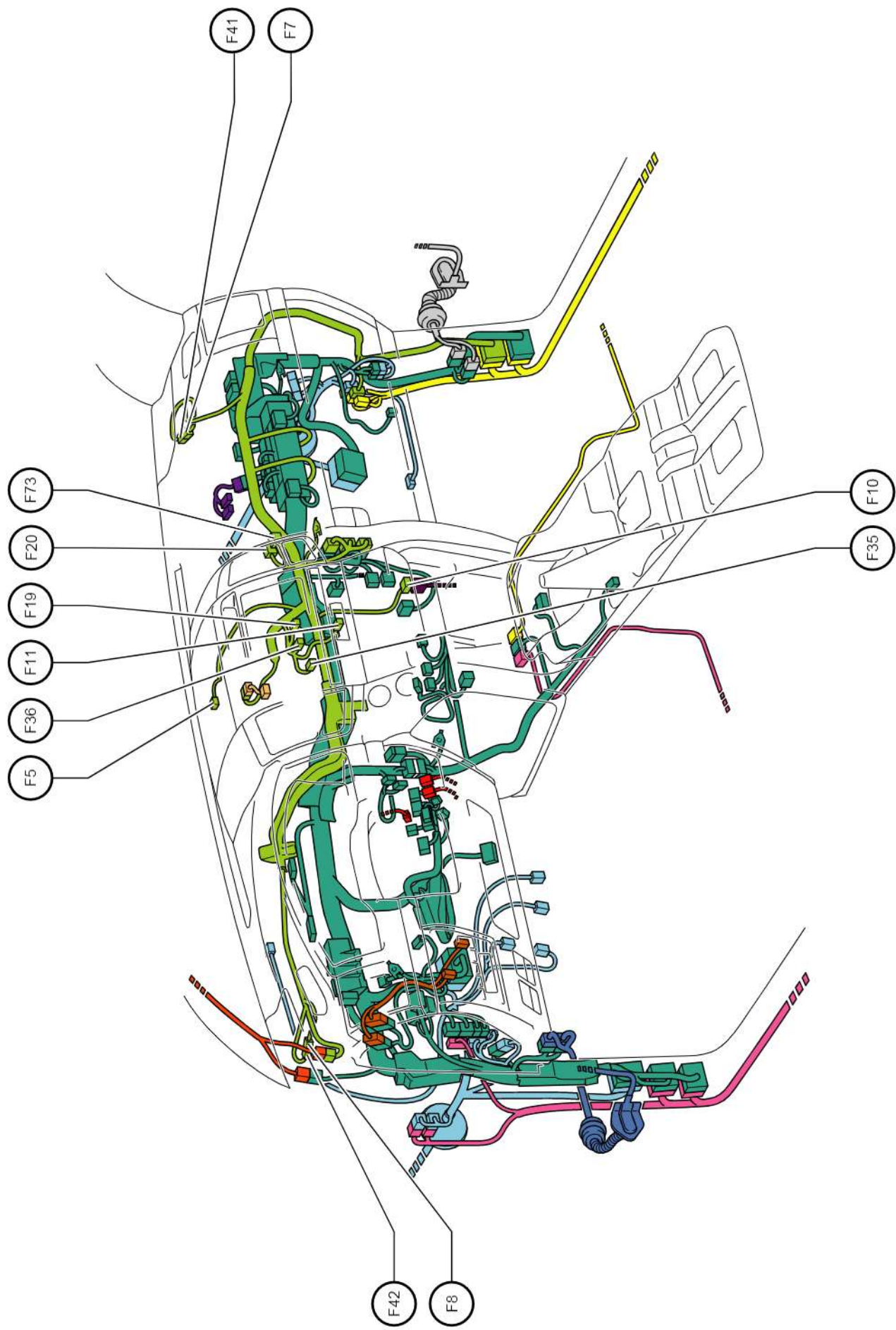

Position of Parts in Instrument Panel <LHD Front Bench Seat Type>

- F 5 Amplifier Antenna Assembly
- F 7 Front No.2 Speaker Assembly RH , Short Connector
- F 8 Front No.2 Speaker Assembly LH , Short Connector
- F 10 A/C Control Assembly
- F 11 Hazard Warning Signal Switch Assembly
- F 19 Radio Receiver Assembly
- F 20 Junction Connector
- F 35 Radio Receiver Assembly
- F 36 Radio Receiver Assembly
- F 41 Short Connector
- F 42 Short Connector
- F 73 Junction Connector

Position of Parts in Instrument Panel <LHD Front Bench Seat Type>

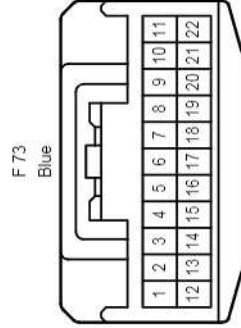
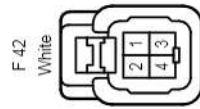
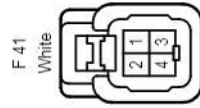
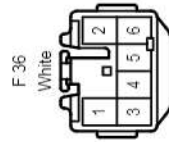
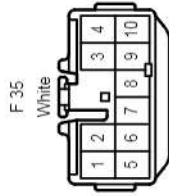
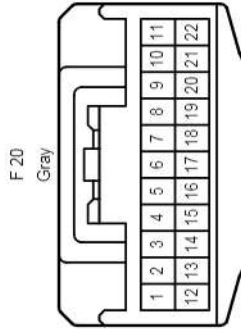
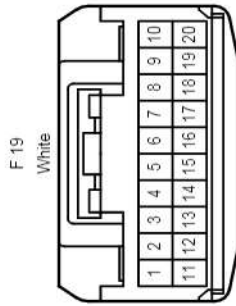
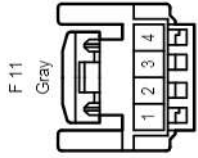
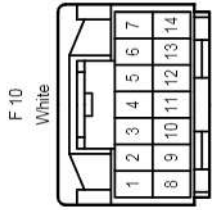
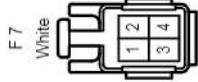

Position of Parts in Instrument Panel <LHD Front Bench Seat Type>

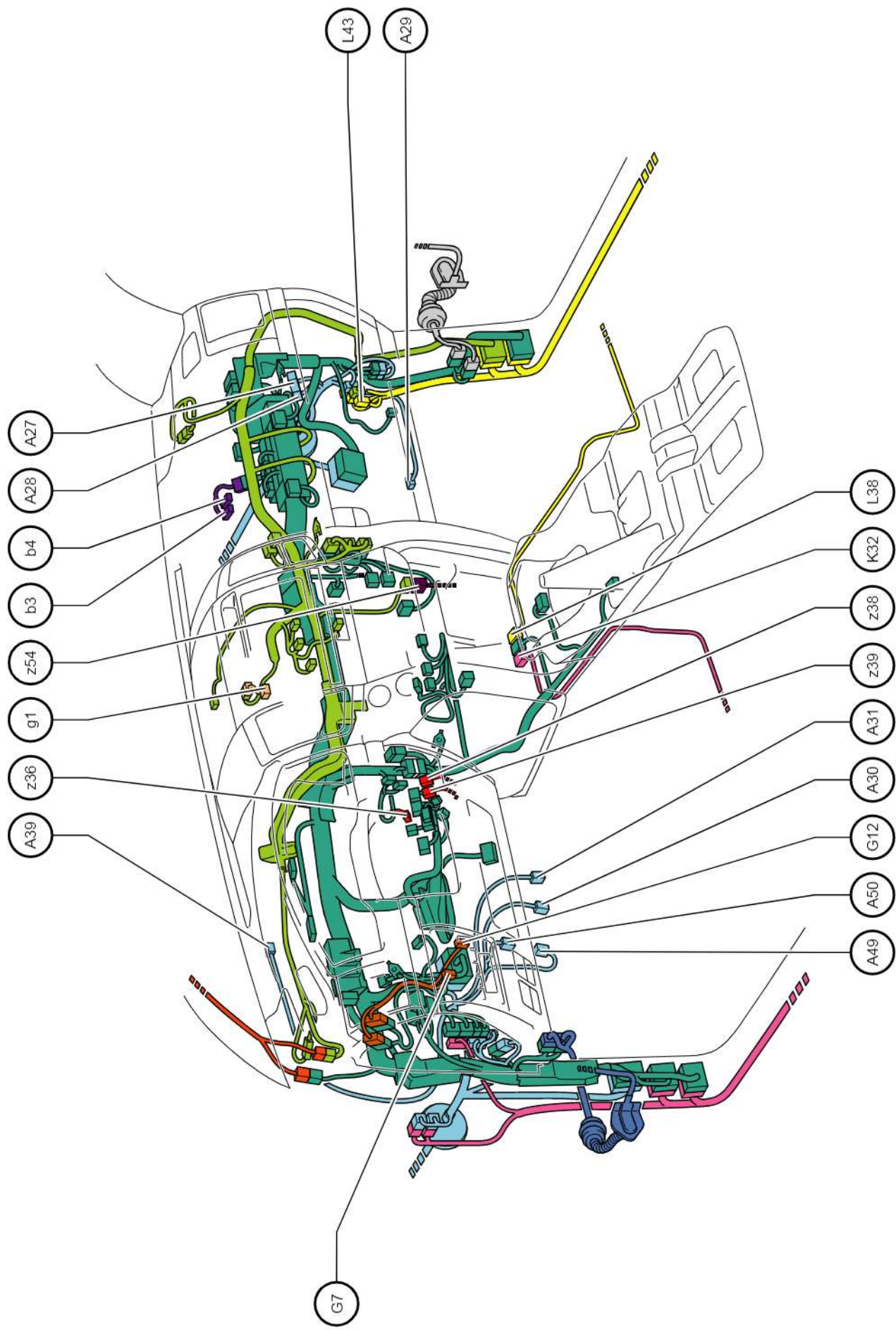

Position of Parts in Instrument Panel <LHD Front Bench Seat Type>

- A 27 Four Wheel Drive Control ECU
- A 28 Four Wheel Drive Control ECU
- A 29 Front Blower with Fan Motor Sub-Assembly
- A 30 Stop Light Switch Assembly
- A 31 Accelerator Pedal Sensor Assembly
- A 39 Stop Light Control Relay Assembly
- A 49 Clutch Start Switch Assembly
- A 50 Clutch Switch Assembly

- G 7 Outer Mirror Switch Assembly
- G 12 Center Differential Lock Switch

- K 32 Center Airbag Sensor Assembly

- L 38 Center Airbag Sensor Assembly
- L 43 Option Connector (Parking Assist-Sensor)

- b 3 Front Passenger Side Squib Circuit
- b 4 Front Passenger Side Squib Circuit

- g 1 Clock Assembly

- z 36 Spiral Cable Sub-Assembly , Steering Pad Switch
- z 38 Driver Side Squib 2nd Step Circuit , Spiral Cable Sub-Assembly
- z 39 Driver Side Squib Circuit , Spiral Cable Sub-Assembly
- z 54 A/C Amplifier Assembly , A/C Blower Assembly

Position of Parts in Instrument Panel <LHD Front Bench Seat Type>

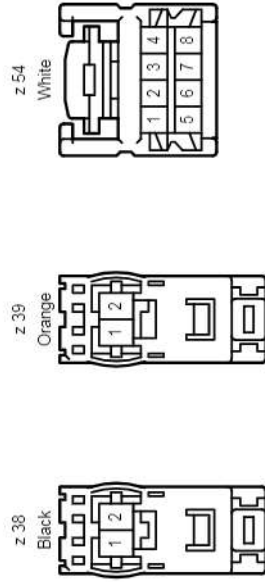
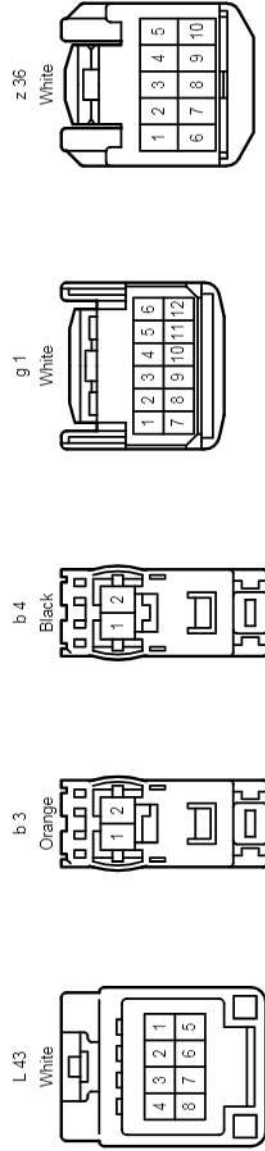
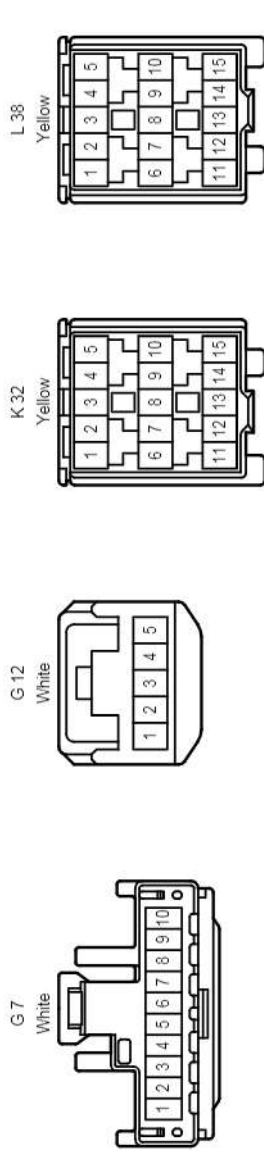
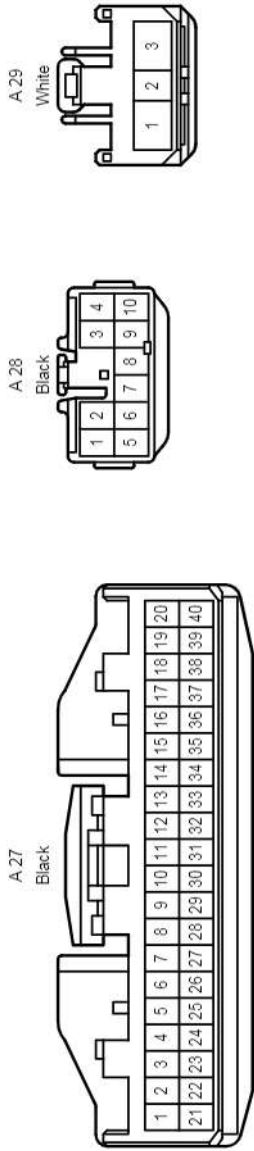

Wire and Wire in Instrument Panel <LHD Front Bench Seat Type>

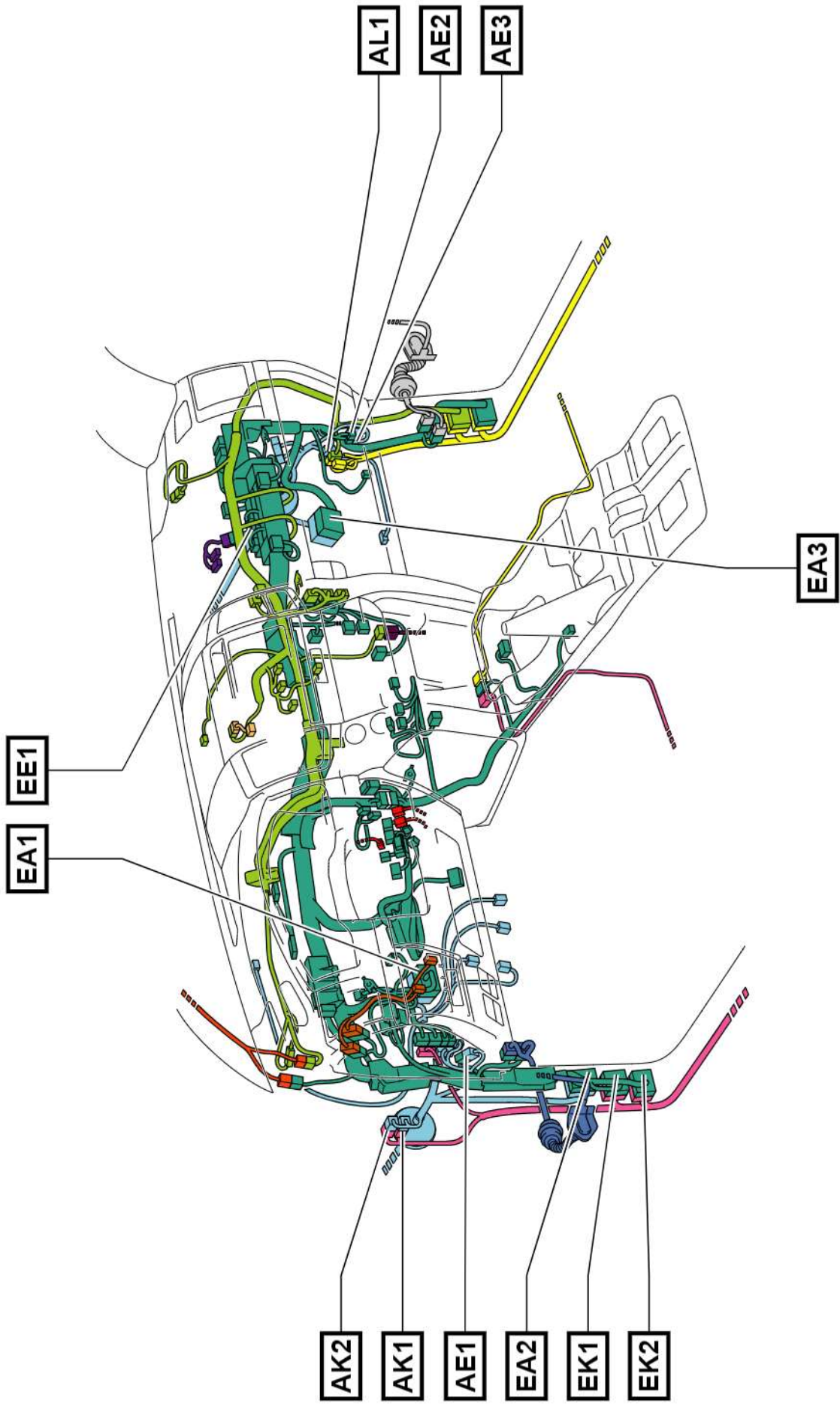

Wire and Wire in Instrument Panel <LHD Front Bench Seat Type>

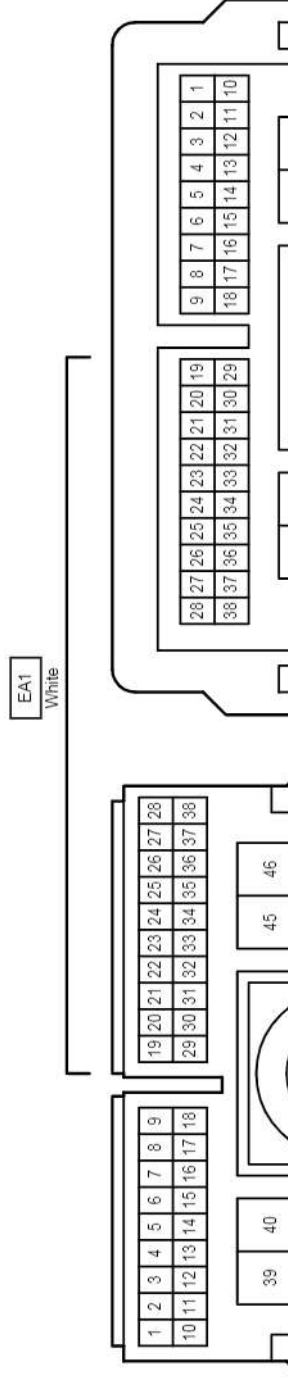
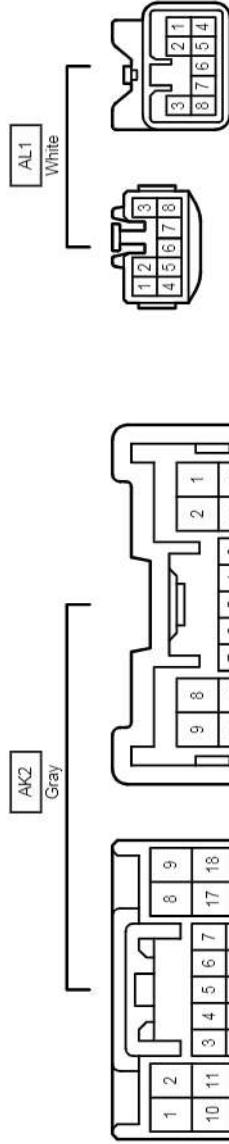
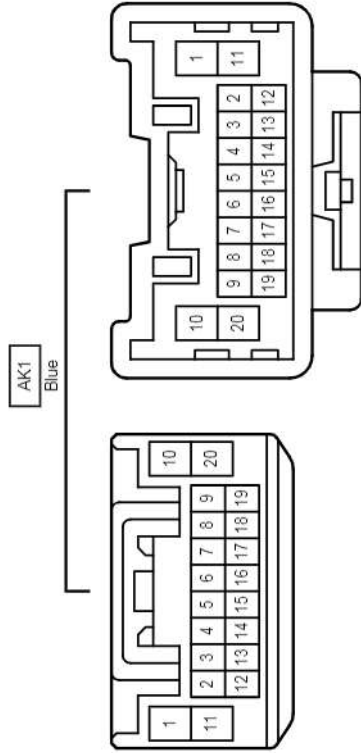
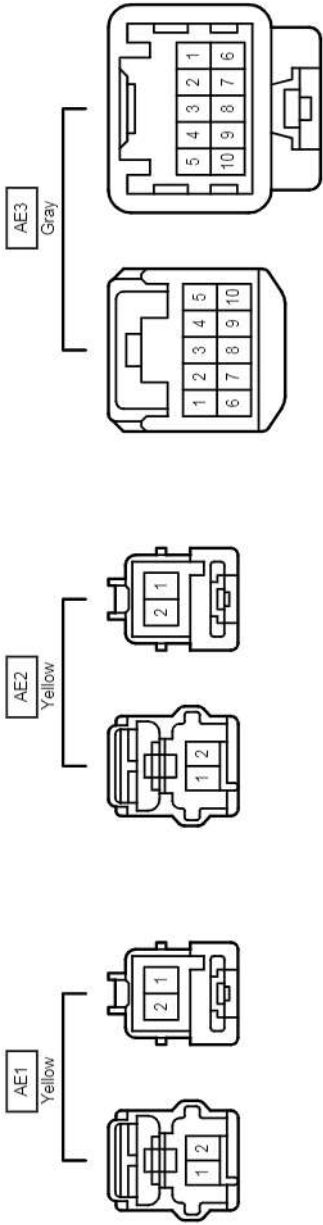

Wire and Wire in Instrument Panel <LHD Front Bench Seat Type>

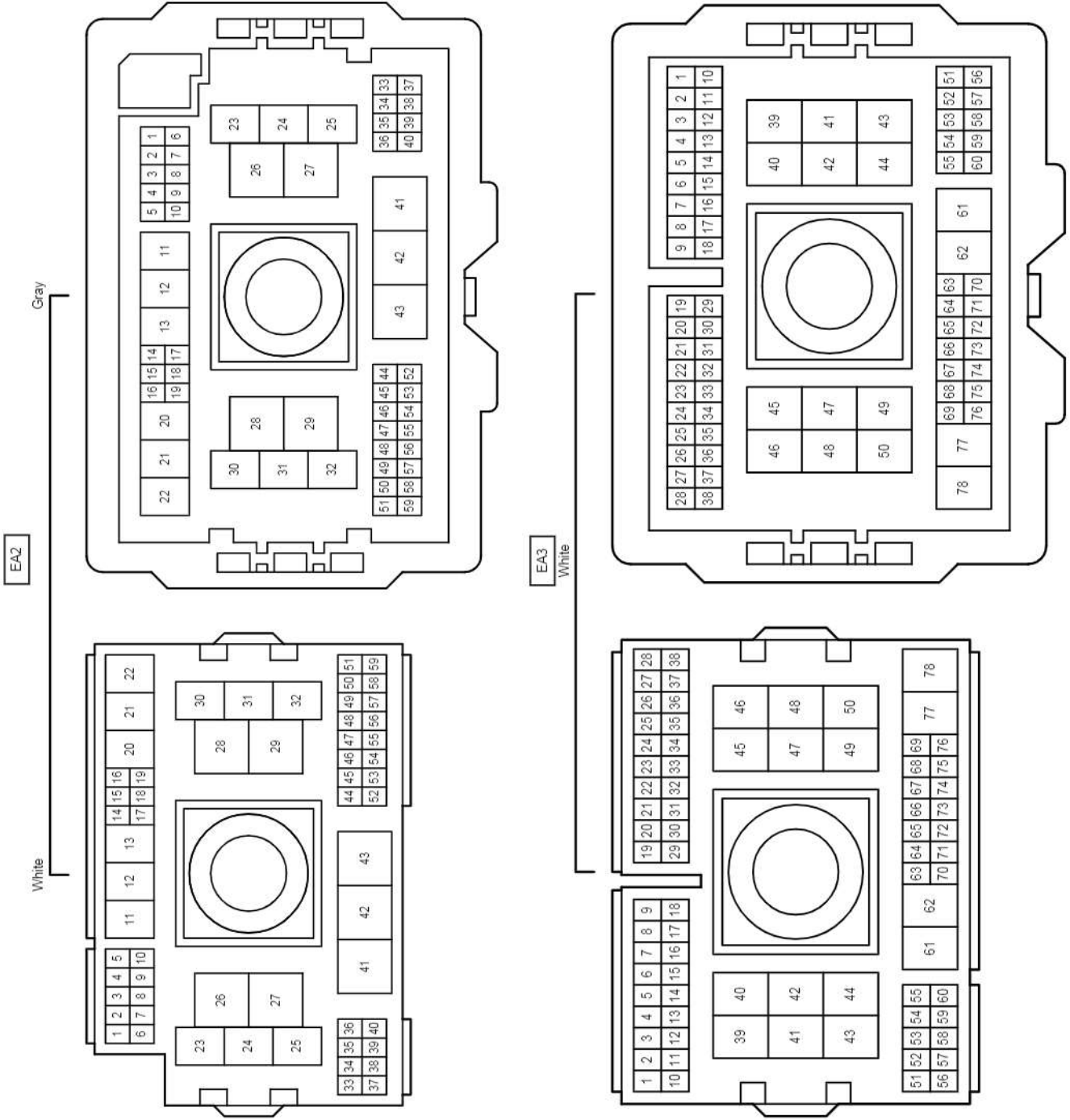

cardiagn.com

Wire and Wire in Instrument Panel <LHD Front Bench Seat Type>

EK1

Blue

White

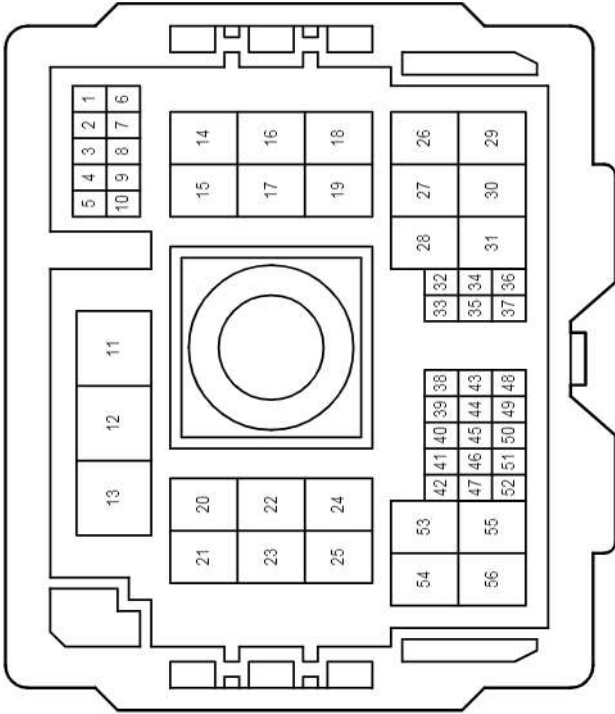

EK2

White

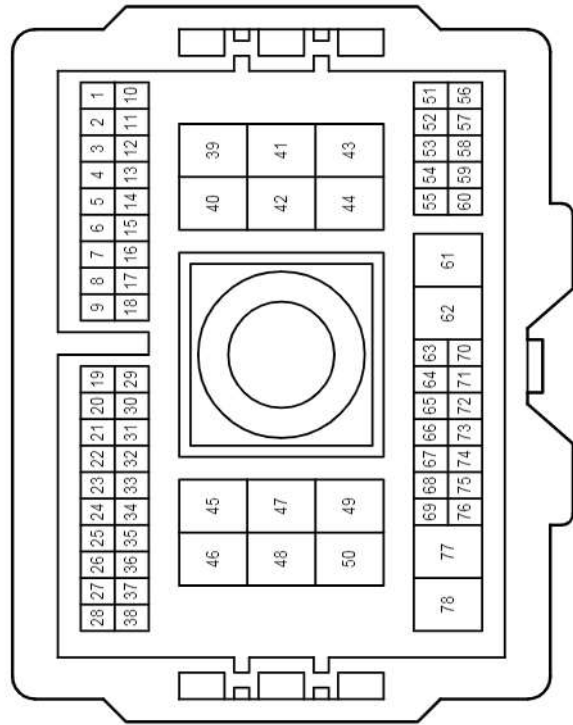

cardiagn.com

Wire and Wire in Instrument Panel <LHD Front Bench Seat Type>

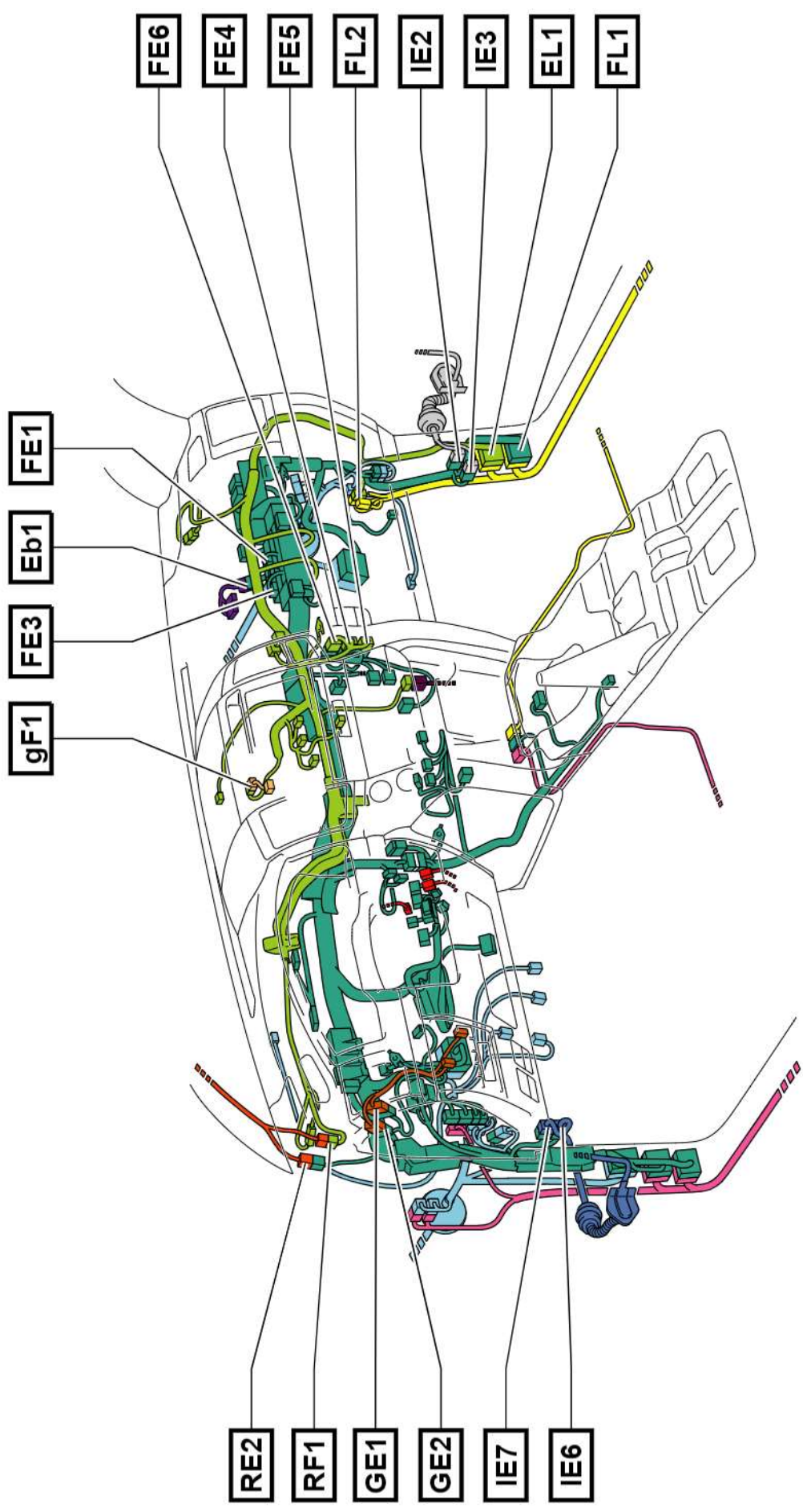

Wire and Wire in Instrument Panel <LHD Front Bench Seat Type>

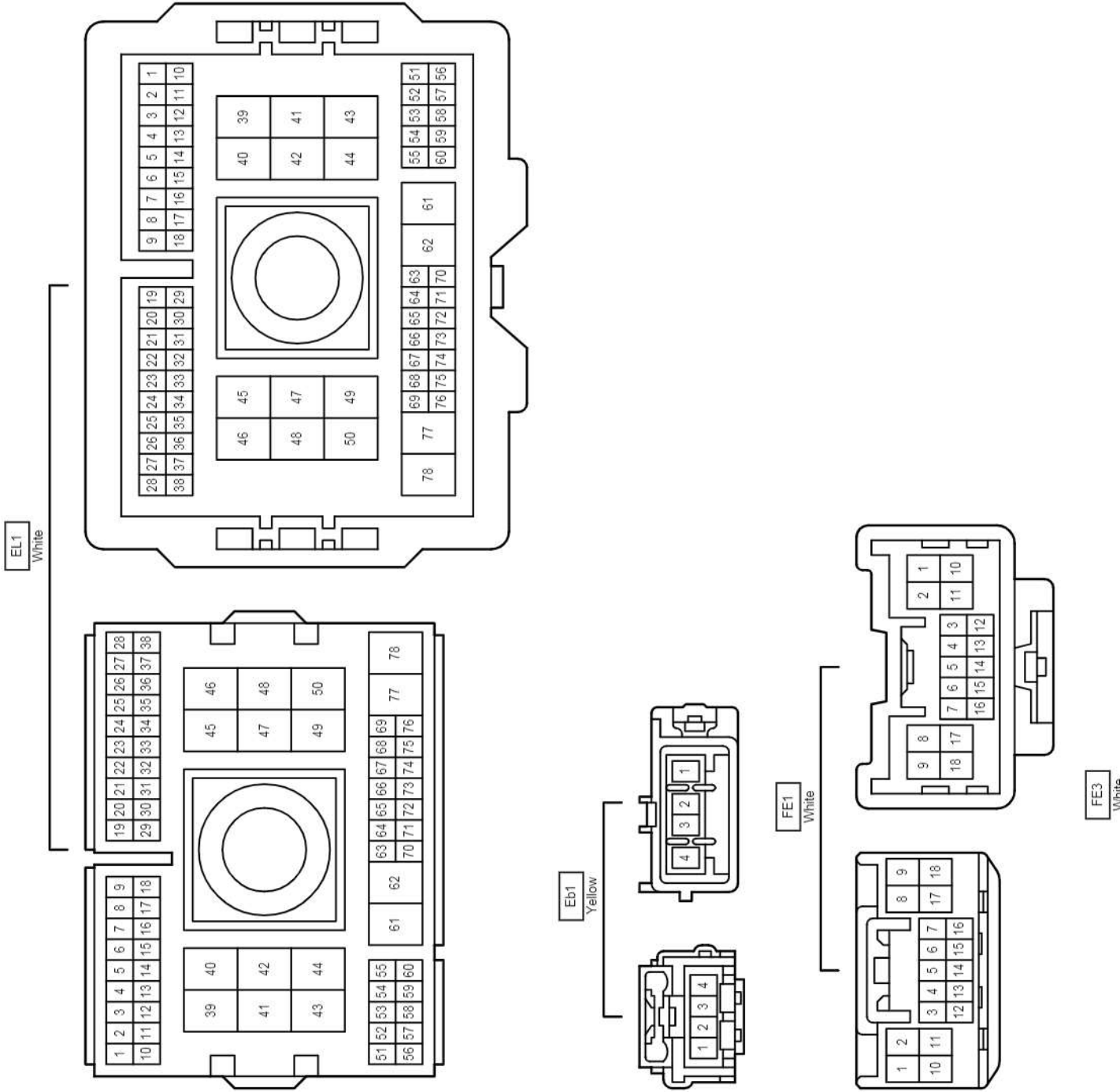

Wire and Wire in Instrument Panel <LHD Front Bench Seat Type>

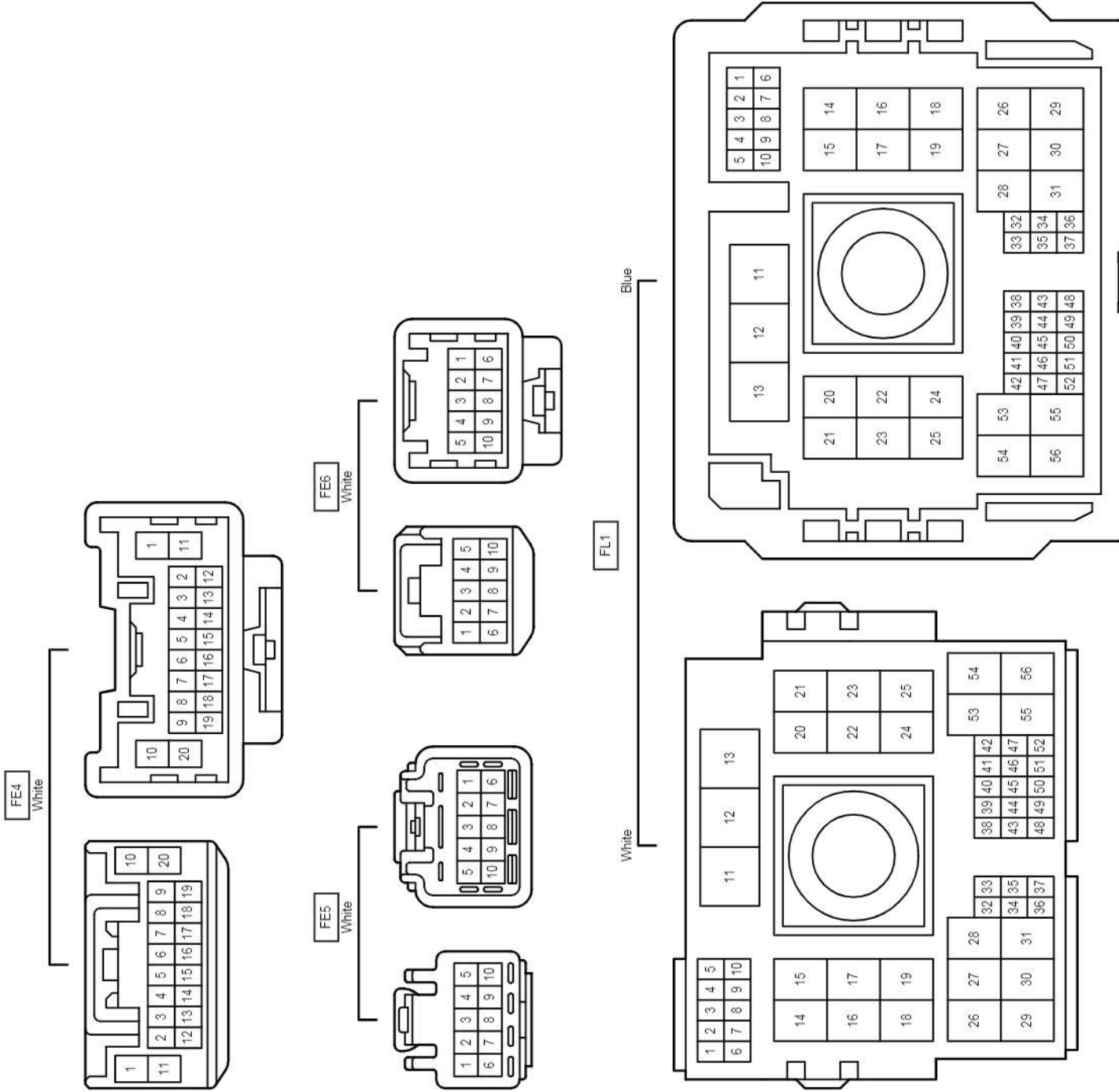

Wire and Wire in Instrument Panel <LHD Front Bench Seat Type>

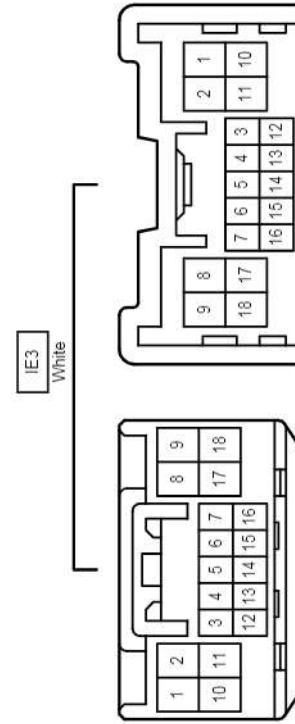
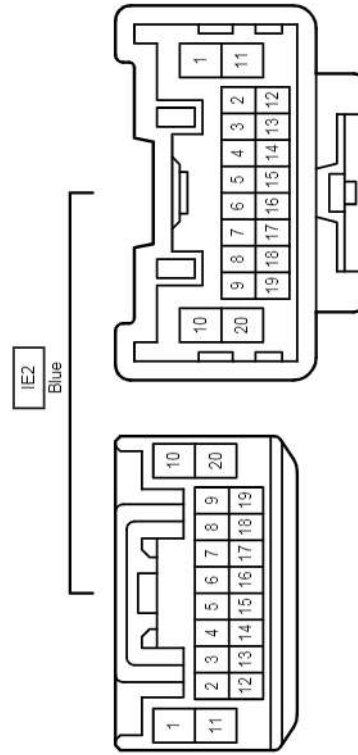
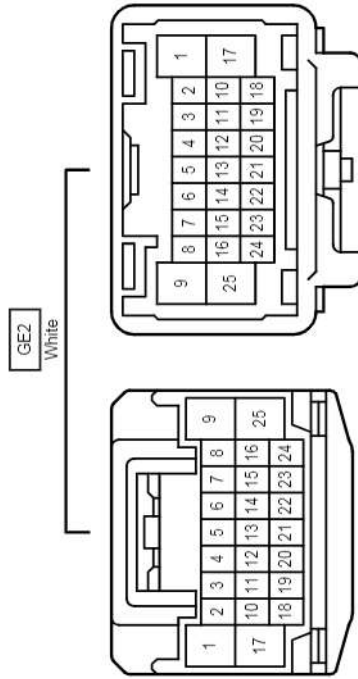
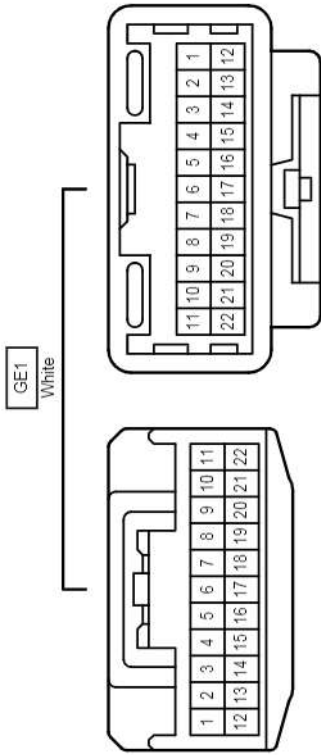

Wire and Wire in Instrument Panel <LHD Front Bench Seat Type>

IE6
White

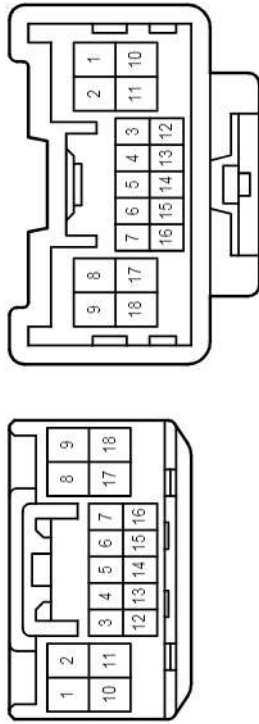

IE7
White

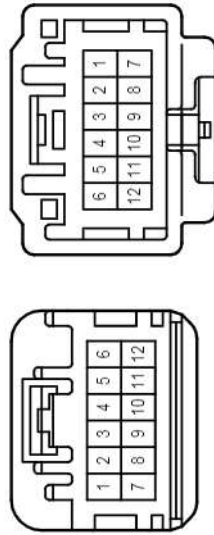

RE2
Blue

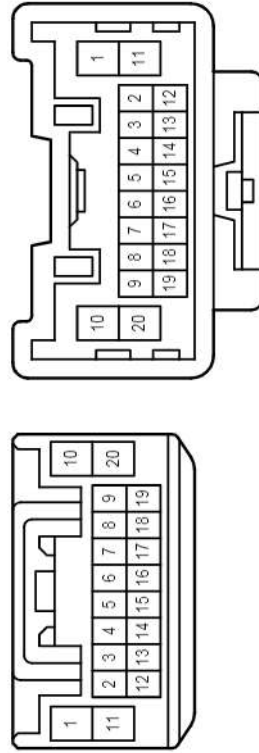

RF1
Gray

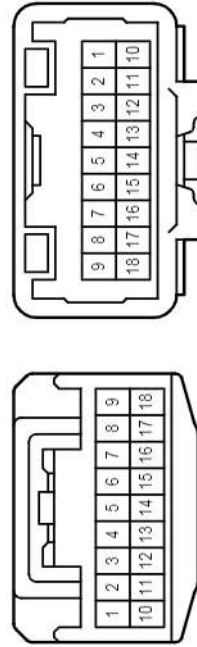

gF1
Black

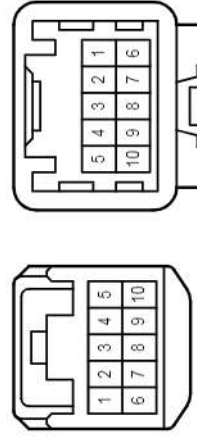

Ground Points in Instrument Panel <RHD Front Bench Seat Type>

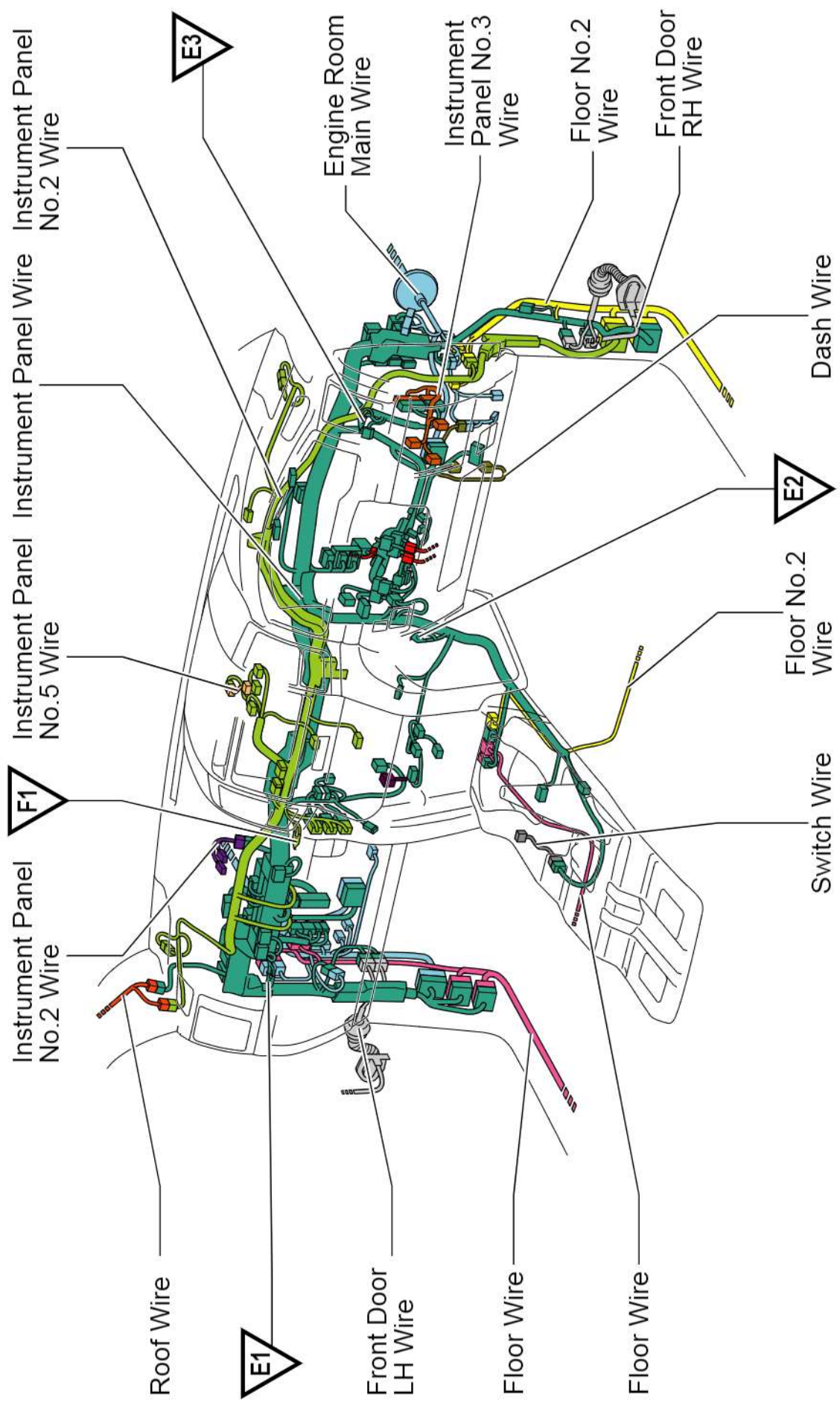

Position of Parts in Instrument Panel <RHD Front Bench Seat Type>

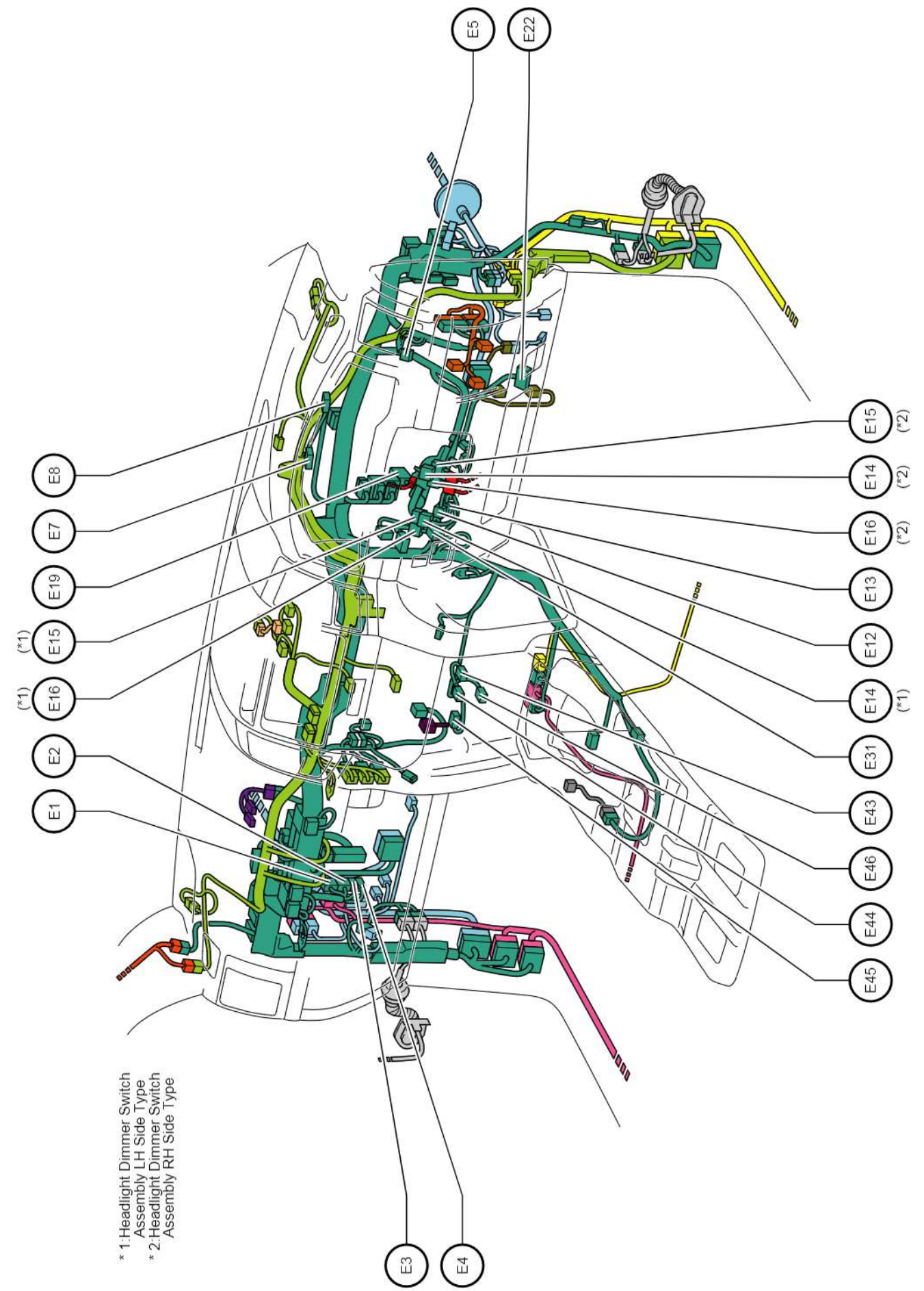

* 1: Headlight Dimmer Switch
 Assembly LH Side Type
 * 2: Headlight Dimmer Switch
 Assembly RH Side Type

Position of Parts in Instrument Panel <RHD Front Bench Seat Type>

- E 1 Main Body ECU
- E 2 Main Body ECU
- E 3 Main Body ECU
- E 4 Main Body ECU
- E 5 Skid Control Buzzer Assembly
- E 7 Combination Meter Assembly
- E 8 Combination Meter Assembly
- E 12 Spiral Cable Sub-Assembly
- E 13 Spiral Cable Sub-Assembly
- E 14 Headlight Dimmer Switch Assembly
- E 15 Windshield Wiper Switch Assembly
- E 16 Windshield Wiper Switch Assembly
- E 19 Turn Signal Flasher Assembly
- E 22 DLC3
- E 31 Network Gateway ECU
- E 43 Cigarette Lighter Assembly
- E 44 Cigarette Lighter Illumination Assembly
- E 45 Ash Receptacle Light Sub-Assembly
- E 46 Front Power Outlet Socket Assembly

Position of Parts in Instrument Panel <RHD Front Bench Seat Type>

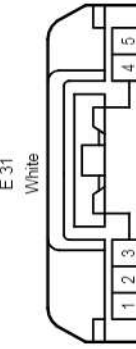
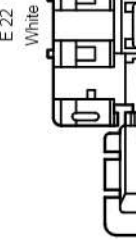
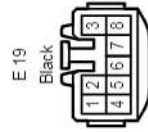
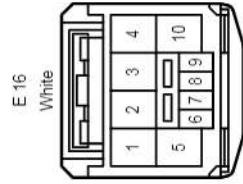
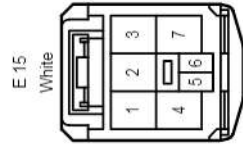
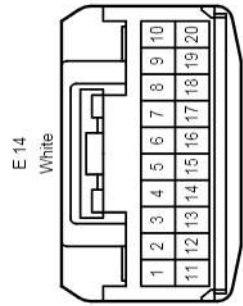
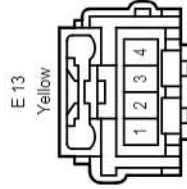
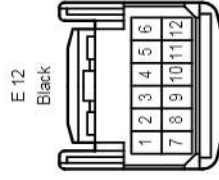
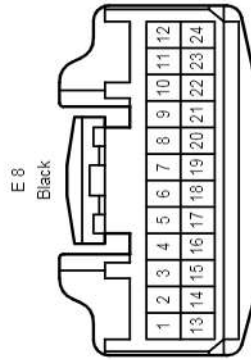
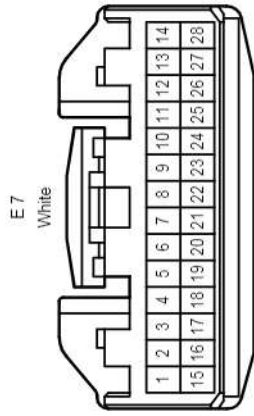
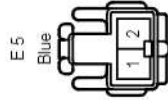
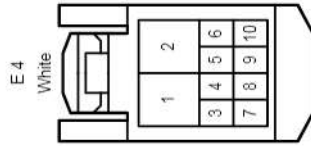
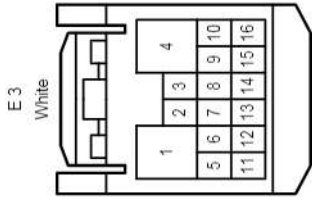
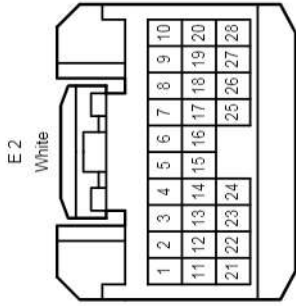
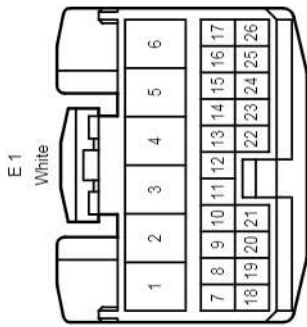

Position of Parts in Instrument Panel <RHD Front Bench Seat Type>

E 44
Gray



E 45
White

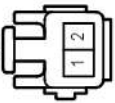

E 46
White

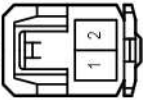

Position of Parts in Instrument Panel <RHD Front Bench Seat Type>

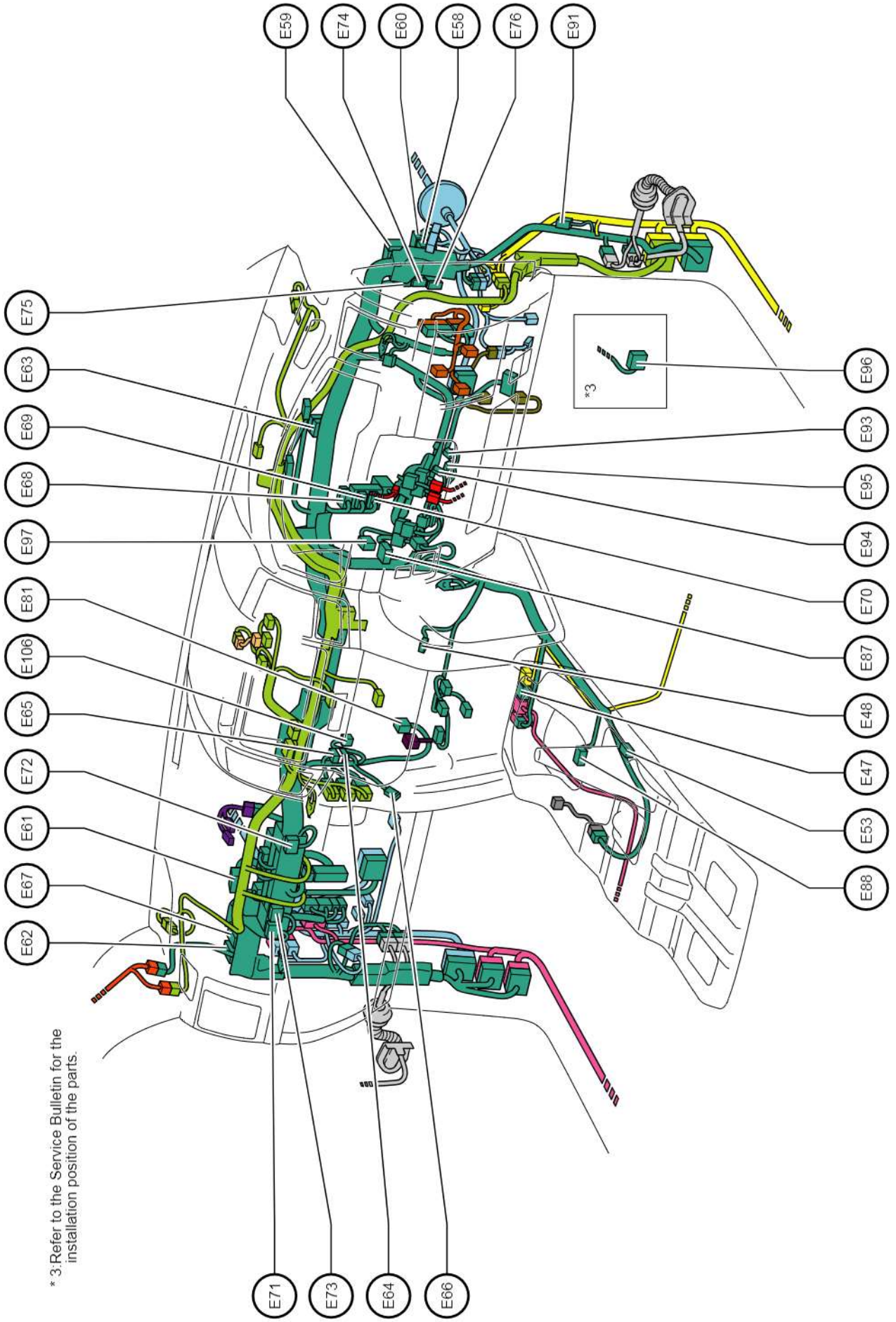

* 3: Refer to the Service Bulletin for the installation position of the parts.

Position of Parts in Instrument Panel <RHD Front Bench Seat Type>

- E 47 Center Airbag Sensor Assembly
- E 48 Transfer Position Switch
- E 53 Parking Brake Switch Assembly
- E 58 Junction Connector
- E 59 Junction Connector
- E 60 Junction Connector
- E 61 Junction Connector
- E 62 Junction Connector
- E 63 Junction Connector
- E 64 Junction Connector
- E 65 Junction Connector
- E 66 Junction Connector
- E 67 Junction Connector
- E 68 Junction Connector
- E 69 Junction Connector
- E 70 Junction Connector
- E 71 Junction Connector
- E 72 Junction Connector
- E 73 Junction Connector
- E 74 Junction Connector
- E 75 Junction Connector
- E 76 Junction Connector
- E 81 A/C Amplifier Assembly
- E 87 Differential Lock Switch
- E 88 Deceleration Sensor
- E 91 Option Connector (Parking Assist-Sensor)
- E 93 Ignition or Starter Switch Assembly
- E 94 Un-Lock Warning Switch Assembly
- E 95 Transponder Key Amplifier
- E 96 Transponder Key ECU Assembly
- E 97 Idle Up Switch
- E 106 Junction Connector

Position of Parts in Instrument Panel <RHD Front Bench Seat Type>

E 47
Yellow

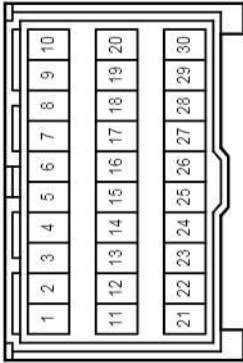

E 48
Black

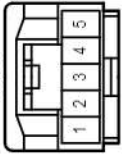

E 53
White



E 58

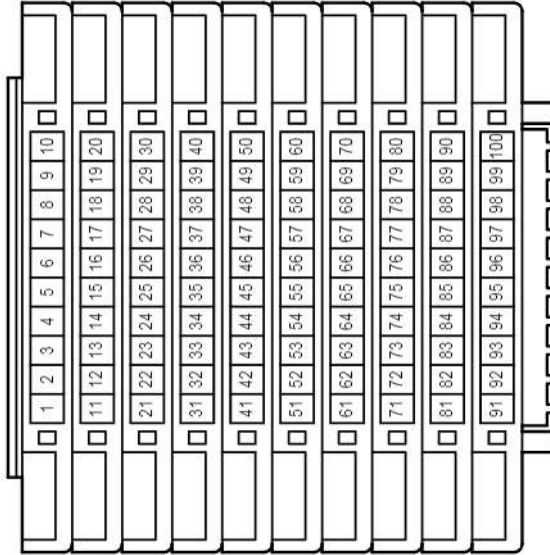

E 59

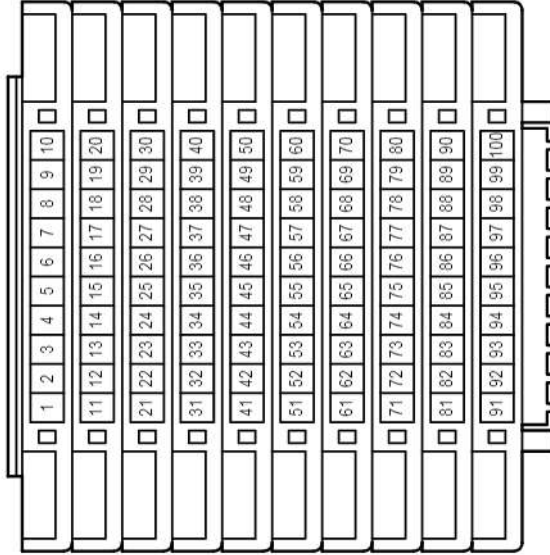

E 60

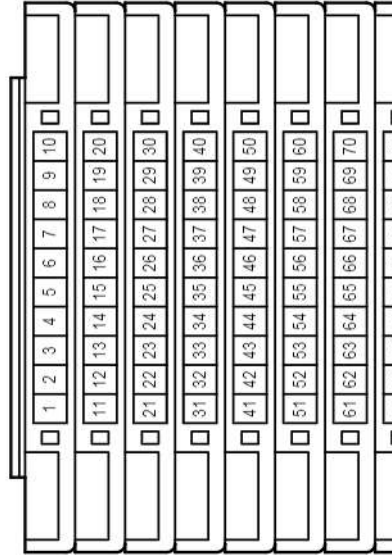

E 61

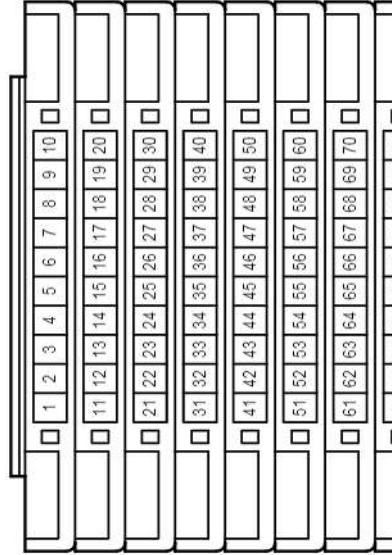

Position of Parts in Instrument Panel <RHD Front Bench Seat Type>

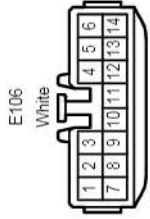
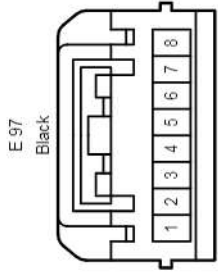
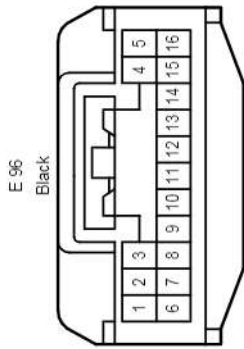

Position of Parts in Instrument Panel <RHD Front Bench Seat Type>

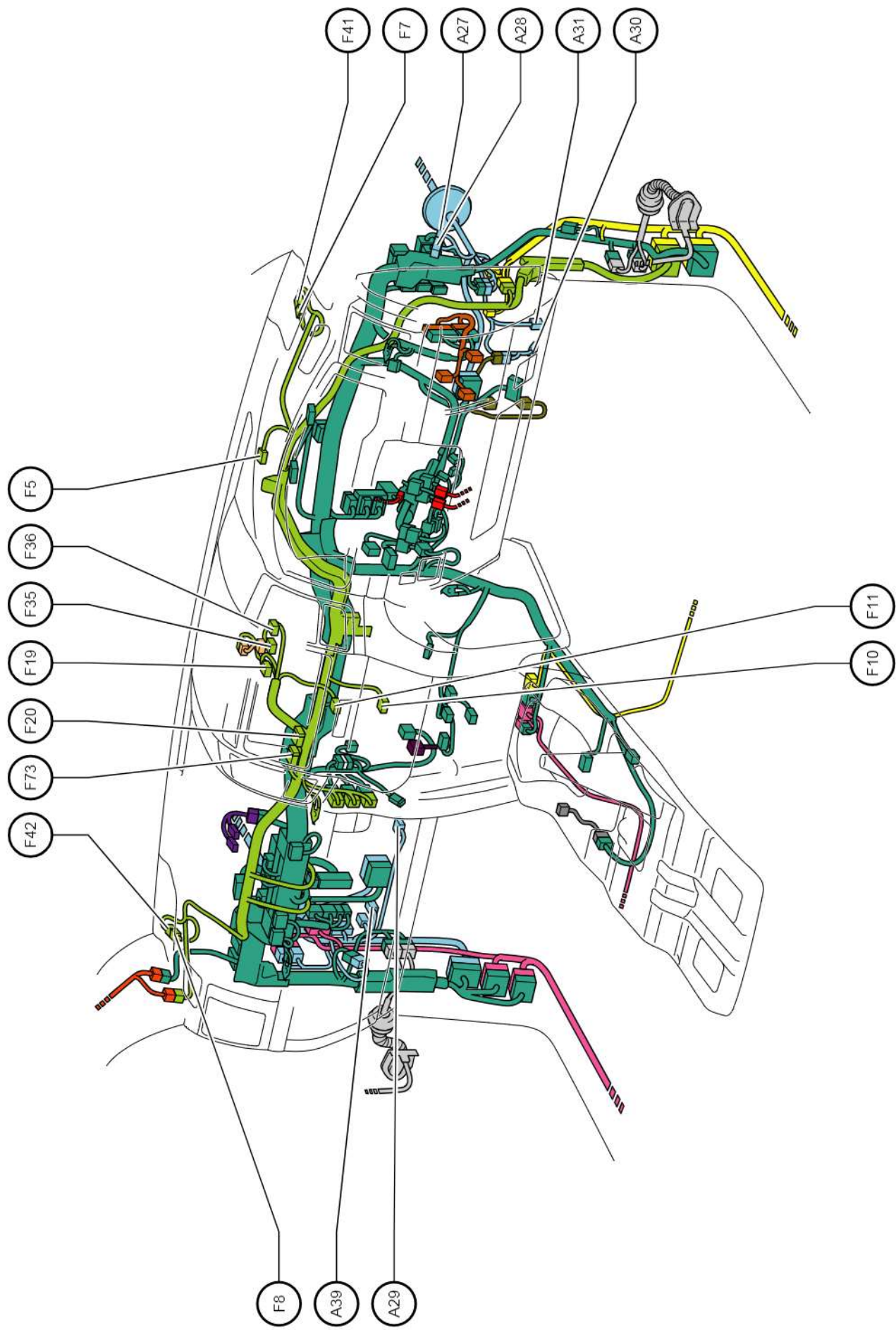

Position of Parts in Instrument Panel <RHD Front Bench Seat Type>

- A 27 Four Wheel Drive Control ECU
- A 28 Four Wheel Drive Control ECU
- A 29 Front Blower with Fan Motor Sub-Assembly
- A 30 Stop Light Switch Assembly
- A 31 Accelerator Pedal Sensor Assembly
- A 39 Stop Light Control Relay Assembly

- F 5 Amplifier Antenna Assembly
- F 7 Front No.2 Speaker Assembly RH , Short Connector
- F 8 Front No.2 Speaker Assembly LH , Short Connector
- F 10 A/C Control Assembly
- F 11 Hazard Warning Signal Switch Assembly
- F 19 Radio Receiver Assembly
- F 20 Junction Connector
- F 35 Radio Receiver Assembly
- F 36 Radio Receiver Assembly
- F 41 Short Connector
- F 42 Short Connector
- F 73 Junction Connector

Position of Parts in Instrument Panel <RHD Front Bench Seat Type>

cardiagn.com

A 27
Black

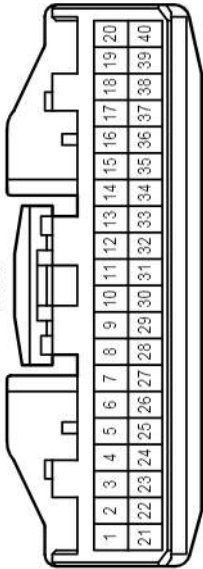

A 28
Black

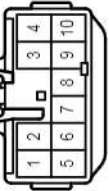

A 29
White

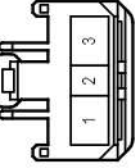

A 30
Gray

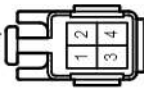

A 31
Black

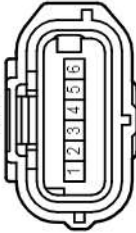

A 39
Black



F 5
White



F 7
White



F 8
White



F 10
White

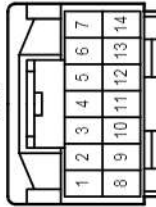

F 11
Gray

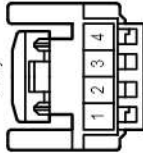

F 19
White

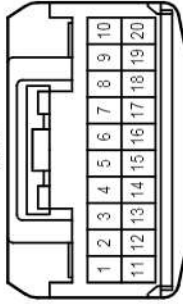

F 20
Gray

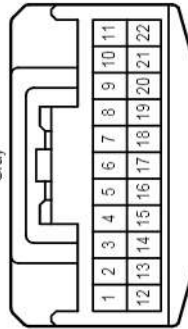

F 35
White

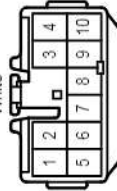

F 36
White

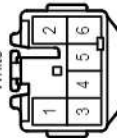

F 42
White

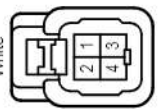

F 73
Blue

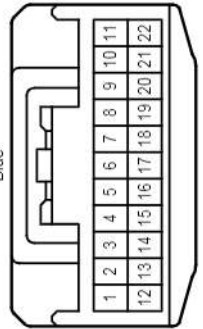

F 41
White

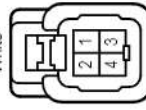

Position of Parts in Instrument Panel <RHD Front Bench Seat Type>

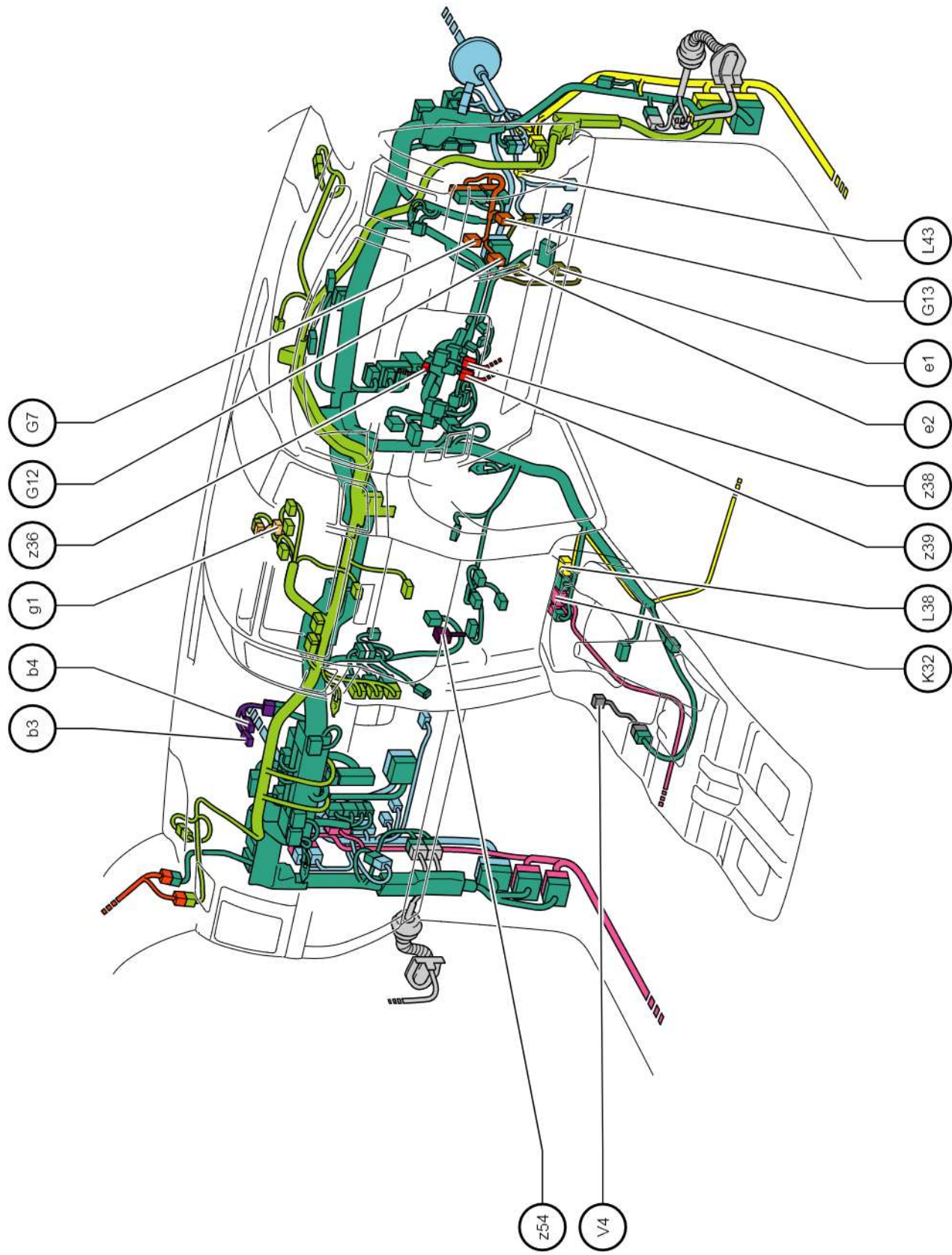

- G 7 Outer Mirror Switch Assembly
- G 12 Center Differential Lock Switch
- G 13 VSC Off Switch
- K 32 Center Airbag Sensor Assembly
- L 38 Center Airbag Sensor Assembly
- L 43 Option Connector (Parking Assist-Sensor)
- V 4 Suspension Control Switch
- b 3 Front Passenger Side Squib Circuit
- b 4 Front Passenger Side Squib Circuit
- e 1 Clutch Start Switch Assembly
- e 2 Clutch Switch Assembly
- g 1 Clock Assembly
- z 36 Spiral Cable Sub-Assembly , Steering Pad Switch
- z 38 Driver Side Squib 2nd Step Circuit , Spiral Cable Sub-Assembly
- z 39 Driver Side Squib Circuit , Spiral Cable Sub-Assembly
- z 54 A/C Amplifier Assembly , A/C Blower Assembly

Position of Parts in Instrument Panel <RHD Front Bench Seat Type>

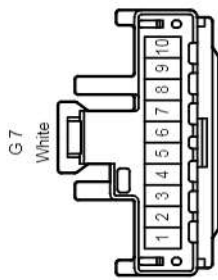

G7
White

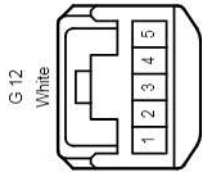

G12
White

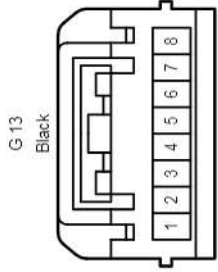

G13
Black

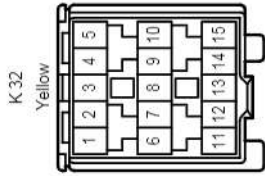

K32
Yellow

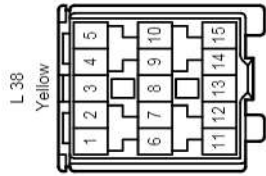

L38
Yellow

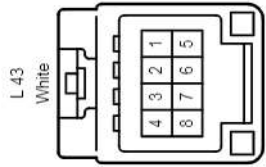

L43
White

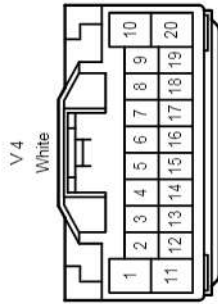

V4
White

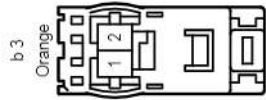

b3
Orange

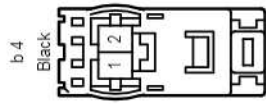

b4
Black

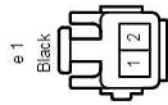

e1
Black



e2
White

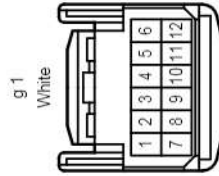

g1
White

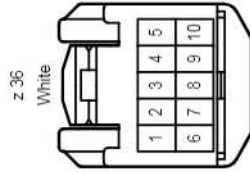

z36
White

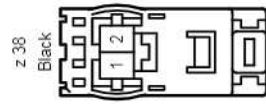

z38
Black

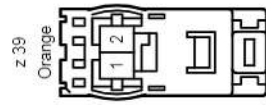

z39
Orange

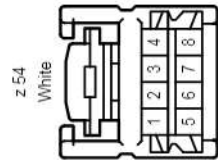

z54
White

Wire and Wire in Instrument Panel <RHD Front Bench Seat Type>

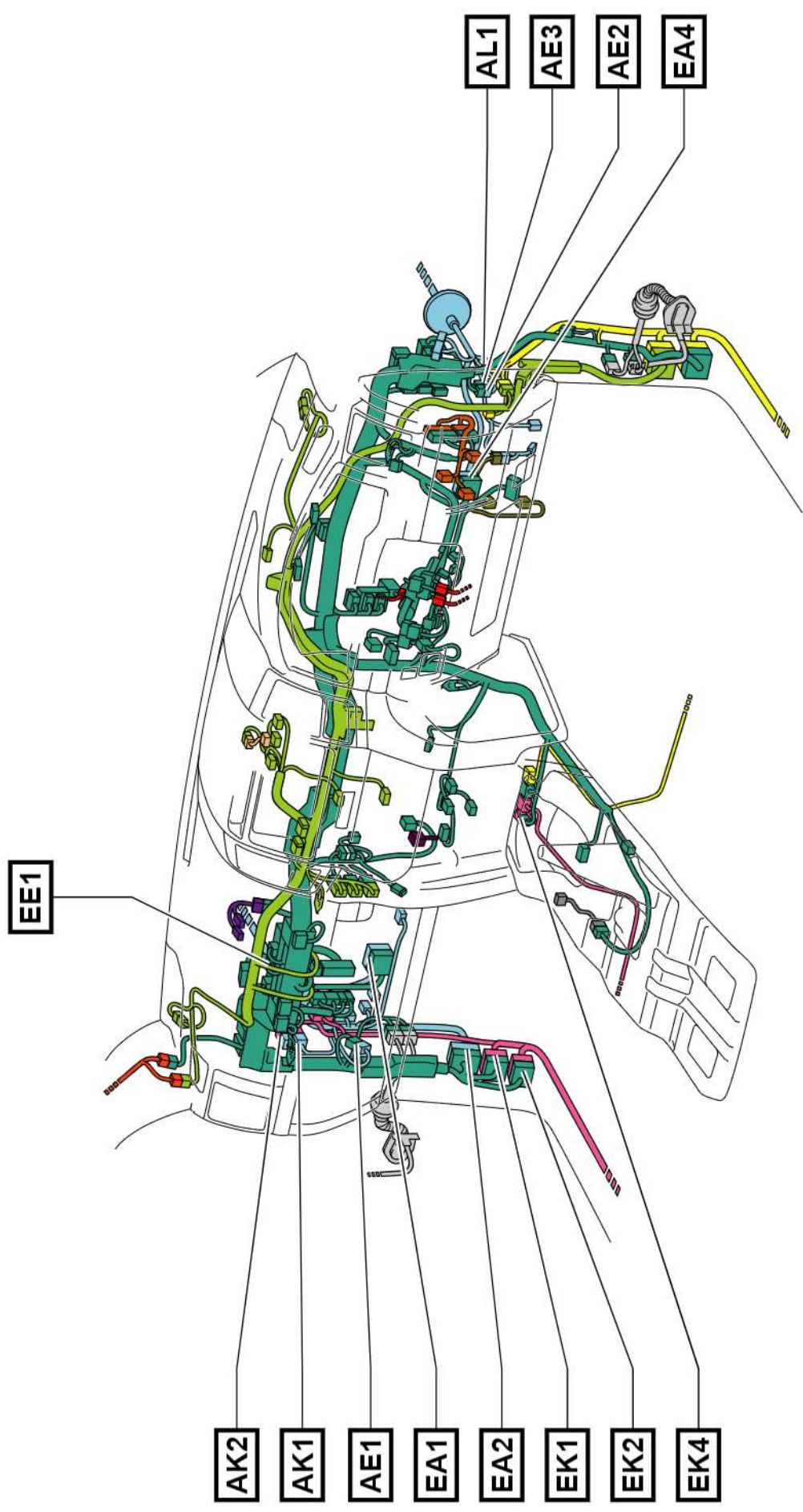

Wire and Wire in Instrument Panel <RHD Front Bench Seat Type>

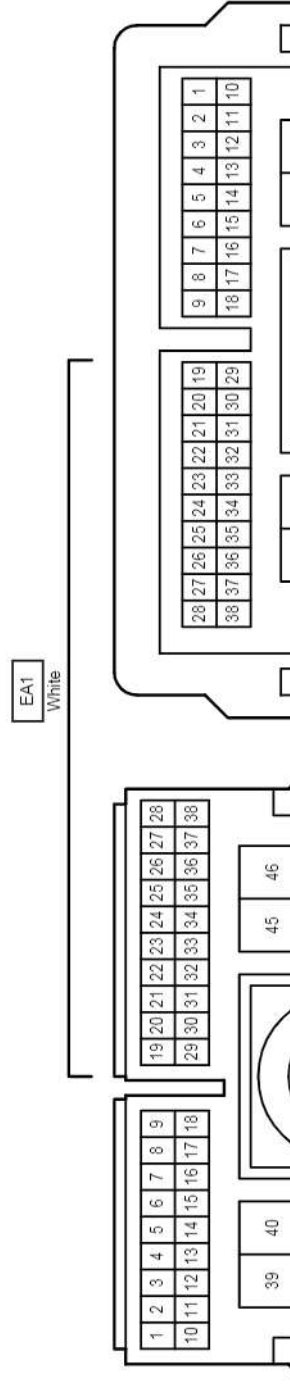
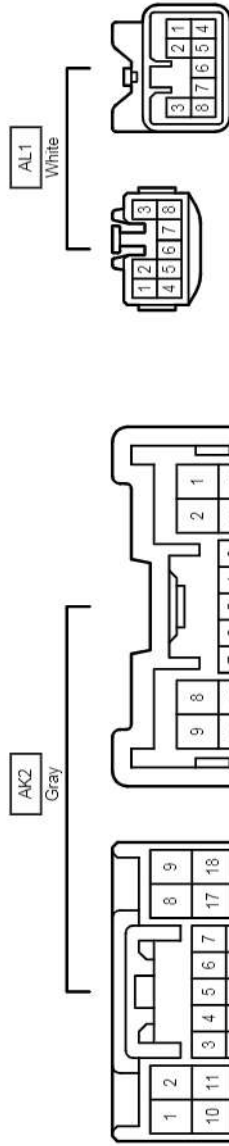
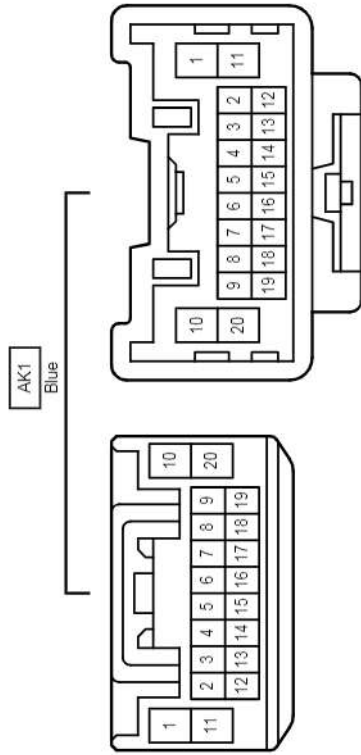
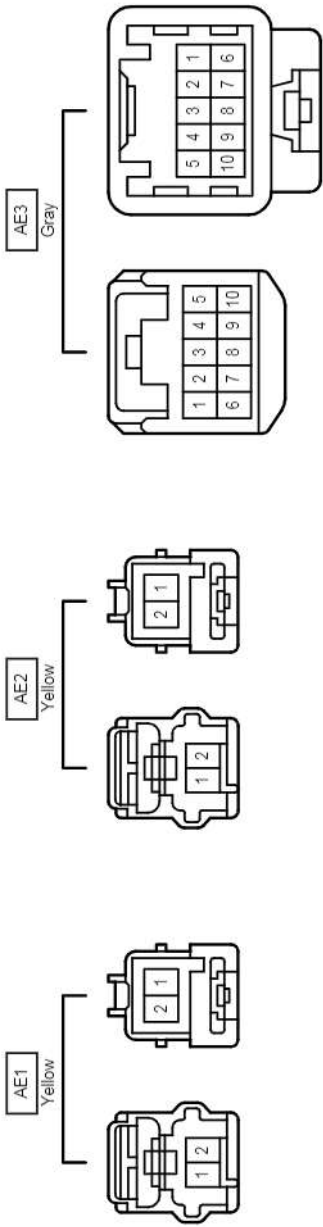

Wire and Wire in Instrument Panel <RHD Front Bench Seat Type>

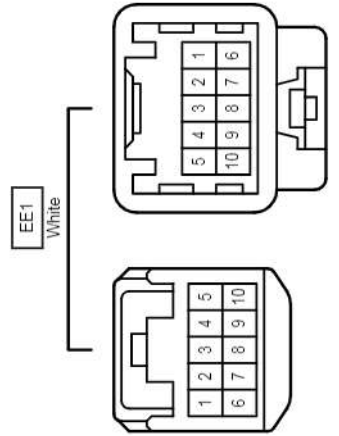
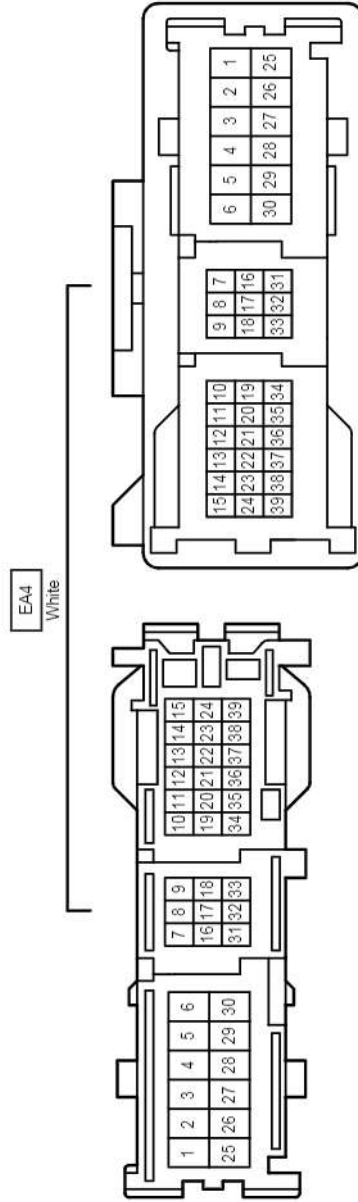
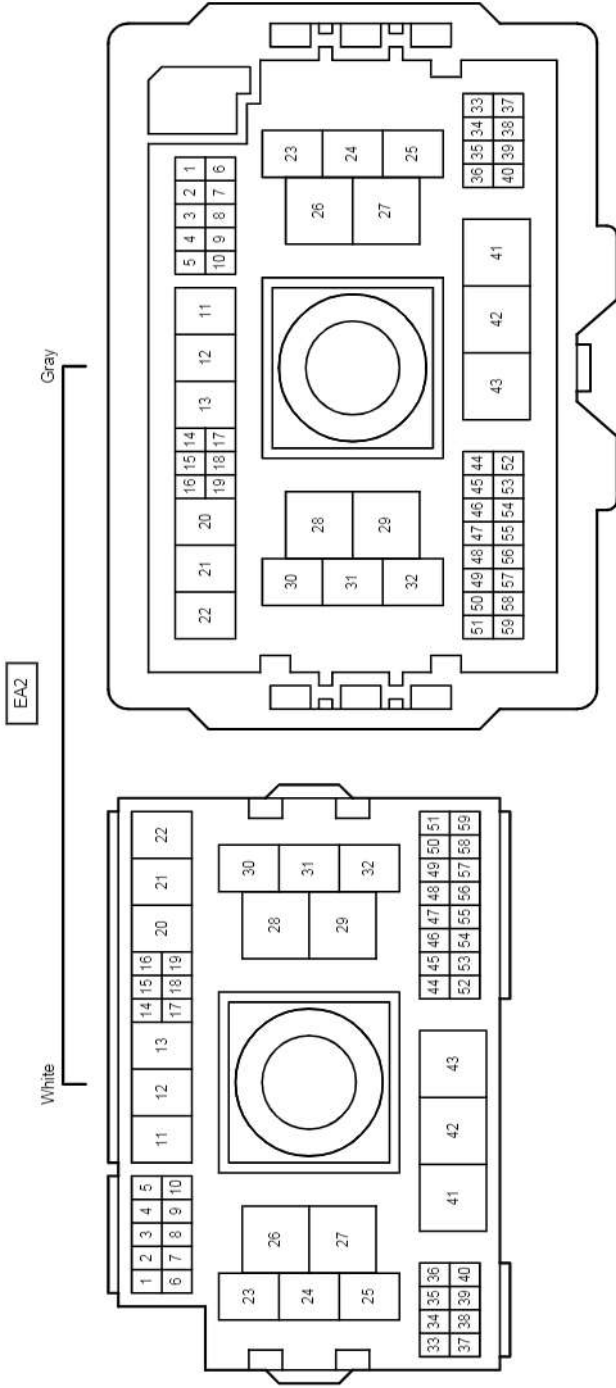

Wire and Wire in Instrument Panel <RHD Front Bench Seat Type>

EK1

Blue

White

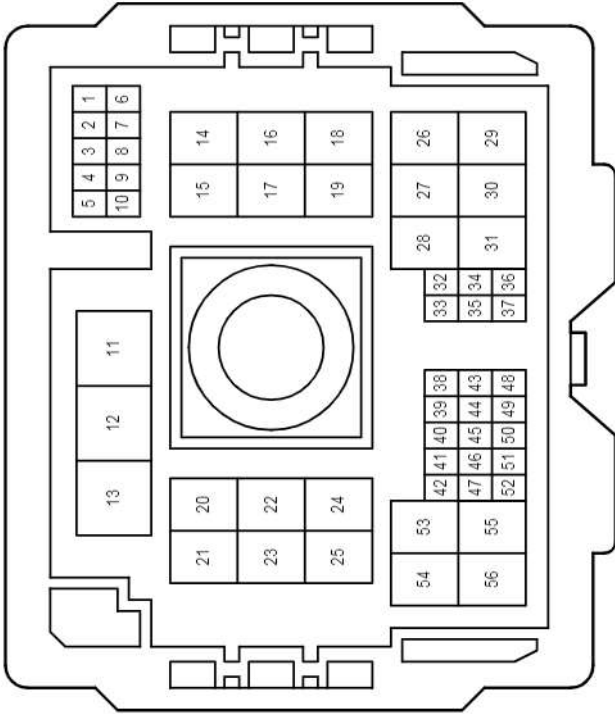

EK2

White

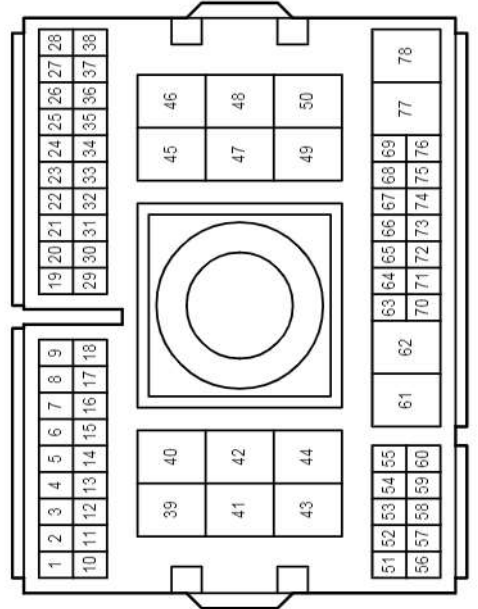
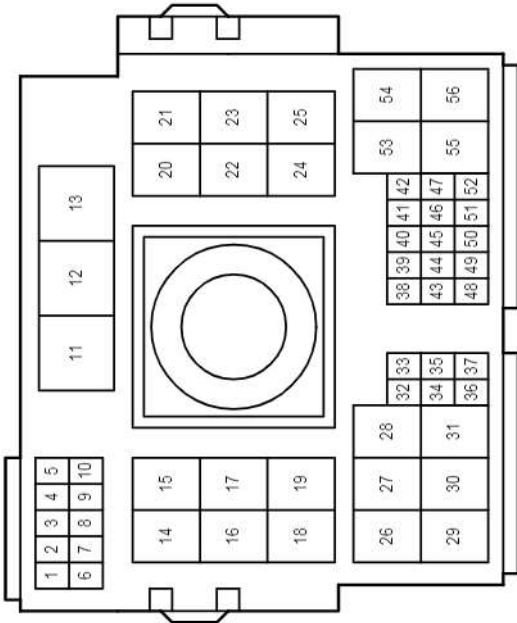
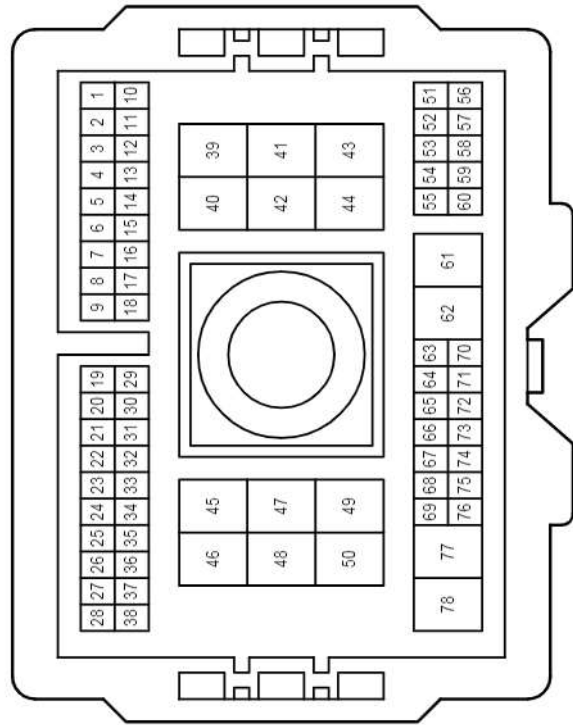

Wire and Wire in Instrument Panel <RHD Front Bench Seat Type>

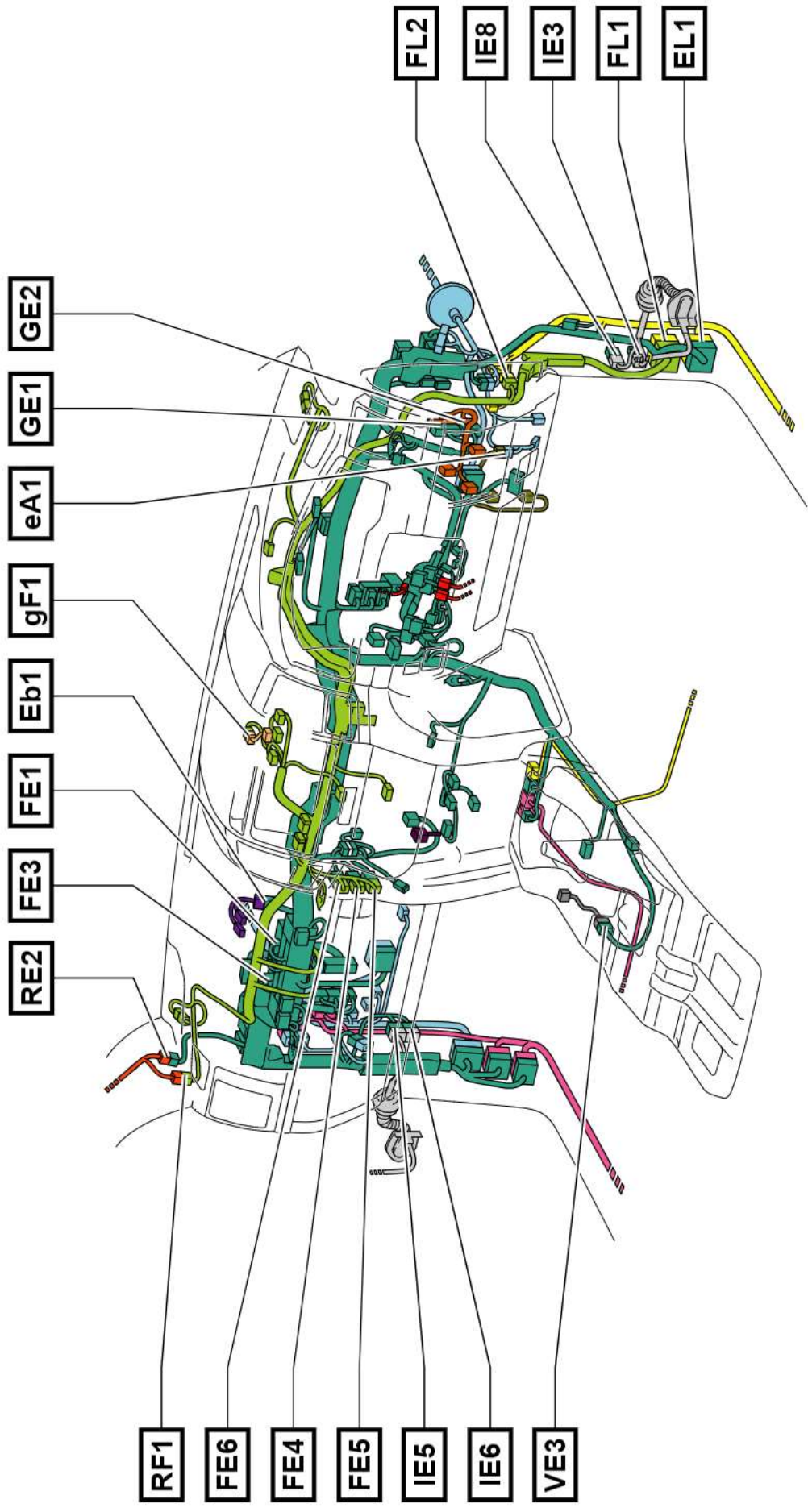

Wire and Wire in Instrument Panel <RHD Front Bench Seat Type>

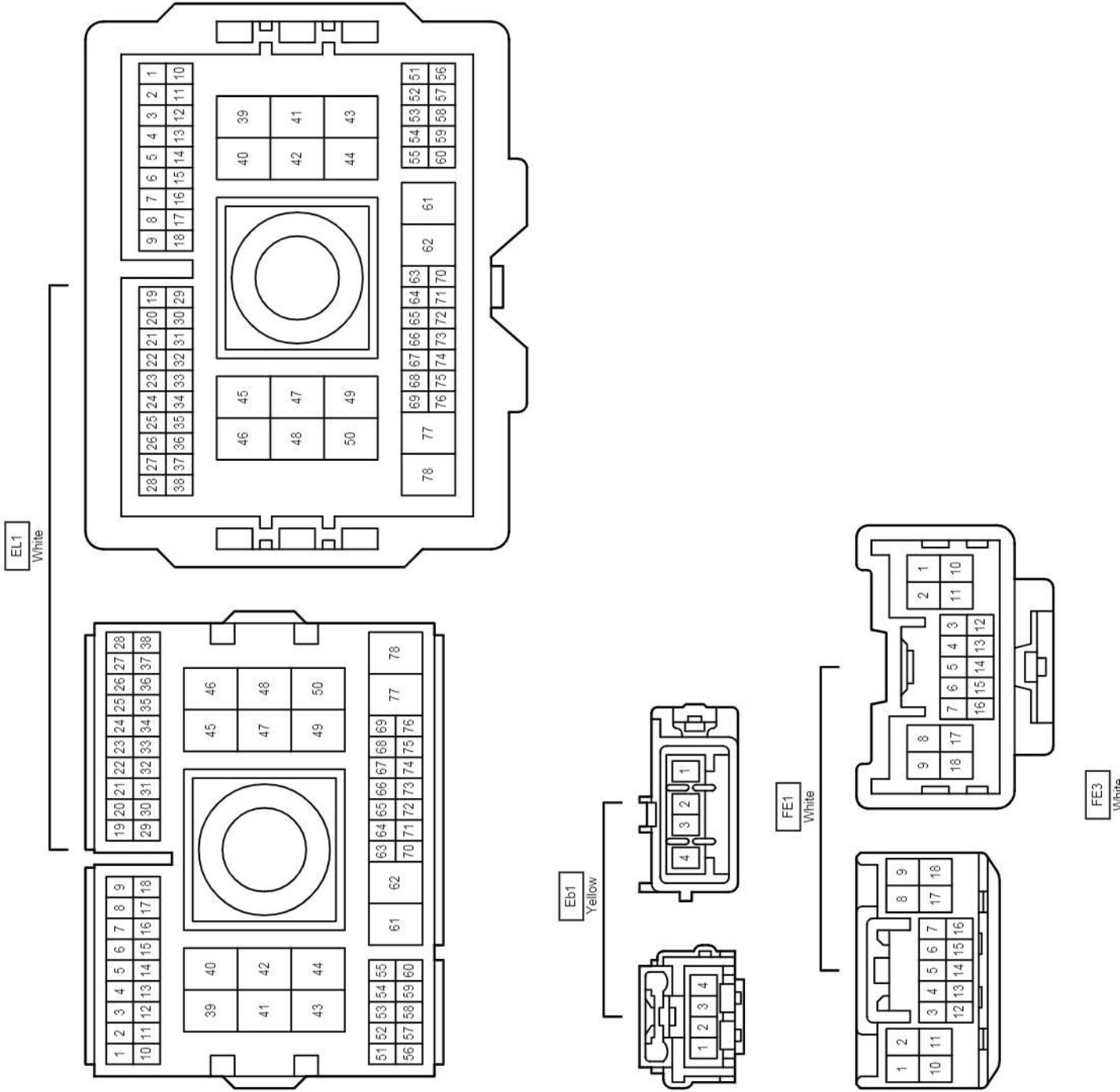

Wire and Wire in Instrument Panel <RHD Front Bench Seat Type>

FE4
White

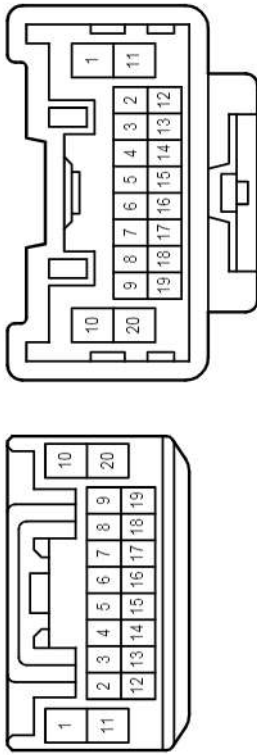

FE5
White

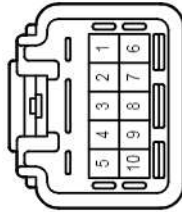
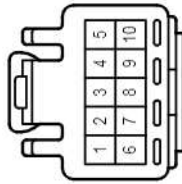

FE6
White

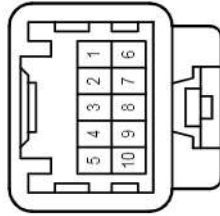
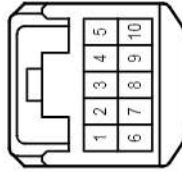

FL1

Blue

White

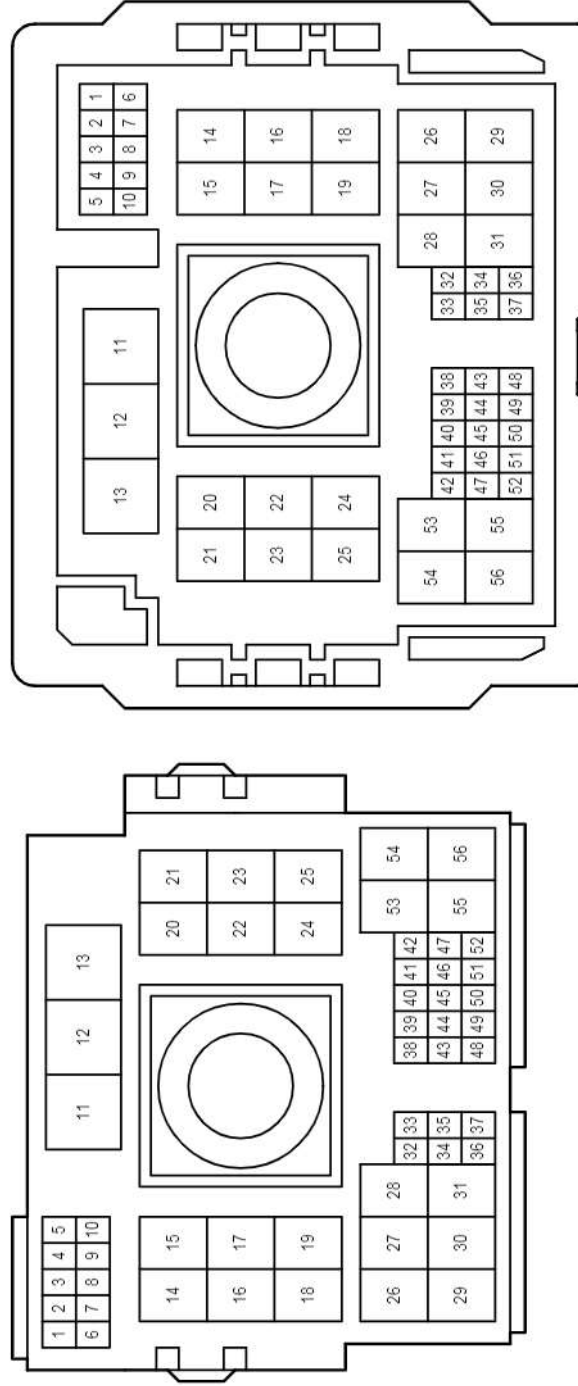

Wire and Wire in Instrument Panel <RHD Front Bench Seat Type>

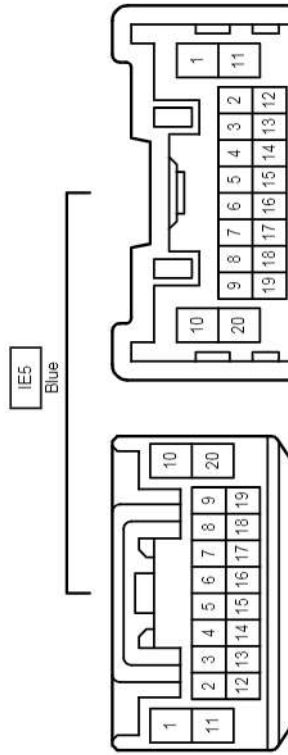
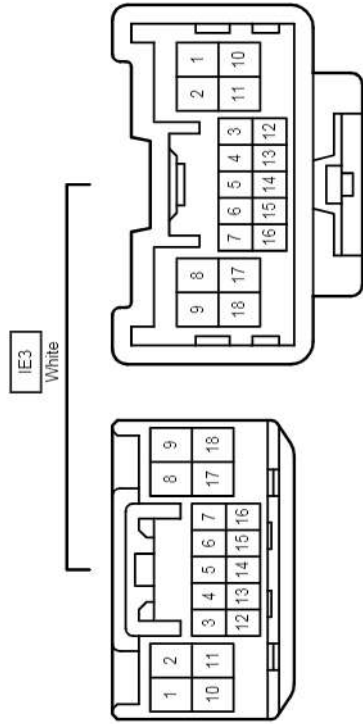
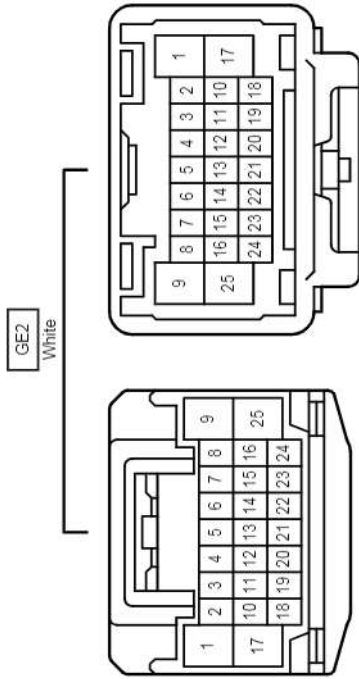
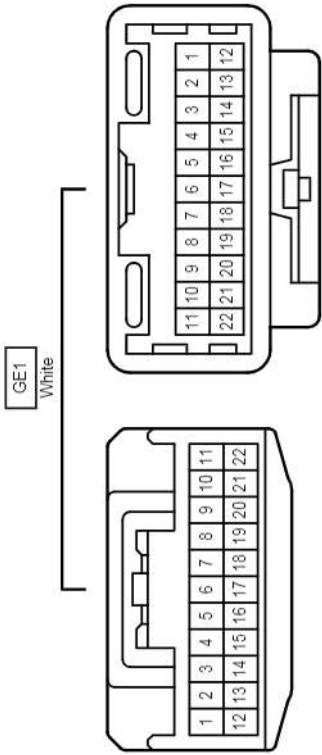

Wire and Wire in Instrument Panel <RHD Front Bench Seat Type>

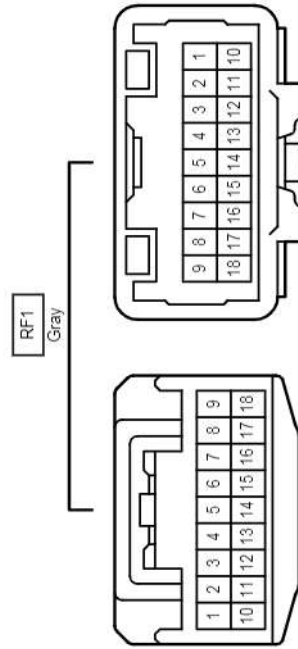
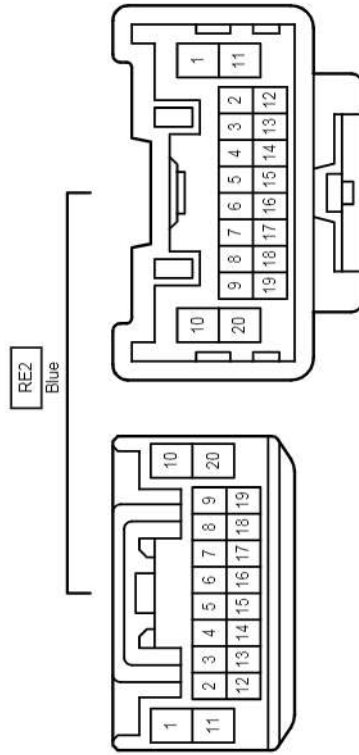
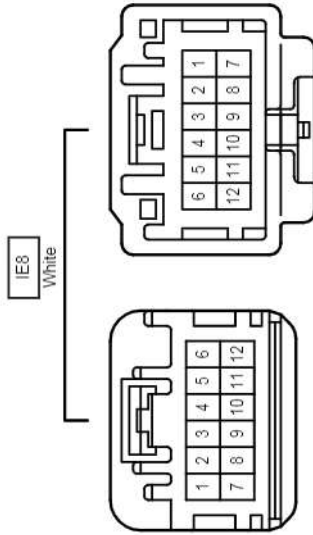
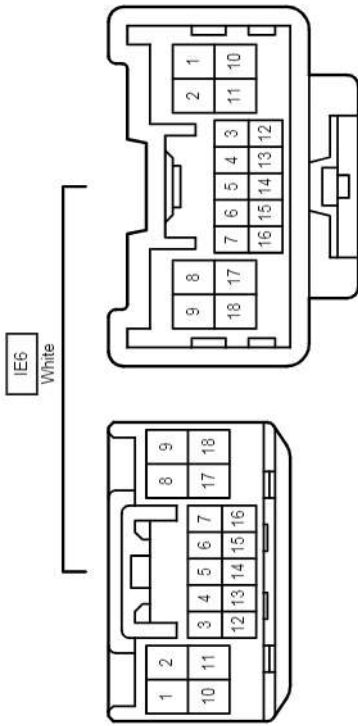

Wire and Wire in Instrument Panel <RHD Front Bench Seat Type>

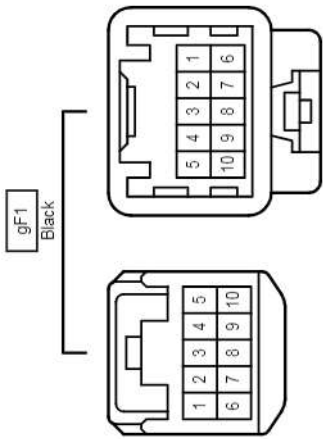

Ground Points in Instrument Panel <LHD Front Separate Seat Type>

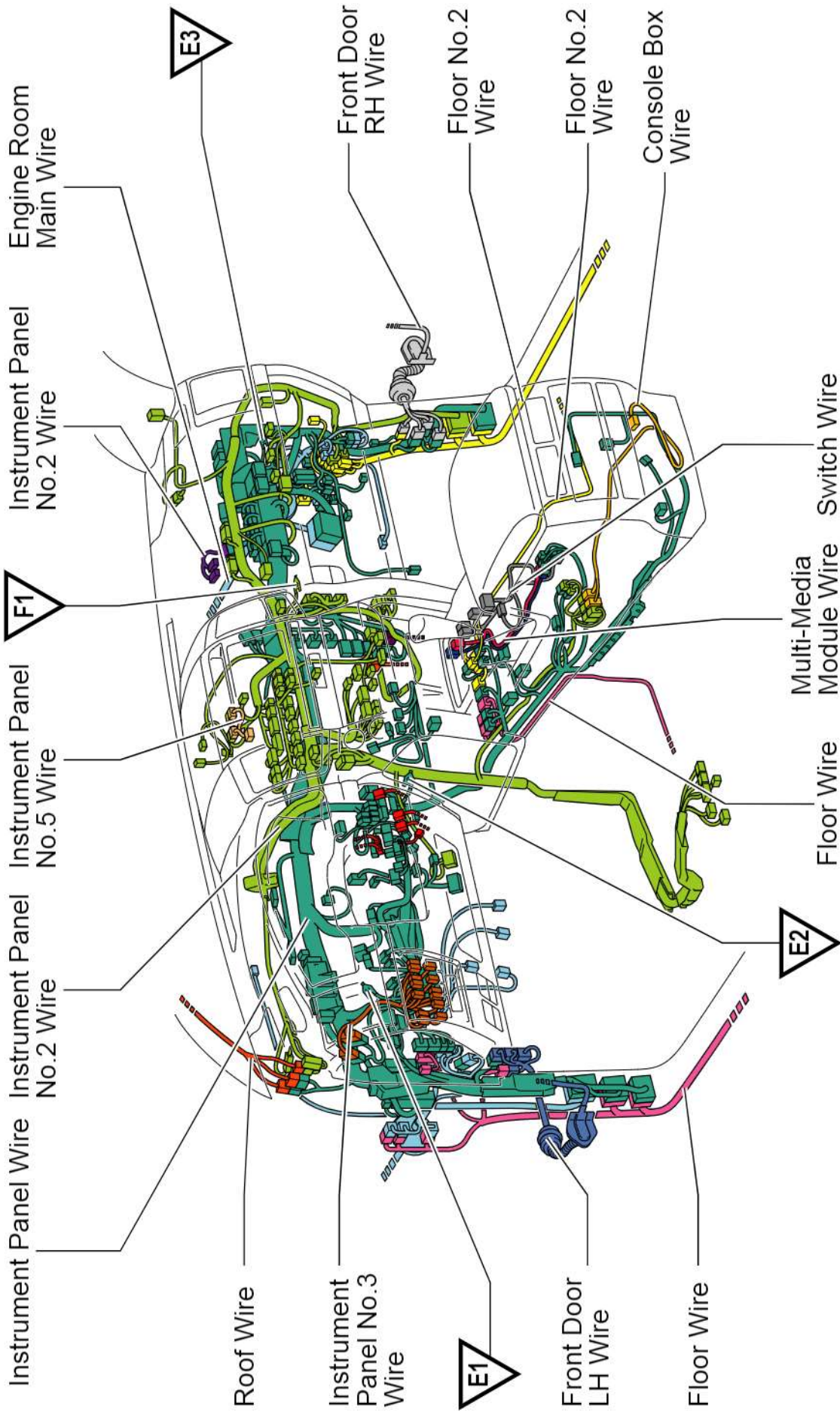

Position of Parts in Instrument Panel <LHD Front Separate Seat Type>

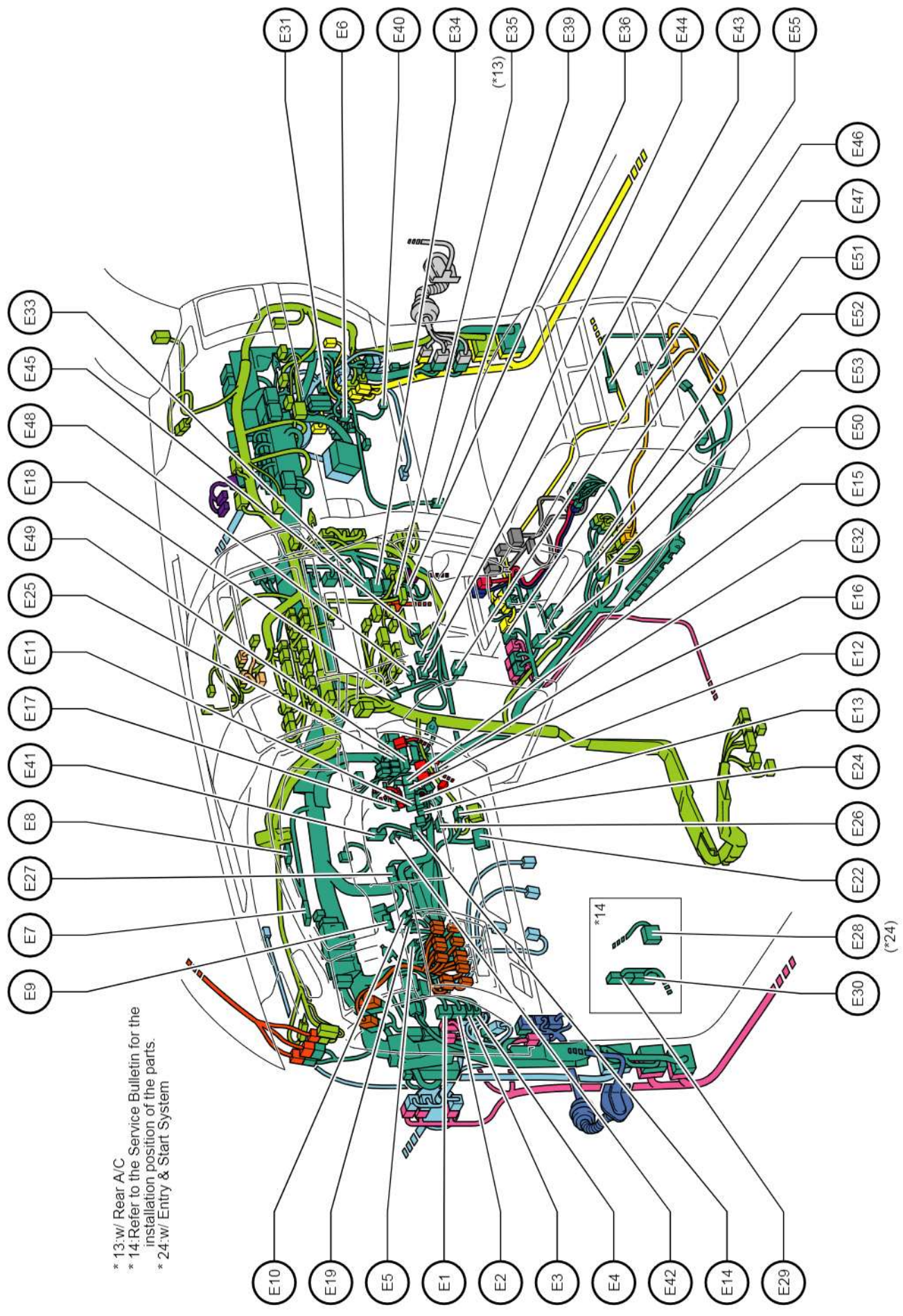

*13:w/ Rear A/C
 *14: Refer to the Service Bulletin for the installation position of the parts.
 *24:w/ Entry & Start System

Position of Parts in Instrument Panel <LHD Front Separate Seat Type>

E 1	Main Body ECU
E 2	Main Body ECU
E 3	Main Body ECU
E 4	Main Body ECU
E 5	Skid Control Buzzer Assembly
E 6	Option Connector (Bus Buffer)
E 7	Combination Meter Assembly
E 8	Combination Meter Assembly
E 9	Light Control Rheostat
E 10	No.1 Clearance Warning Buzzer
E 11	Steering Sensor
E 12	Spiral Cable Sub-Assembly
E 13	Spiral Cable Sub-Assembly
E 14	Headlight Dimmer Switch Assembly
E 15	Windshield Wiper Switch Assembly
E 16	Windshield Wiper Switch Assembly
E 17	Power Tilt Motor
E 18	Engine Switch
E 19	Turn Signal Flasher Assembly
E 22	DLC3
E 24	Lower No.1 Instrument Panel Airbag Assembly
E 25	VSC Off Switch
E 26	Steering Lock Actuator Assembly
E 27	Multiplex Tilt and Telescopic ECU
E 28	ID Code Box
E 29	Certification ECU Assembly
E 30	Certification ECU Assembly
E 31	Network Gateway ECU
E 32	Room Temperature Sensor
E 33	Quick Heater Assembly
E 34	Quick Heater Assembly
E 35	A/C Amplifier Assembly
E 36	A/C Amplifier Assembly
E 39	Glove Box Light Assembly
E 40	Lower No.2 Instrument Panel Airbag Assembly
E 41	Seat Belt Control ECU
E 42	Seat Belt Control ECU
E 43	Cigarette Lighter Assembly
E 44	Cigarette Lighter Illumination Assembly
E 45	Ash Receptacle Light Sub-Assembly
E 46	Front Power Outlet Socket Assembly
E 47	Center Airbag Sensor Assembly
E 48	Transfer Position Switch
E 49	Center Differential Lock Switch

Position of Parts in Instrument Panel <LHD Front Separate Seat Type>

E 1
White

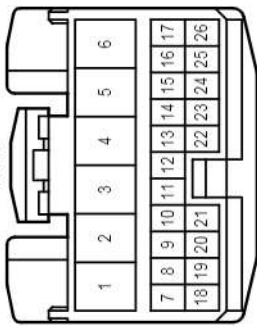

E 2
White

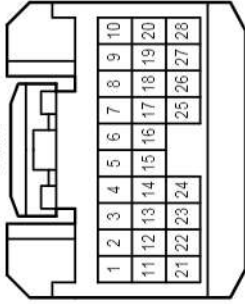

E 3
White

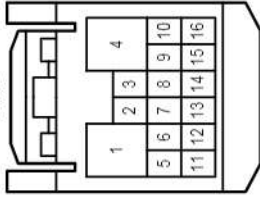

E 4
White

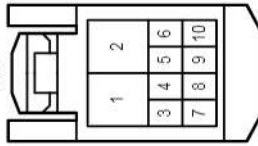

E 5
Blue

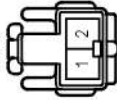

E 6
White

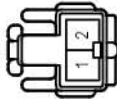

E 7
White

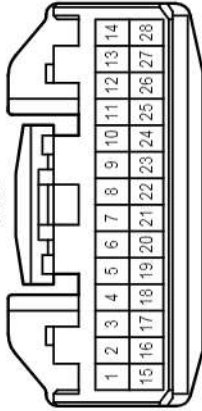

E 8
Black

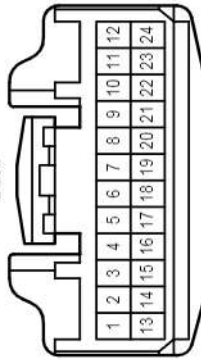

E 9
White

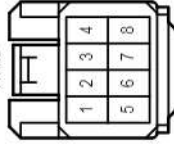

E 10
Black

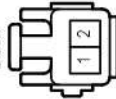

E 11
Gray

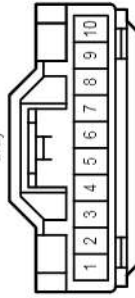

E 12
Black

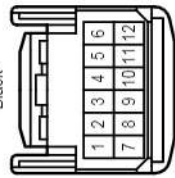

E 13
Yellow

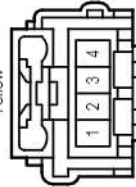

E 14
White

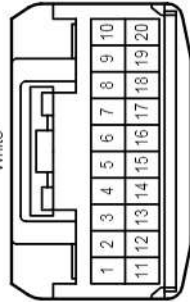

E 15
White

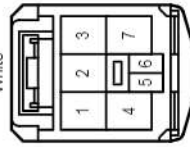

E 16
White



E 17
White



E 18
Black

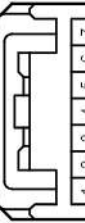

E 19
Black



Position of Parts in Instrument Panel <LHD Front Separate Seat Type>

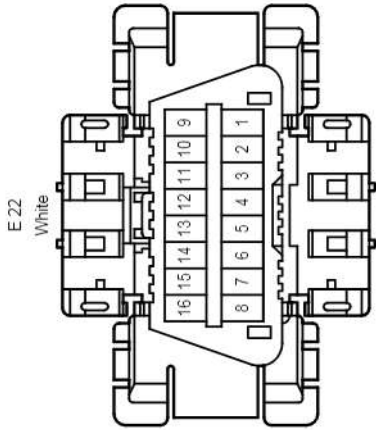

E 22
White

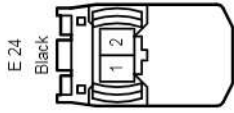

E 24
Black

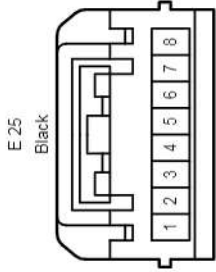

E 25
Black

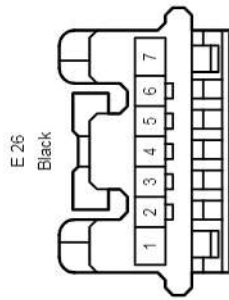

E 26
Black

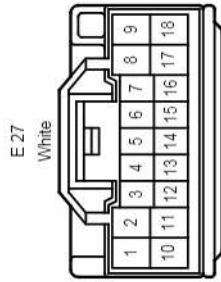

E 27
White

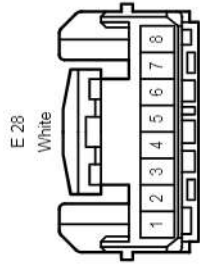

E 28
White

E 29
White

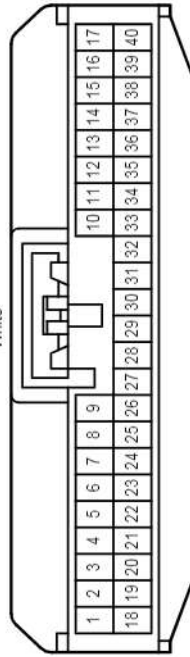

E 30
White

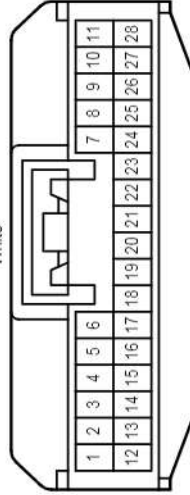

E 31
White

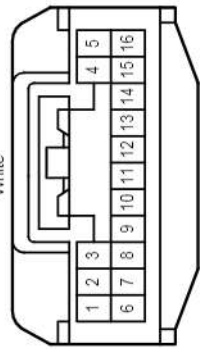

E 32
Black

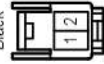

E 33
White

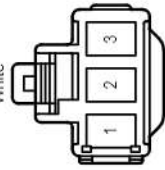

E 34
White

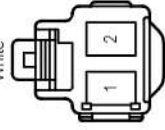

E 35
White

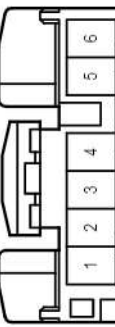

E 36
White

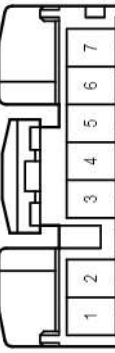

E 39
Black

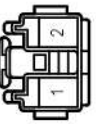

E 40
Black

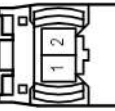

Position of Parts in Instrument Panel <LHD Front Separate Seat Type>

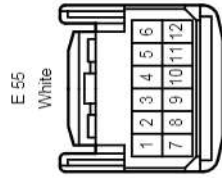
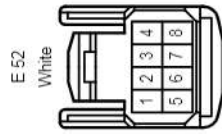
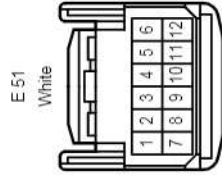
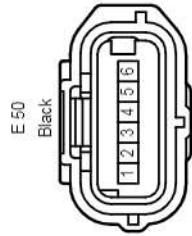
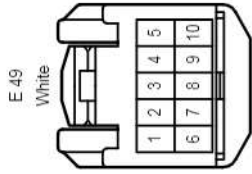
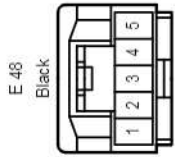
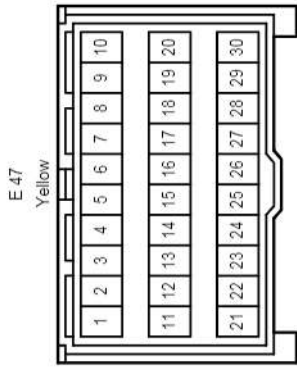
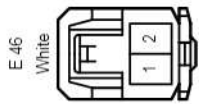

Position of Parts in Instrument Panel <LHD Front Separate Seat Type>

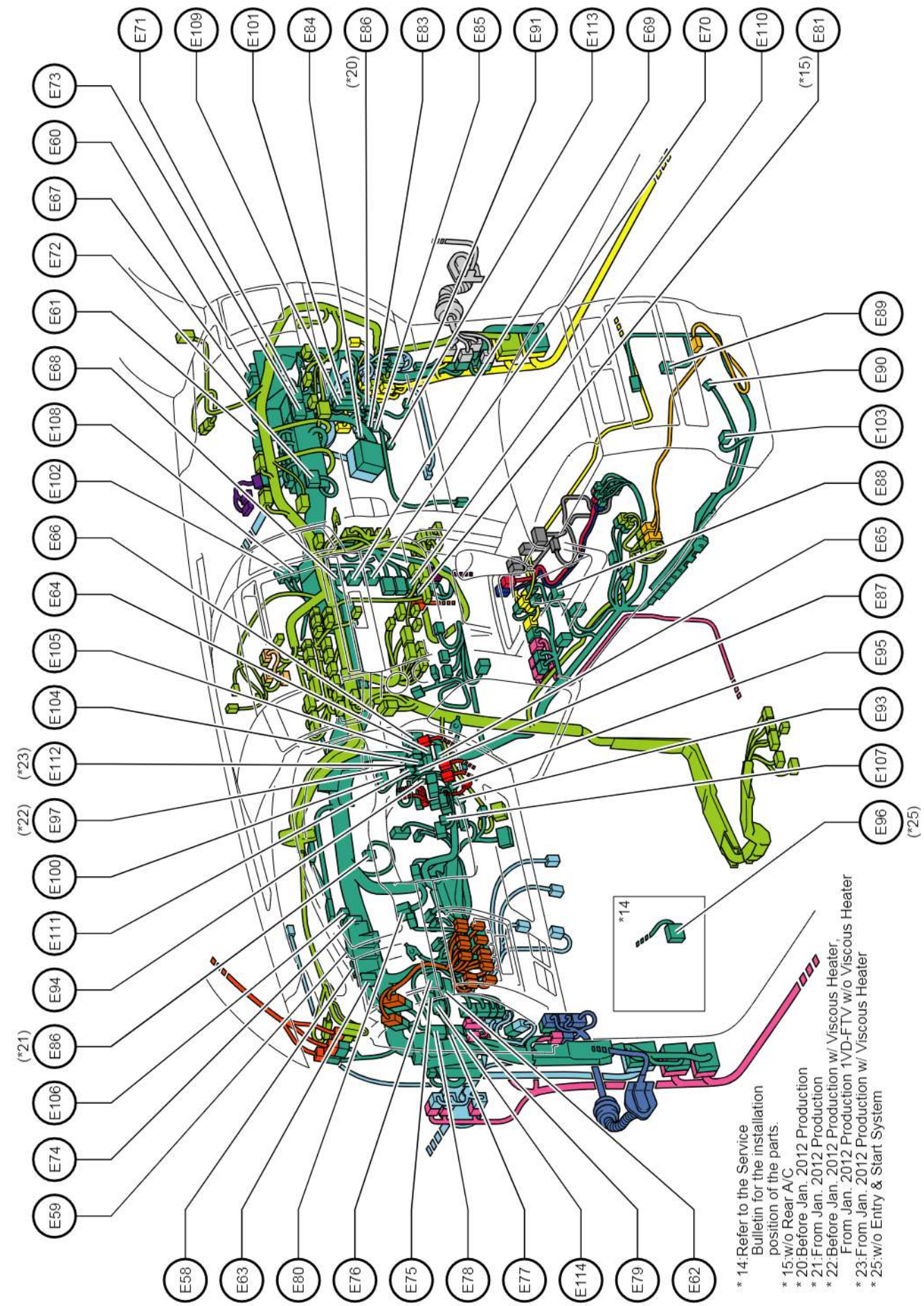

- * 14: Refer to the Service Bulletin for the installation position of the parts.
- * 15: w/o Rear A/C
- * 20: Before Jan. 2012 Production
- * 21: From Jan. 2012 Production
- * 22: Before Jan. 2012 Production w/ Viscous Heater
- * 23: From Jan. 2012 Production 1VD-FTV w/o Viscous Heater
- * 25: From Jan. 2012 Production w/ Viscous Heater
- * 25: w/o Entry & Start System

Position of Parts in Instrument Panel <LHD Front Separate Seat Type>

E 58	Junction Connector
E 59	Junction Connector
E 60	Junction Connector
E 61	Junction Connector
E 62	Junction Connector
E 63	Junction Connector
E 64	Junction Connector
E 65	Junction Connector
E 66	Junction Connector
E 67	Junction Connector
E 68	Junction Connector
E 69	Junction Connector
E 70	Junction Connector
E 71	Junction Connector
E 72	Junction Connector
E 73	Junction Connector
E 74	Junction Connector
E 75	Junction Connector
E 76	Junction Connector
E 77	Steering Control ECU
E 78	Steering Control ECU
E 79	Steering Control ECU
E 80	Steering Actuator Assembly
E 81	A/C Amplifier Assembly
E 83	Windshield Wiper ECU , Short Connector
E 84	Short Connector
E 85	Windshield Wiper ECU
E 86	Double Lock Door Control Relay Assembly
E 87	Differential Lock Switch
E 88	Deceleration Sensor
E 89	Heater Blower Switch
E 90	Cooling Box Assembly
E 91	Option Connector (Parking Assist-Sensor)
E 93	Ignition or Starter Switch Assembly
E 94	Un-Lock Warning Switch Assembly
E 95	Transponder Key Amplifier
E 96	Transponder Key ECU Assembly
E 97	Idle Up Switch
E 100	Main Switch Assembly
E 101	Headlight Leveling ECU Assembly
E 102	Power Steering ECU Assembly
E 103	Rear Power Outlet Socket Assembly
E 104	Back Door Control Switch
E 105	Power Back Door Main Switch

Position of Parts in Instrument Panel <LHD Front Separate Seat Type>

E 58

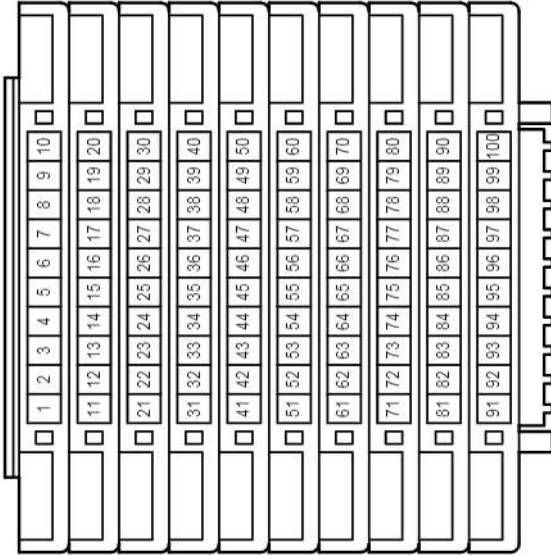

E 59

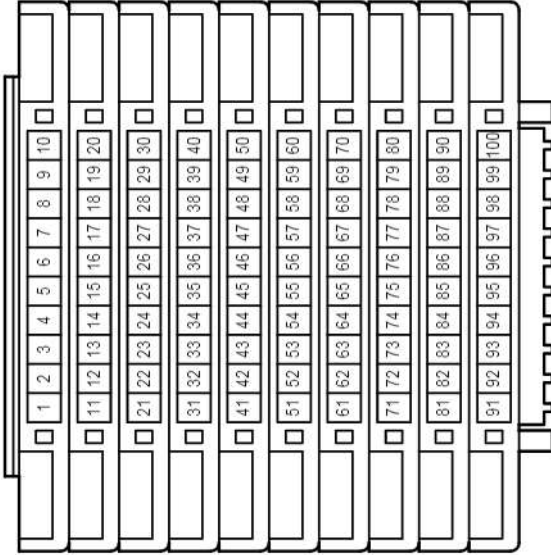

E 60

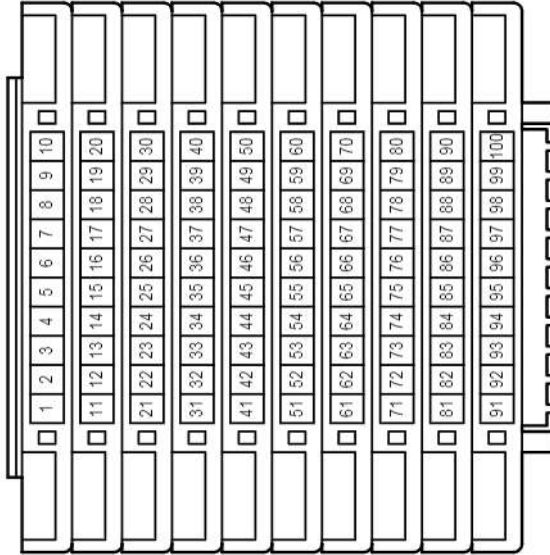

E 61

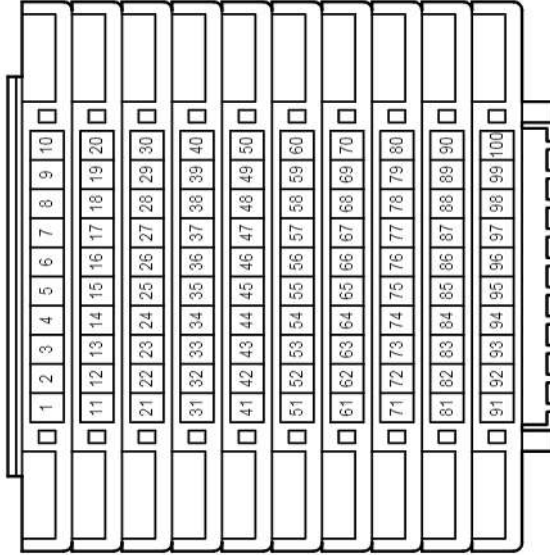

E 62



E 63



E 64

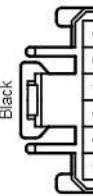

E 65

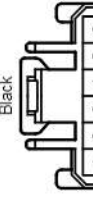

Position of Parts in Instrument Panel <LHD Front Separate Seat Type>

E 69
Gray

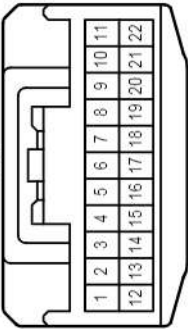

E 70
Gray

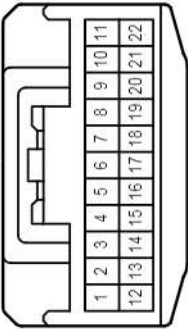

E 71
Gray

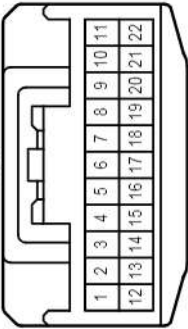

E 72
Gray

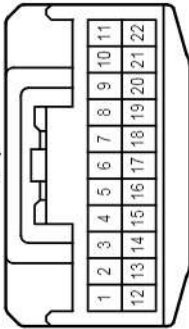

E 73
Gray

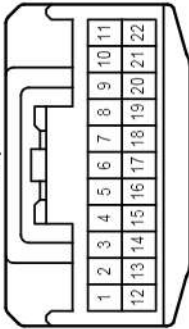

E 74
Gray

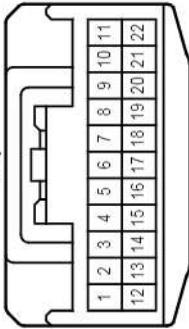

E 75
Gray

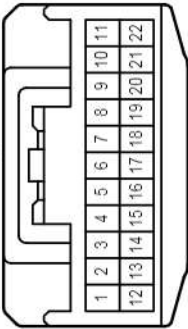

E 76
Gray

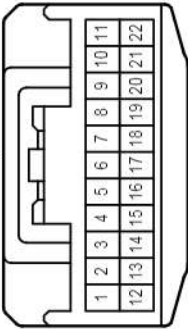

E 77
White

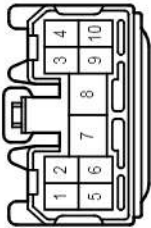

E 78
White

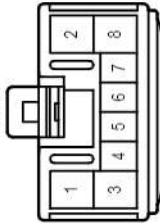

E 79
White

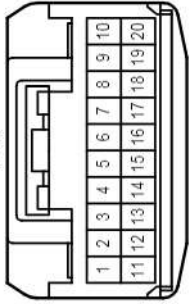

E 80
White

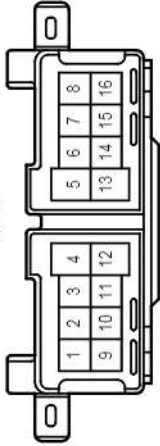

E 81
White

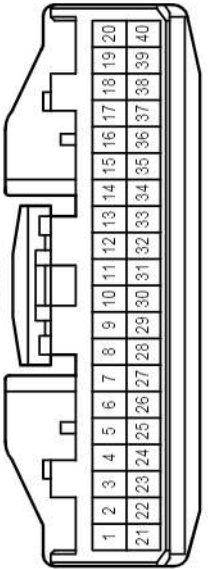

E 83
Blue

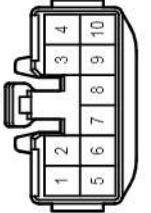

E 84
Blue

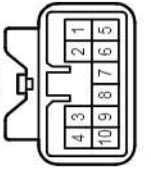

Position of Parts in Instrument Panel <LHD Front Separate Seat Type>

E 89
Black

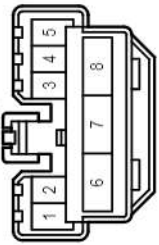

E 90
White

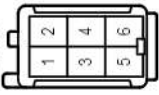

E 91
White

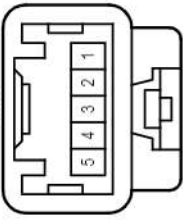

E 93
White

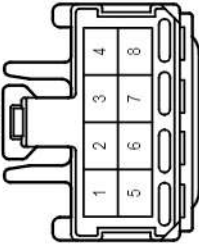

E 94
White



E 95
Black

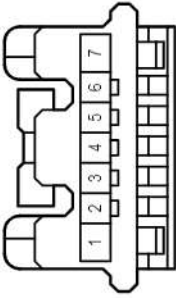

E 96
Black

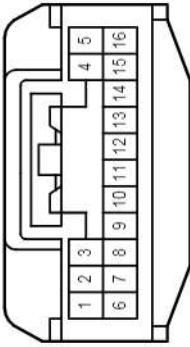

E 97
Black

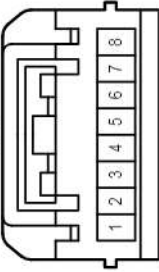

E 100
White



E 101
White

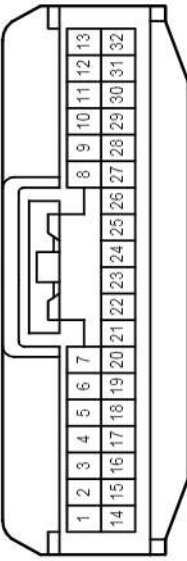

E 102
White

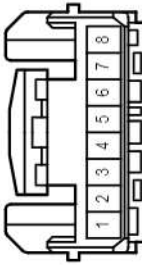

E 103
White

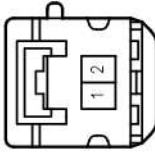

E 104
Black

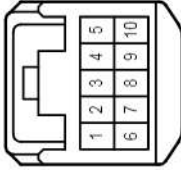

E 105
Black

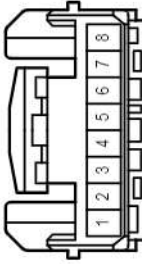

E 106
White

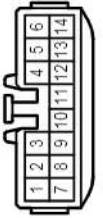

E 107
Black

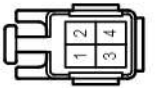

E 108
White

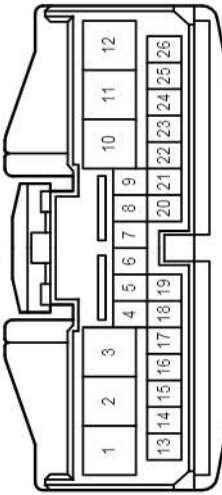

Position of Parts in Instrument Panel <LHD Front Separate Seat Type>

E112
Black

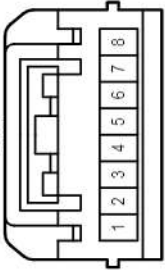

E113
White

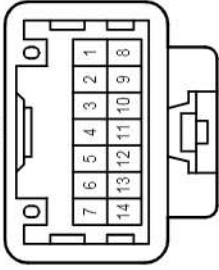

E114
White

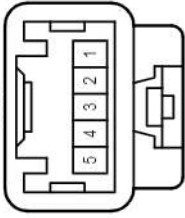

Position of Parts in Instrument Panel <LHD Front Separate Seat Type>

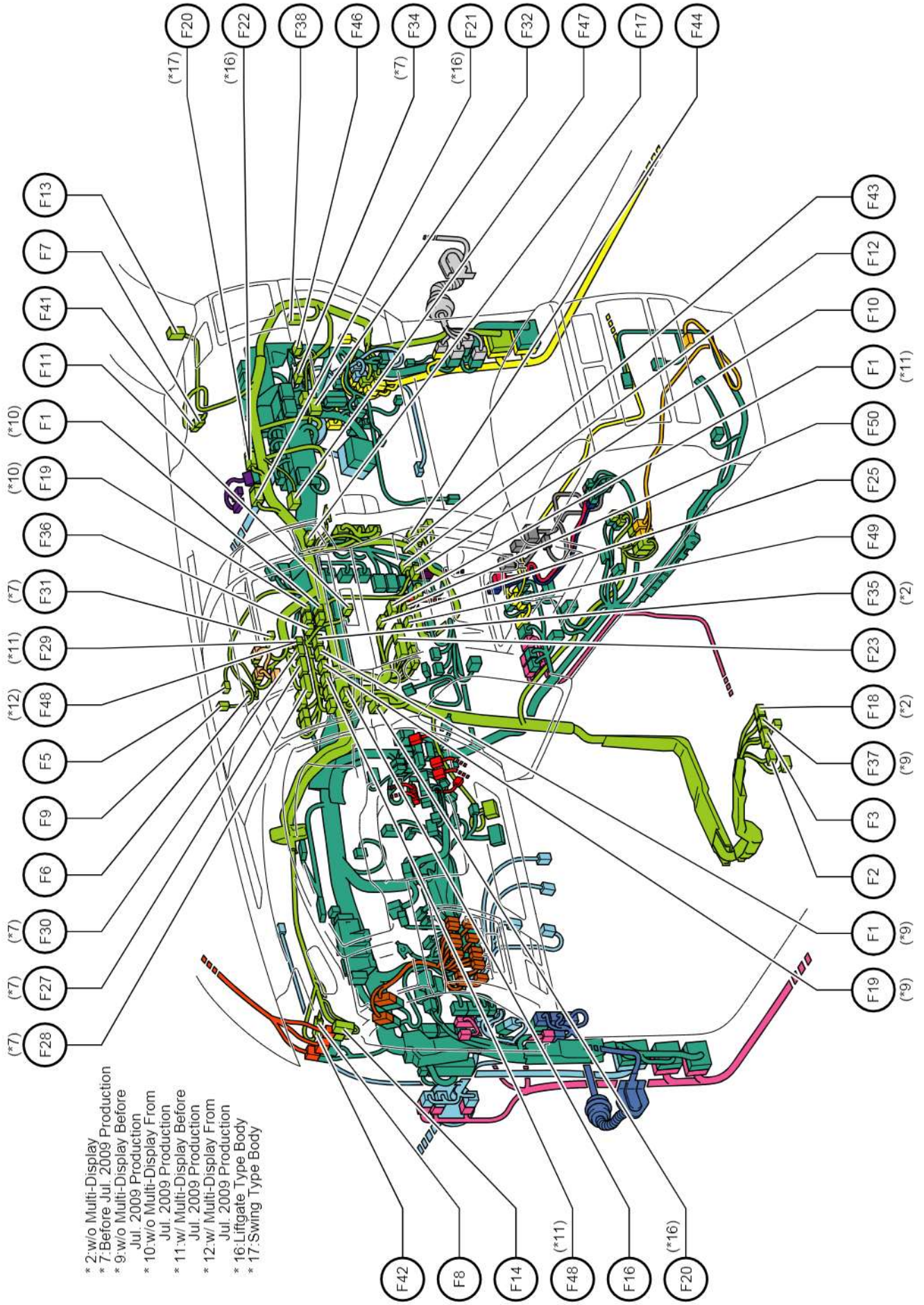

- * 2:w/o Multi-Display
- * 7:Before Jul. 2009 Production
- * 9:w/o Multi-Display Before Jul. 2009 Production
- * 10:w/o Multi-Display From Jul. 2009 Production
- * 11:w Multi-Display Before Jul. 2009 Production
- * 12:w Multi-Display From Jul. 2009 Production
- * 16:Lifgate Type Body
- * 17:Swing Type Body

Position of Parts in Instrument Panel <LHD Front Separate Seat Type>

F 1	Radio Receiver Assembly
F 2	Stereo Component Amplifier Assembly
F 3	Stereo Component Amplifier Assembly
F 5	Amplifier Antenna Assembly
F 6	Front No.4 Speaker Assembly
F 7	Front No.2 Speaker Assembly RH , Short Connector
F 8	Front No.2 Speaker Assembly LH , Short Connector
F 9	Automatic Light Control Sensor
F 10	A/C Control Assembly
F 11	Hazard Warning Signal Switch Assembly
F 12	Clearance Warning ECU Assembly
F 12	Clearance Warning ECU Assembly
F 13	Front No.3 Speaker Assembly RH
F 14	Front No.3 Speaker Assembly LH
F 16	Temperature Control Switch Assembly LH
F 17	Temperature Control Switch Assembly RH
F 18	Stereo Component Amplifier Assembly
F 19	Radio Receiver Assembly
F 20	Junction Connector
F 21	Junction Connector
F 22	Junction Connector
F 23	Radio Receiver Assembly
F 25	Radio Receiver Assembly
F 27	Multi-Display
F 28	Multi-Display
F 29	Multi-Display
F 30	Multi-Display
F 31	Multi-Display
F 32	Navigation ECU
F 34	Navigation ECU
F 35	Radio Receiver Assembly
F 36	Radio Receiver Assembly
F 37	Stereo Component Amplifier Assembly
F 38	Airbag Cut Off Switch Cylinder Sub-Assembly
F 41	Short Connector
F 42	Short Connector
F 43	Parking Assist ECU
F 44	Parking Assist ECU
F 46	Navigation ECU
F 47	Navigation Antenna Assembly
F 48	Multi-Display
F 49	Parking Assist ECU
F 50	Parking Assist ECU

Position of Parts in Instrument Panel <LHD Front Separate Seat Type>

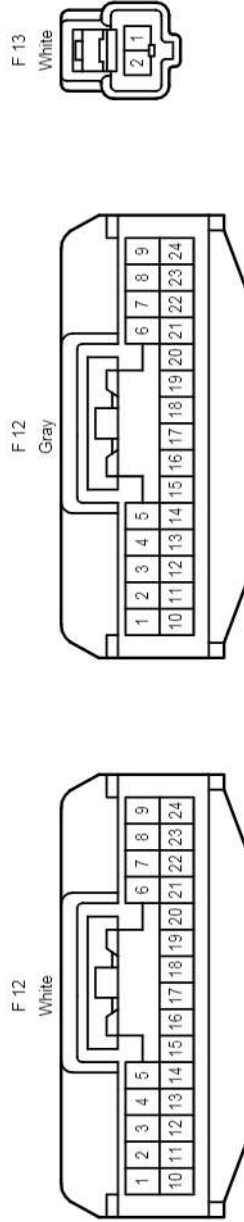
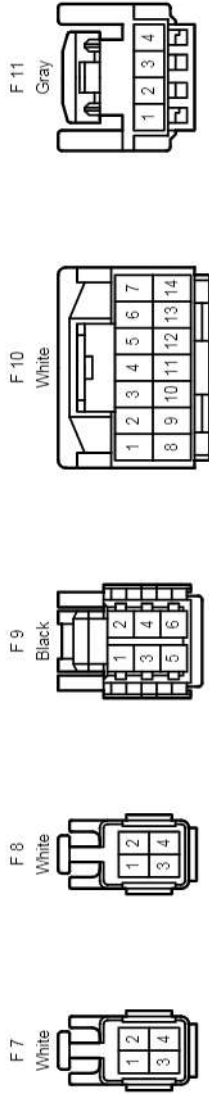
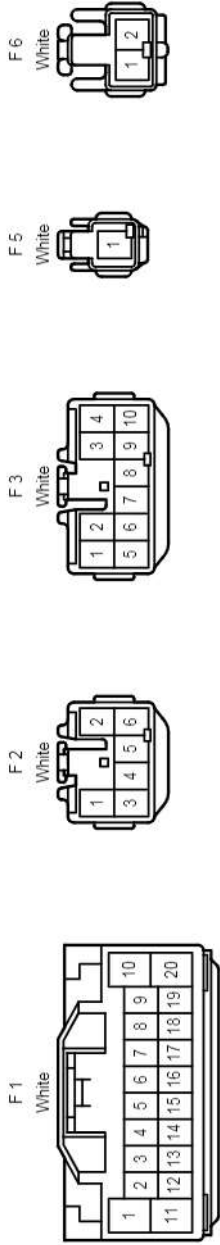

(Before Aug. 2007 Production)

(From Aug. 2007 Production)

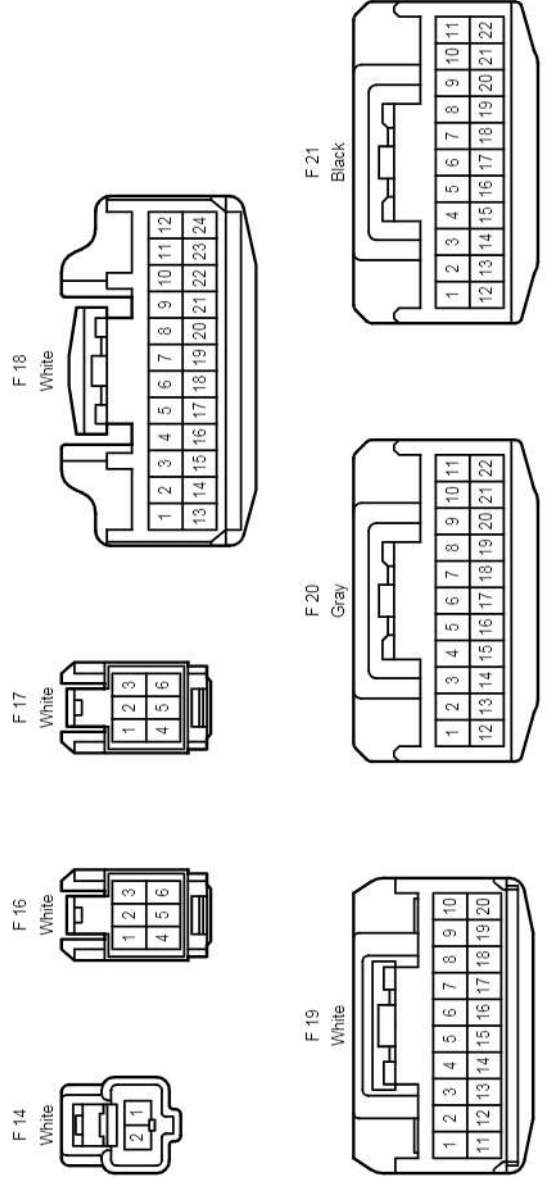

F 22

F 23

F 25

Position of Parts in Instrument Panel <LHD Front Separate Seat Type>

F 27
White

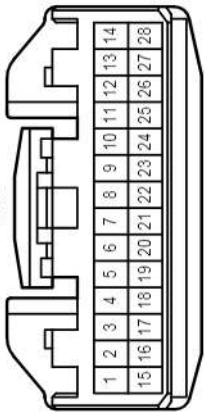

F 28
White

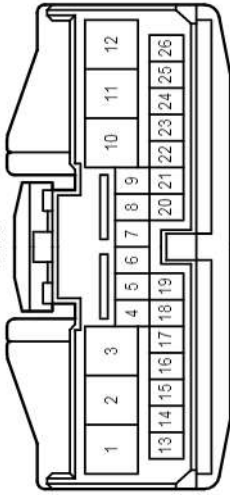

F 29
Blue

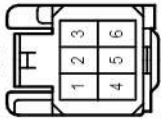

F 30
White

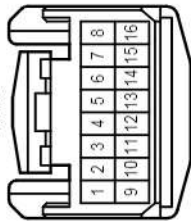

F 31
White

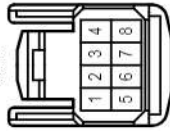

F 32
White

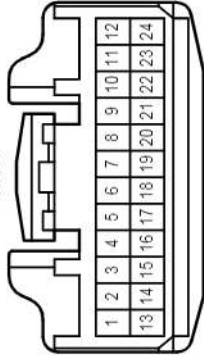

F 34
White

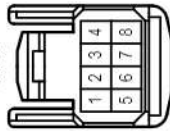

F 35
White

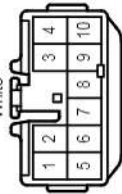

F 36
White

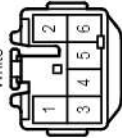

F 37
White

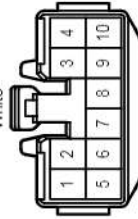

F 38
White



F 41
White

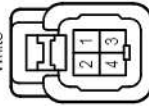

F 42
White

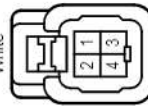

F 43
White

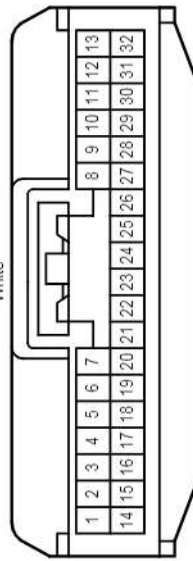

F 44
White

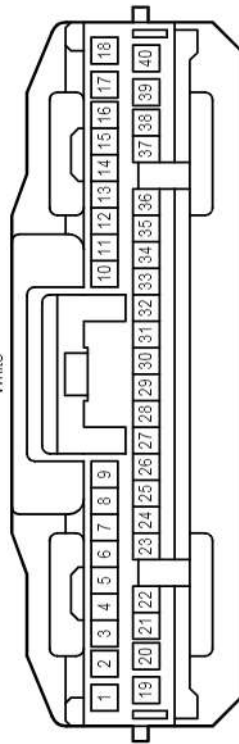

F 46
Gray

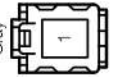

F 47
Gray

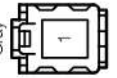

Position of Parts in Instrument Panel <LHD Front Separate Seat Type>

- * 1:w/ Multi-Display
- * 7:Before Jul. 2009 Production
- * 8:From Jul. 2009 Production
- * 10:w/o Multi-Display From Jul. 2009 Production
- * 17: Swing Type Body
- * 26:w/ Multi-Display From Jul. 2009 Production until Jan. 2012 Production
- * 27:w/ Multi-Display From Jan. 2012 Production

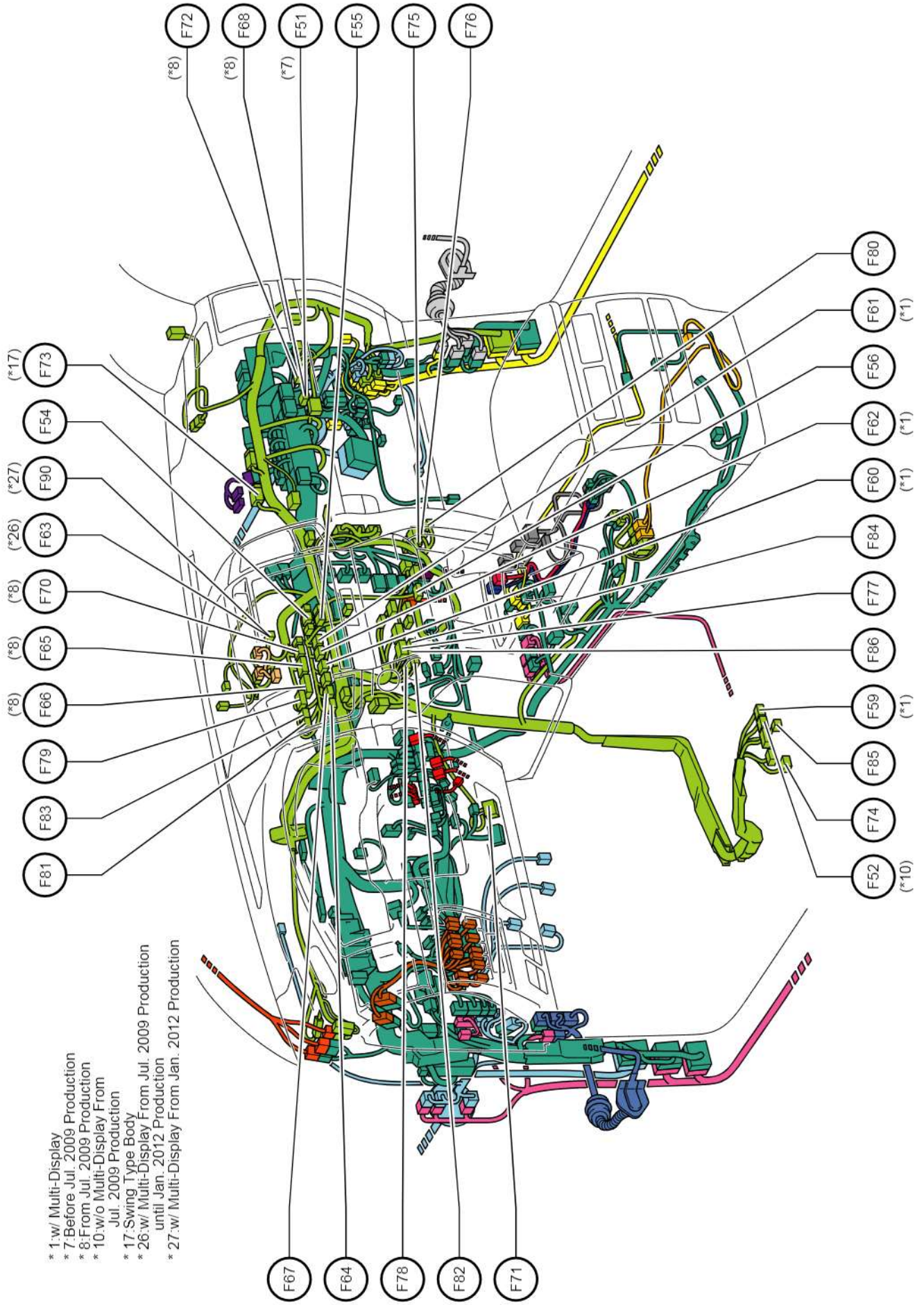

Position of Parts in Instrument Panel <LHD Front Separate Seat Type>

- F 51 Navigation ECU
- F 52 Stereo Component Amplifier Assembly
- F 54 Radio Receiver Assembly
- F 55 Radio Receiver Assembly
- F 56 Radio Receiver Assembly
- F 59 Stereo Component Amplifier Assembly
- F 60 Display & Navigation Module Display
- F 61 Display & Navigation Module Display
- F 62 Display & Navigation Module Display
- F 63 Display & Navigation Module Display
- F 64 Display & Navigation Module Display
- F 65 Display & Navigation Module Display
- F 66 Display & Navigation Module Display
- F 67 Display & Navigation Module Display
- F 68 Multi-Media Module Navigation Assembly
- F 70 Display & Navigation Module Display
- F 71 IEEE Connector
- F 72 Multi-Media Module Navigation Assembly
- F 73 Junction Connector
- F 74 Stereo Component Amplifier Assembly
- F 75 Parking Assist ECU
- F 76 Parking Assist ECU
- F 77 Multi-Media Module Receiver Assembly
- F 78 Multi-Media Module Receiver Assembly
- F 79 Multi-Display Assembly
- F 80 Multi-Display Assembly
- F 81 Parking Assist ECU
- F 82 Multi-Media Module Receiver Assembly
- F 83 Multi-Display Assembly
- F 84 Multi-Media Module Receiver Assembly
- F 85 Stereo Component Amplifier Assembly
- F 86 Multi-Media Module Receiver Assembly
- F 90 Multi-Display Assembly

Position of Parts in Instrument Panel <LHD Front Separate Seat Type>

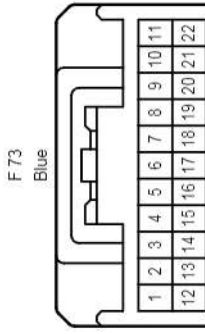
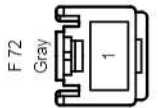
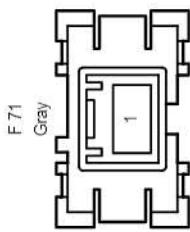
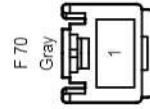
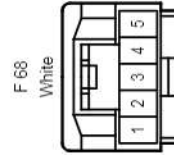
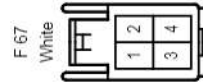
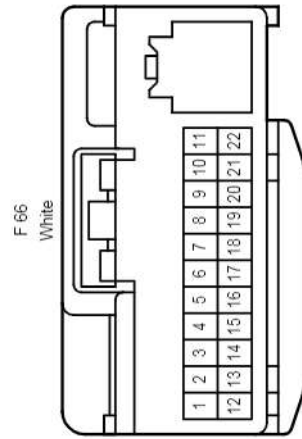
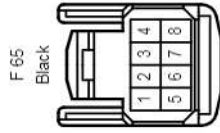
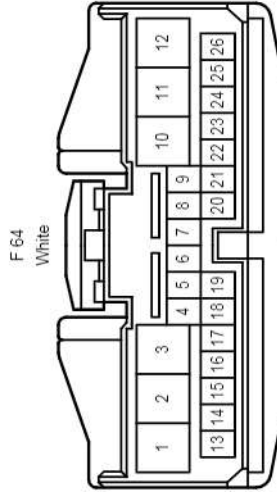
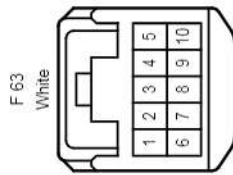
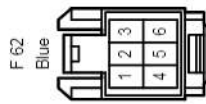
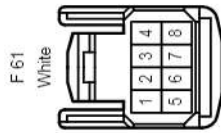
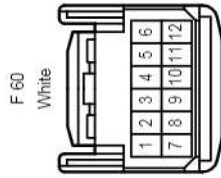
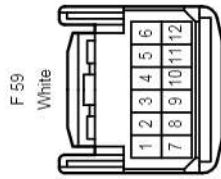
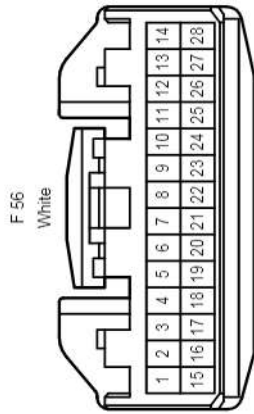
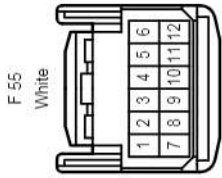
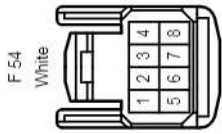
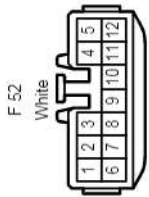
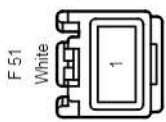

Position of Parts in Instrument Panel <LHD Front Separate Seat Type>

F 75
White

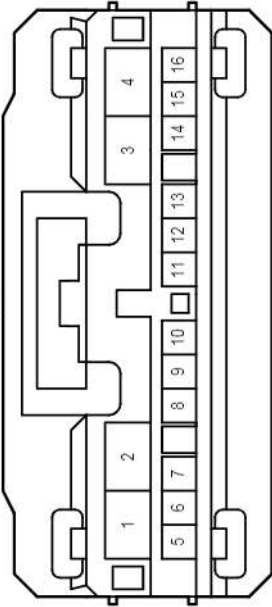

F 76
Black

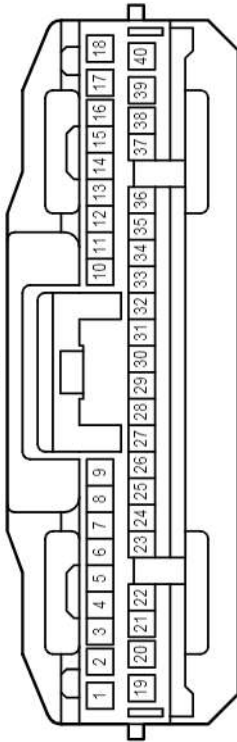

F 77
White

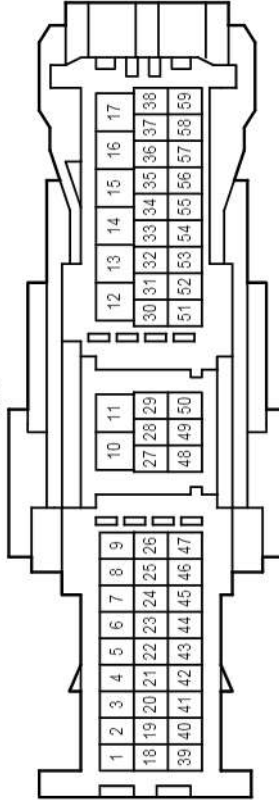

F 78
White

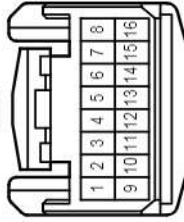

F 79
White

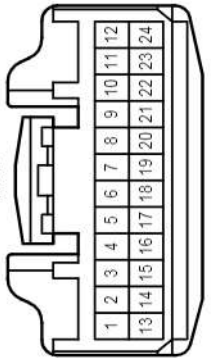

F 80
Gray

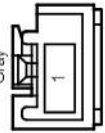

F 81
White

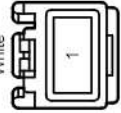

F 82
Blue

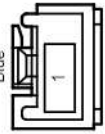

F 83
Blue

F 84
White

F 85
White

F 86
Gray

F 90
White

Position of Parts in Instrument Panel <LHD Front Separate Seat Type>

A 27	Four Wheel Drive Control ECU
A 28	Four Wheel Drive Control ECU
A 29	Front Blower with Fan Motor Sub-Assembly
A 30	Stop Light Switch Assembly
A 31	Accelerator Pedal Sensor Assembly
A 39	Stop Light Control Relay Assembly
A 49	Clutch Start Switch Assembly
A 50	Clutch Switch Assembly
G 1	Outer Mirror Switch Assembly
G 2	Outer Mirror Switch Assembly
G 3	Curtain Airbag Cutoff Switch
G 4	Headlight Cleaner Switch Assembly
G 5	Back Sonar or Clearance Sonar Switch Assembly
G 7	Outer Mirror Switch Assembly
G 8	Idle Up Switch
G 9	Headlight Leveling Switch
G 12	Center Differential Lock Switch
G 13	VSC Off Switch
G 14	Steering Heater Switch
G 15	Back Sonar or Clearance Sonar Switch Assembly
G 16	Outer Mirror Switch Assembly
G 17	Headlight Leveling Switch
K 27	Center Airbag Sensor Assembly
K 32	Center Airbag Sensor Assembly
K 37	Acceleration Sensor LH
L 27	Center Airbag Sensor Assembly
L 35	Acceleration Sensor RH
L 38	Center Airbag Sensor Assembly
L 43	Option Connector (Parking Assist-Sensor)
L 44	Option Connector (Parking Assist-Sensor)
P 1	Headphone Terminal
V 1	Seat Heater Switch
V 3	Front Indoor Electrical Key Oscillator
V 4	Suspension Control Switch
V 5	Suspension Control Switch
V 6	Seat Heater Switch
b 1	Front Passenger Side Squib Circuit
b 2	Front Passenger Side Squib Circuit

Z 63 Steering Wheel Heater Control Assembly

Position of Parts in Instrument Panel <LHD Front Separate Seat Type>

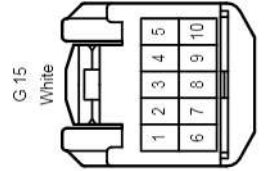
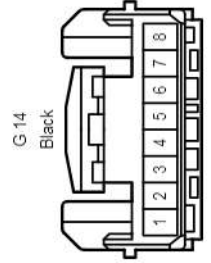
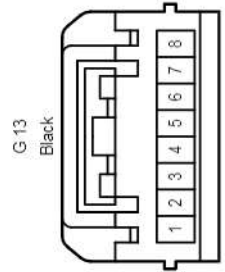
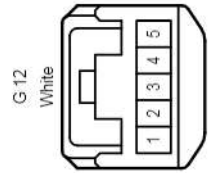
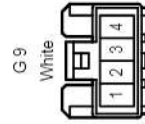
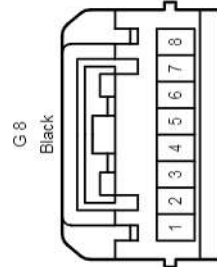
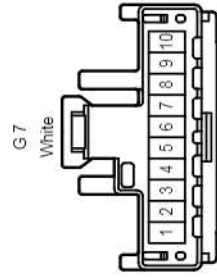
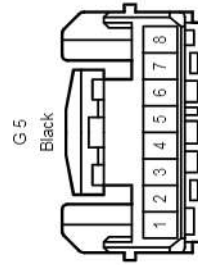
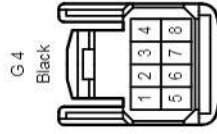
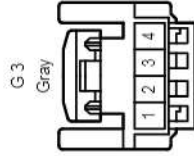
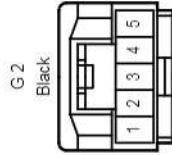
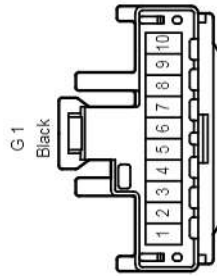
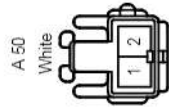
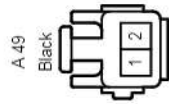
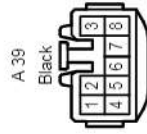
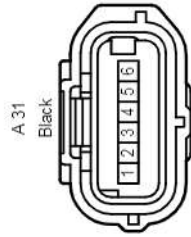
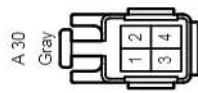
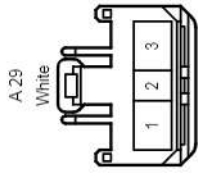
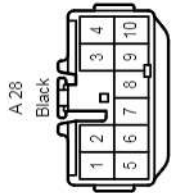
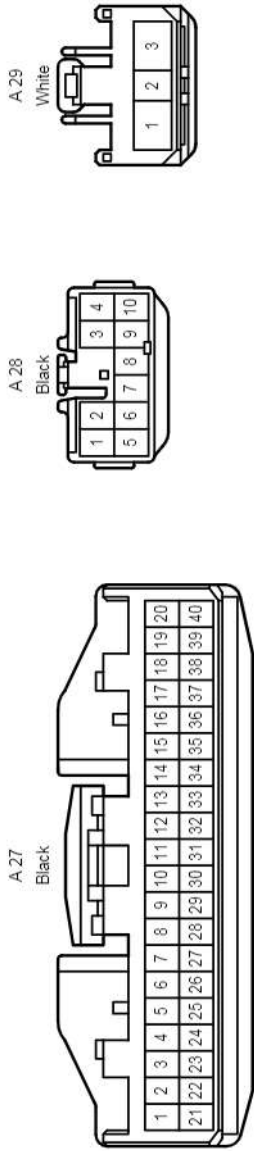

G 16
Black

G 17
Black

K 27
Yellow

K 32
Yellow

Position of Parts in Instrument Panel <LHD Front Separate Seat Type>

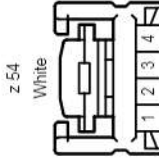
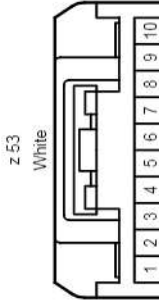
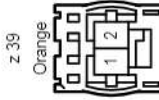
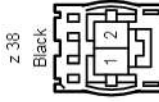
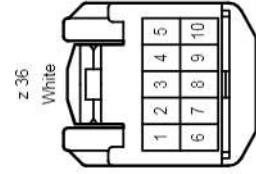
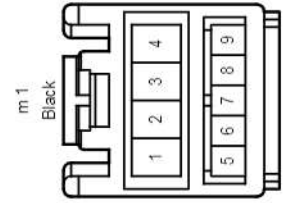
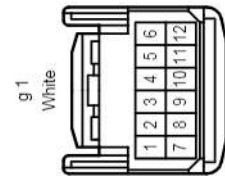
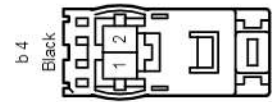
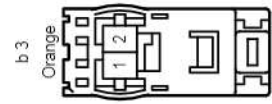
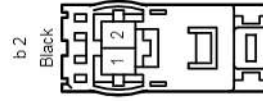
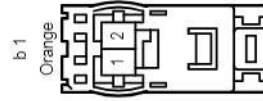
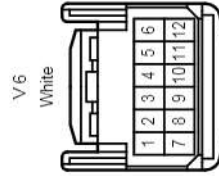
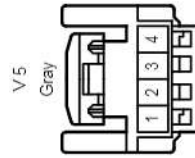
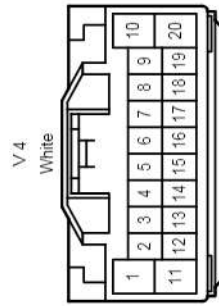
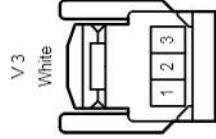
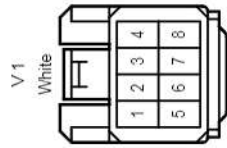
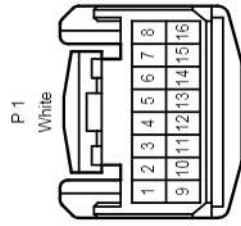
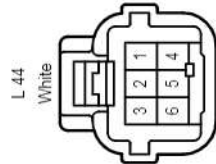
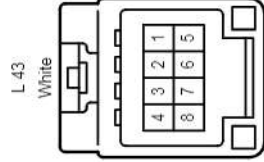
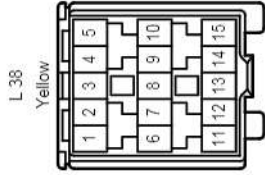
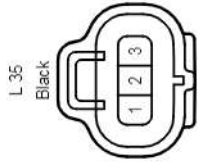
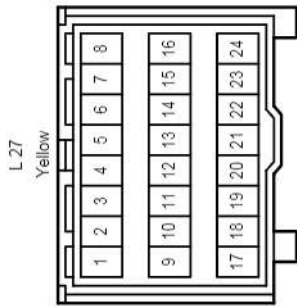
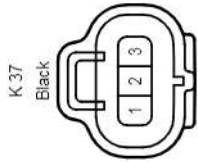

Wire and Wire in Instrument Panel <LHD Front Separate Seat Type>

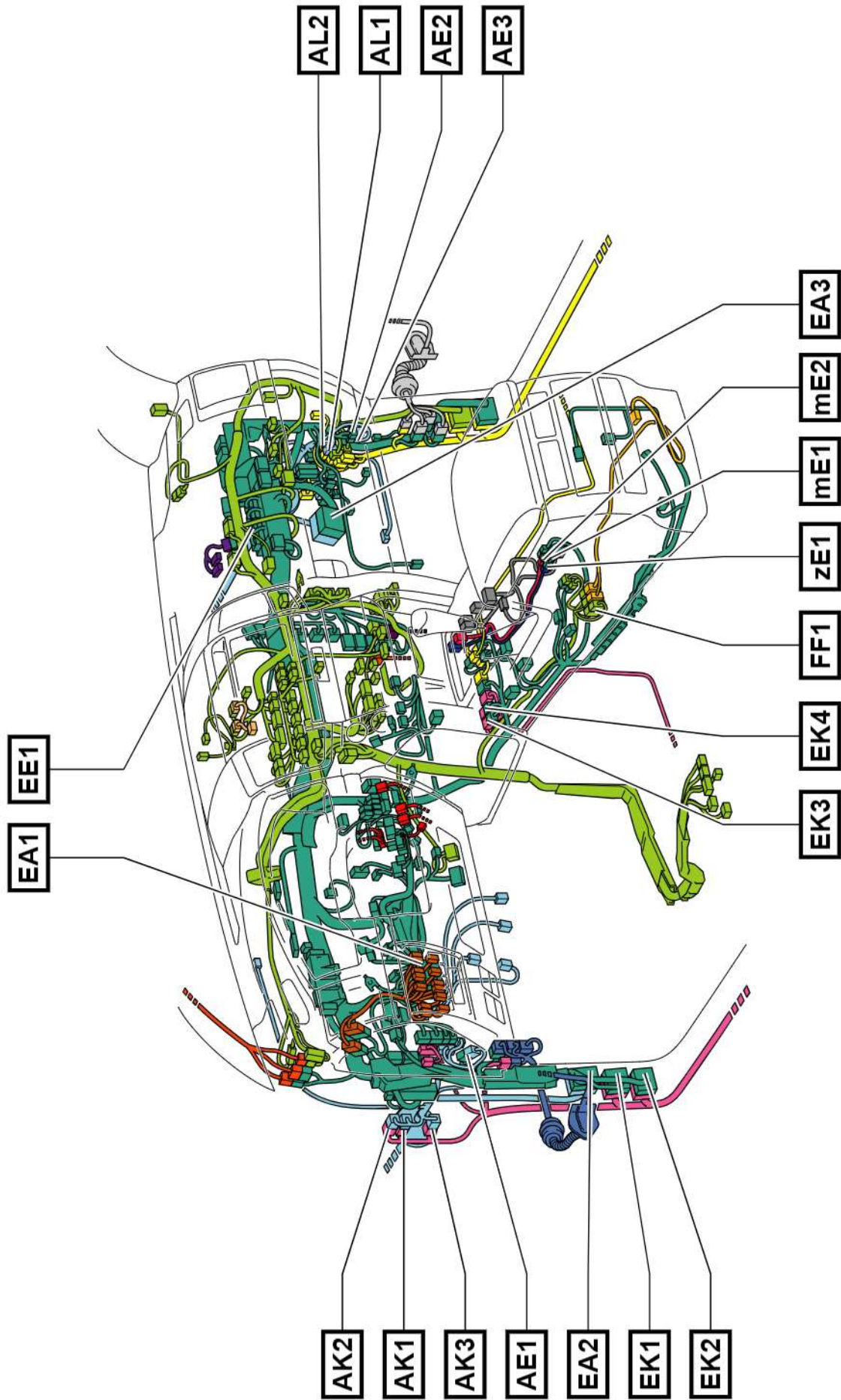

Wire and Wire in Instrument Panel <LHD Front Separate Seat Type>

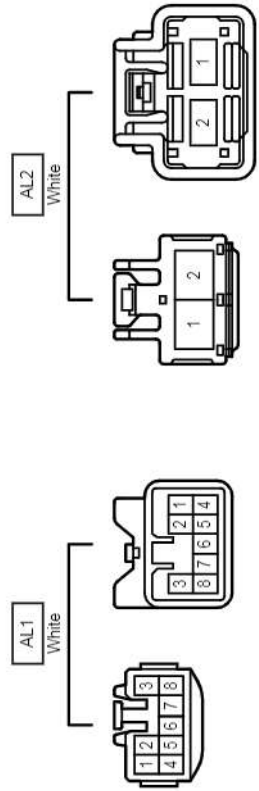
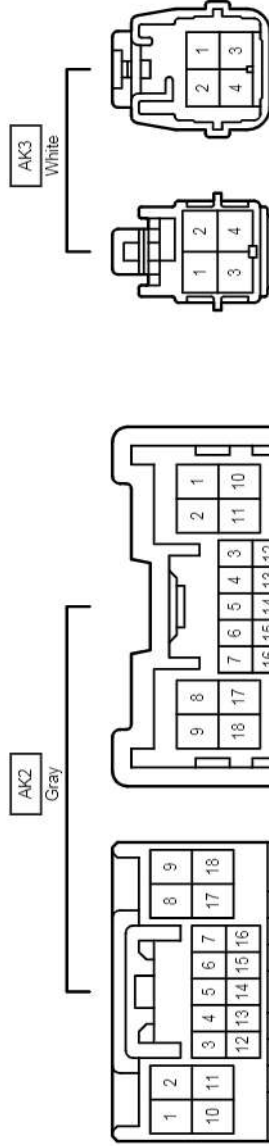
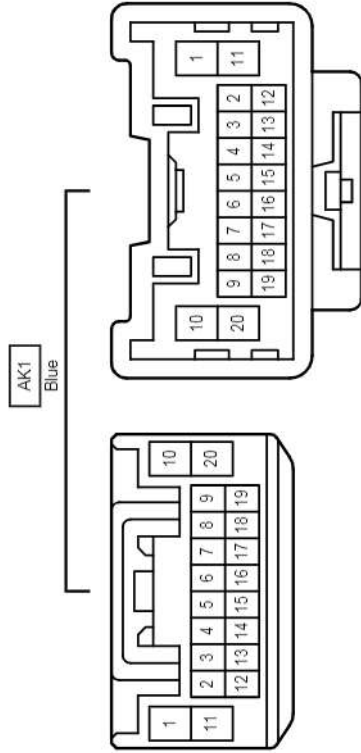
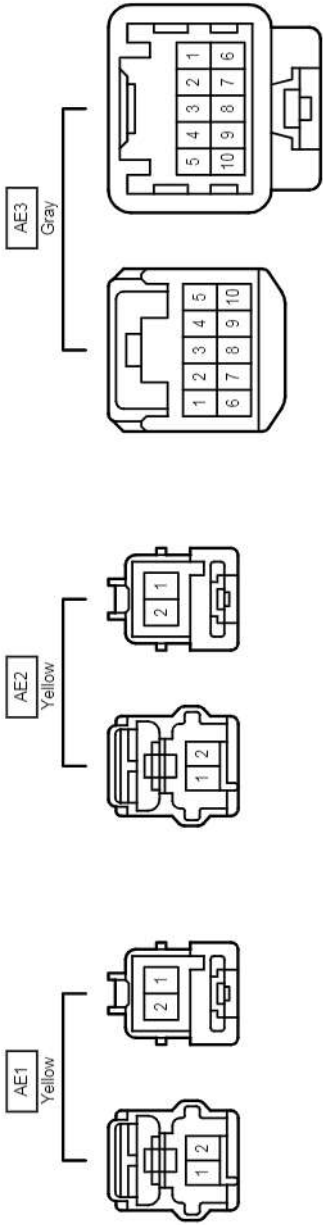

Wire and Wire in Instrument Panel <LHD Front Separate Seat Type>

EA1
White

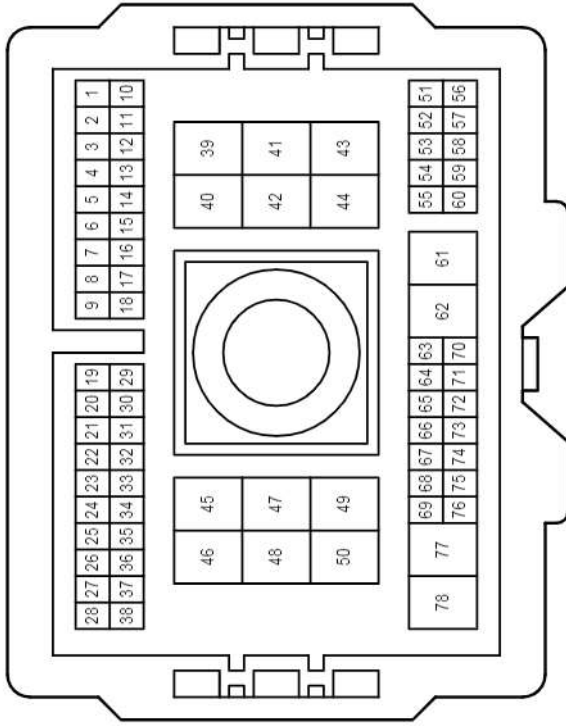
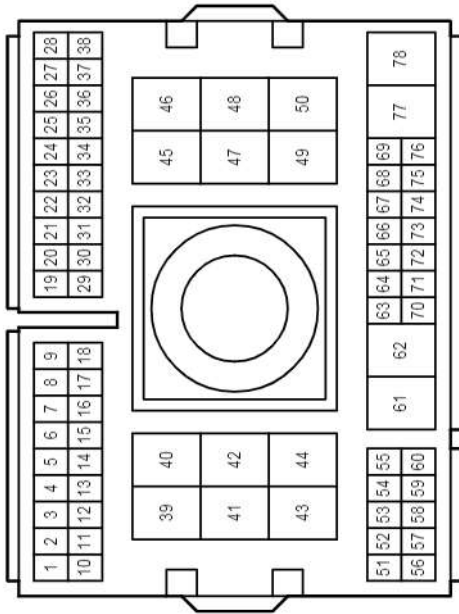

EA2
Gray

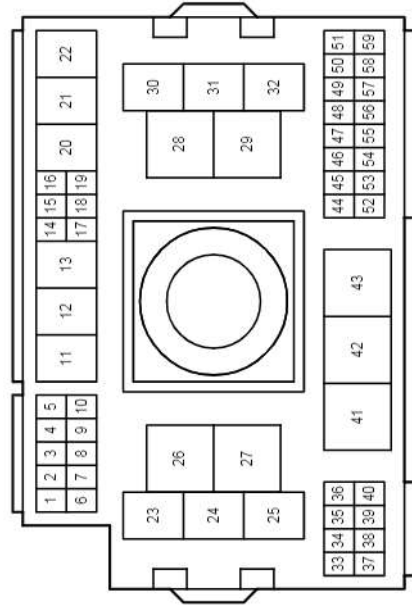

EA2
Gray

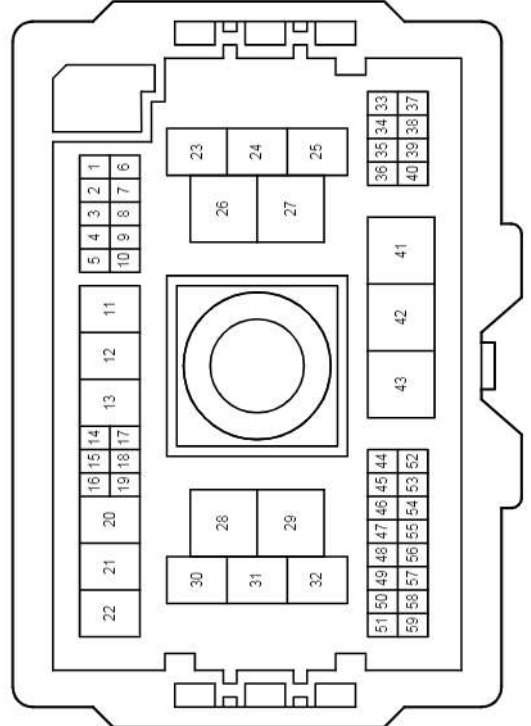

Wire and Wire in Instrument Panel <LHD Front Separate Seat Type>

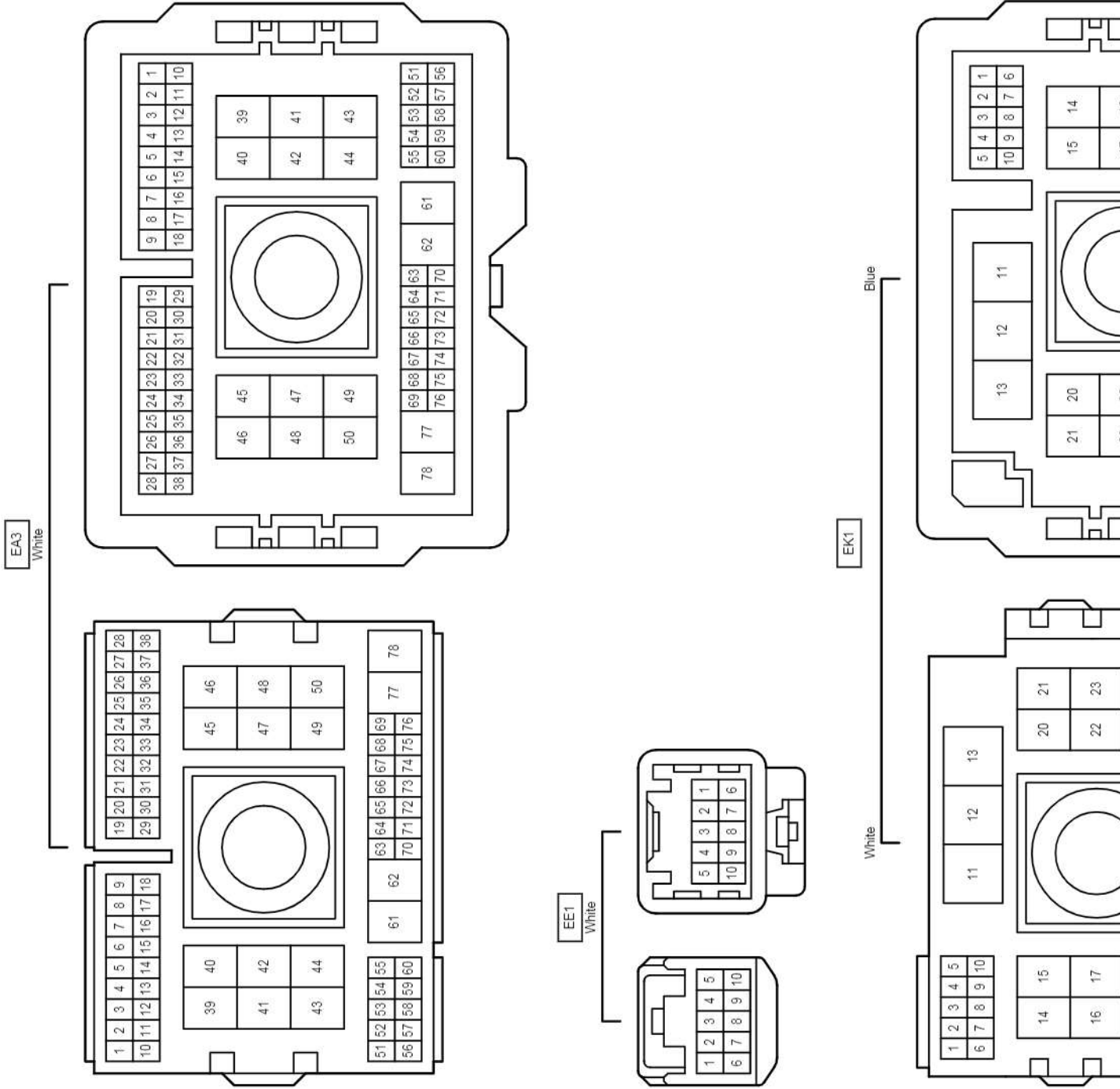

Wire and Wire in Instrument Panel <LHD Front Separate Seat Type>

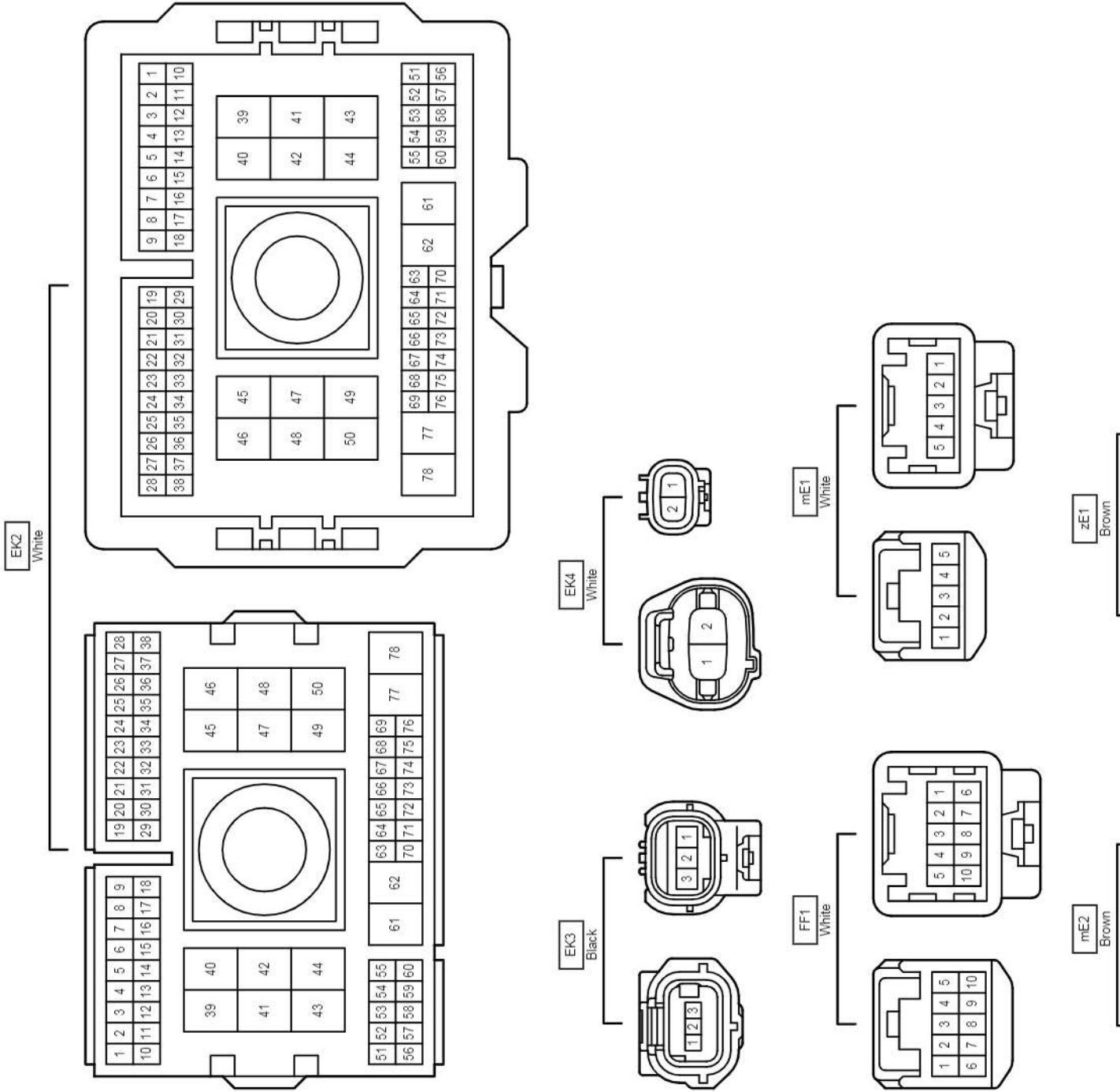

- * 1: Before Jul. 2009 Production
- * 2: From Jul. 2009 Production
- * 3: Liftgate Type Body
- * 4: Swing Type Body

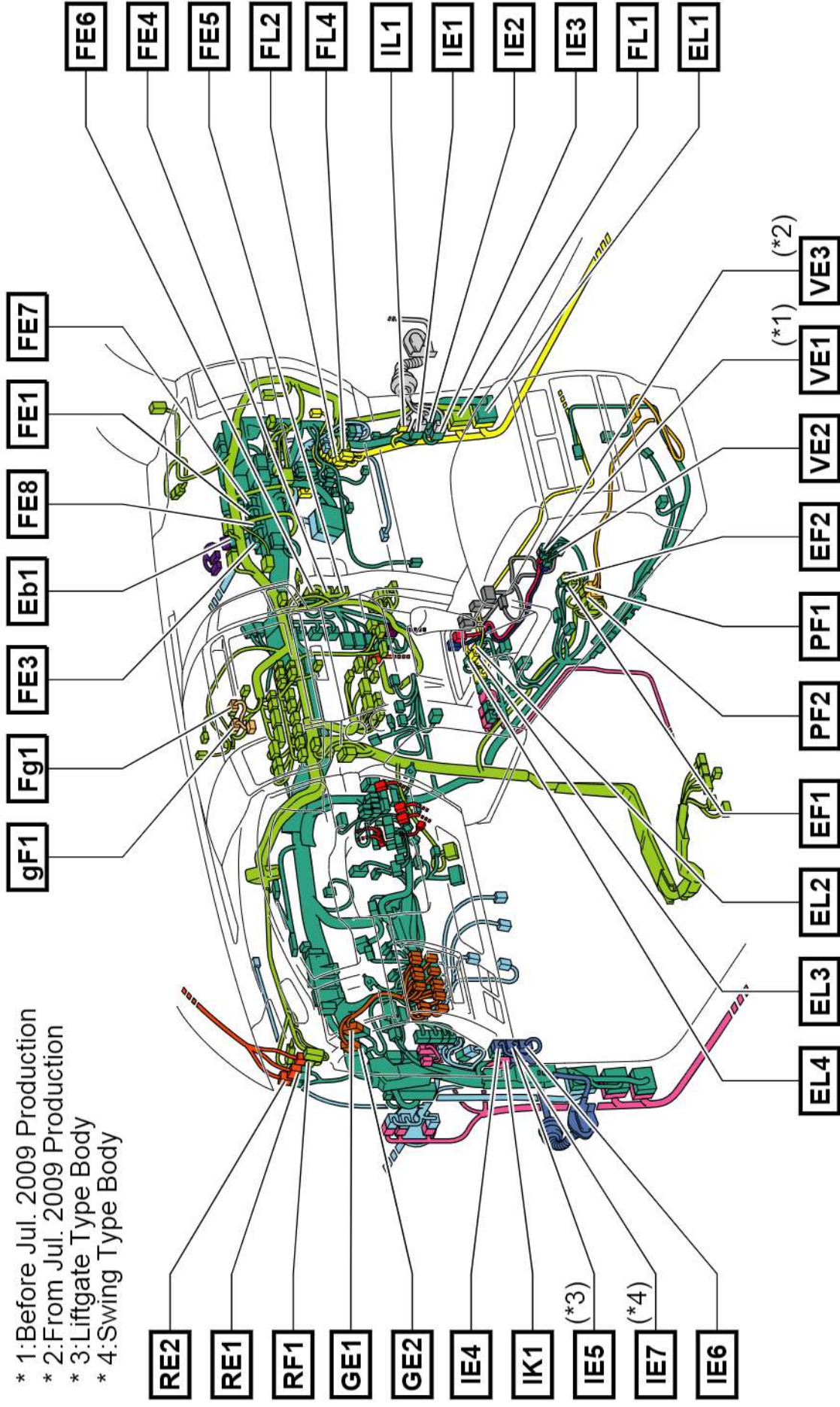

Wire and Wire in Instrument Panel <LHD Front Separate Seat Type>

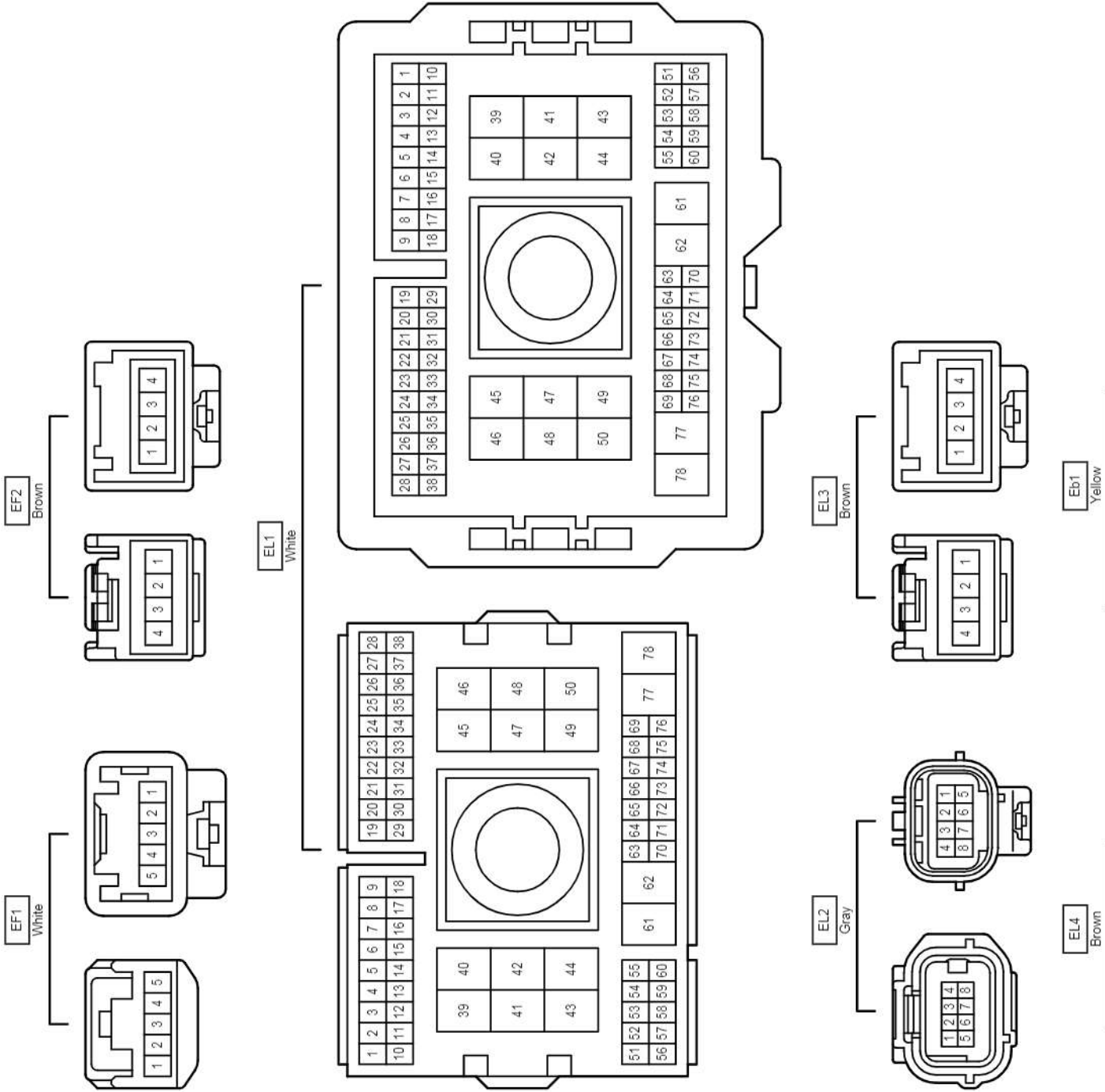

Wire and Wire in Instrument Panel <LHD Front Separate Seat Type>

FE1
White

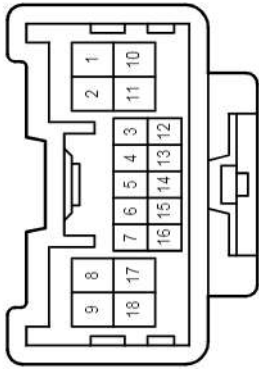
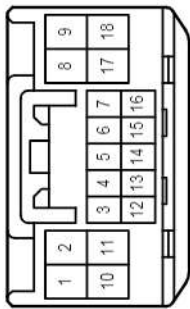

FE3
White

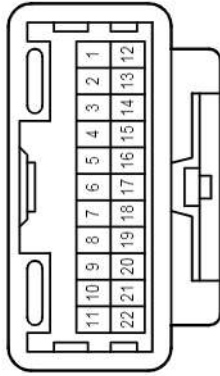
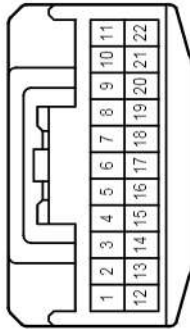

FE4
White

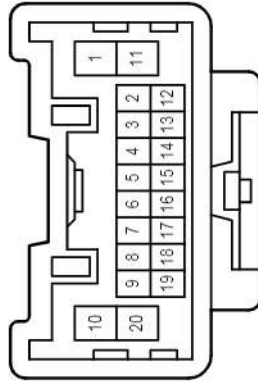
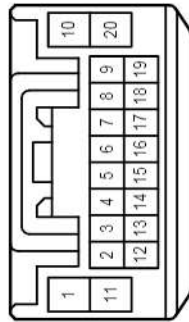

FE5
White

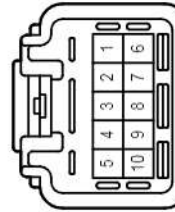
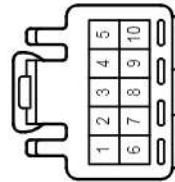

FE6
White

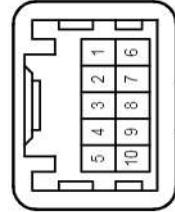
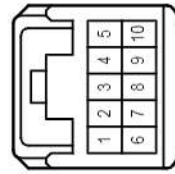

Wire and Wire in Instrument Panel <LHD Front Separate Seat Type>

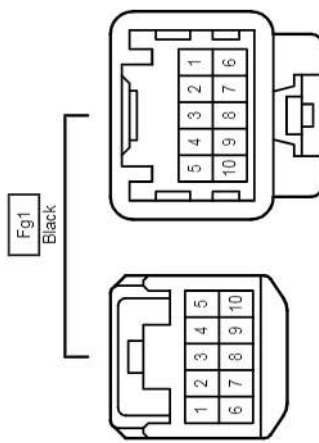
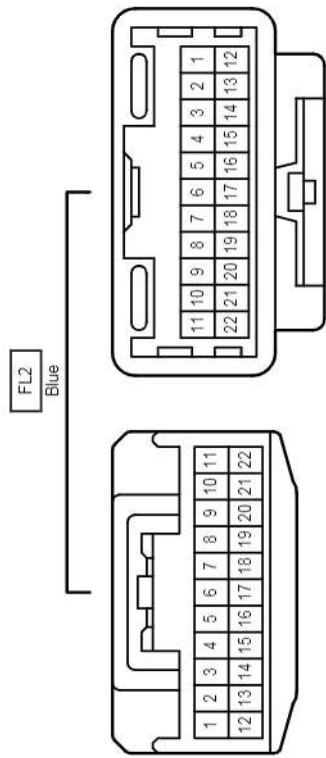
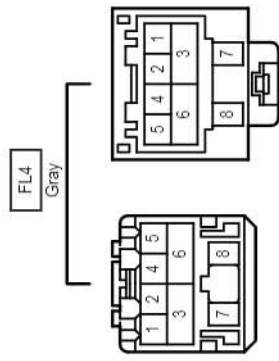
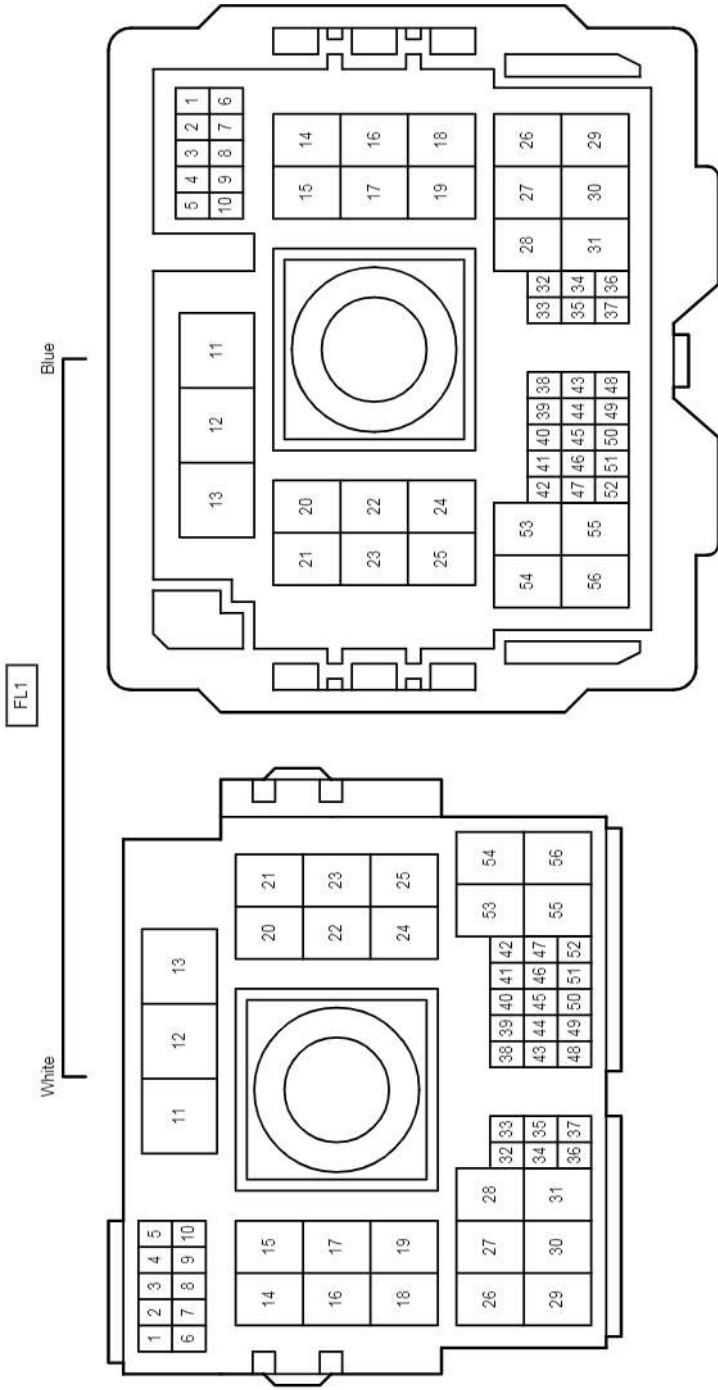

cardiagn.com

Wire and Wire in Instrument Panel <LHD Front Separate Seat Type>

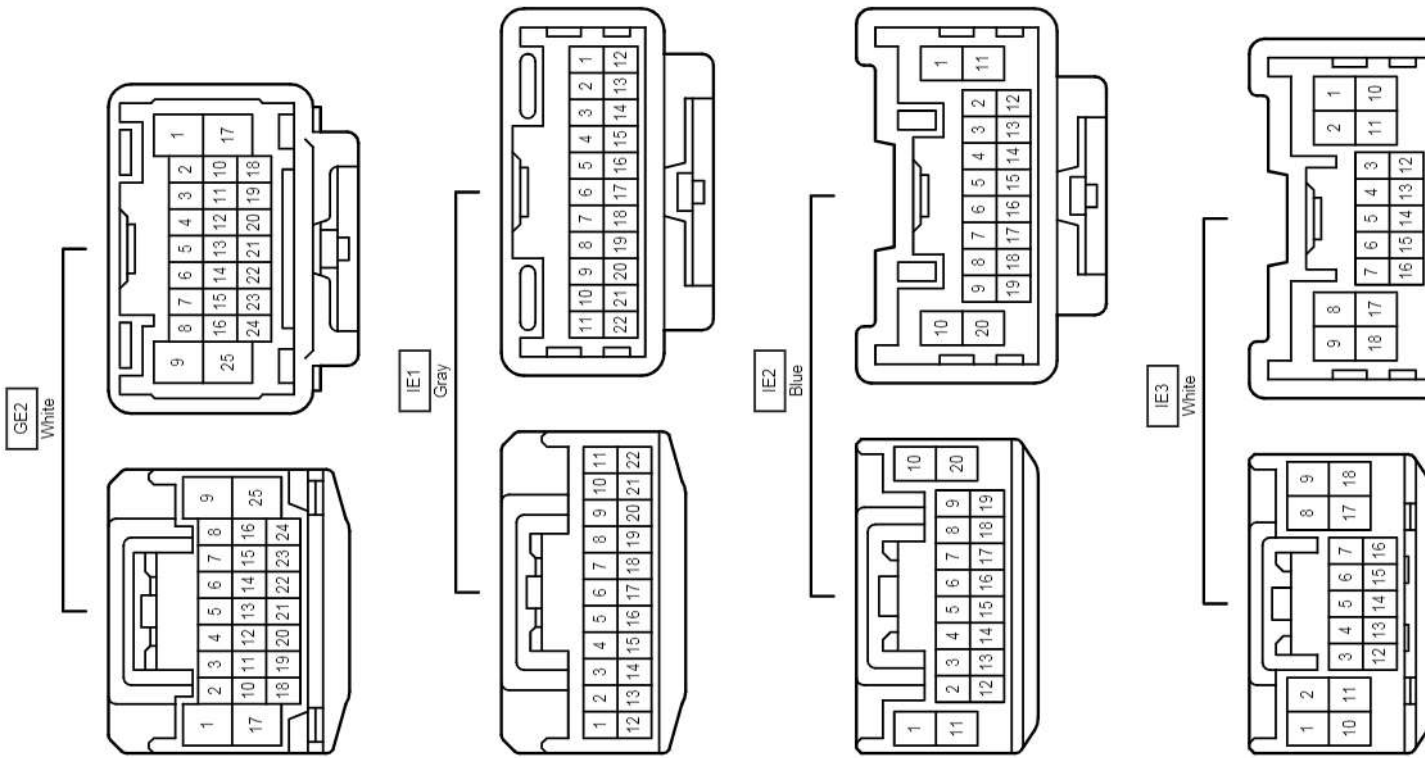

Wire and Wire in Instrument Panel <LHD Front Separate Seat Type>

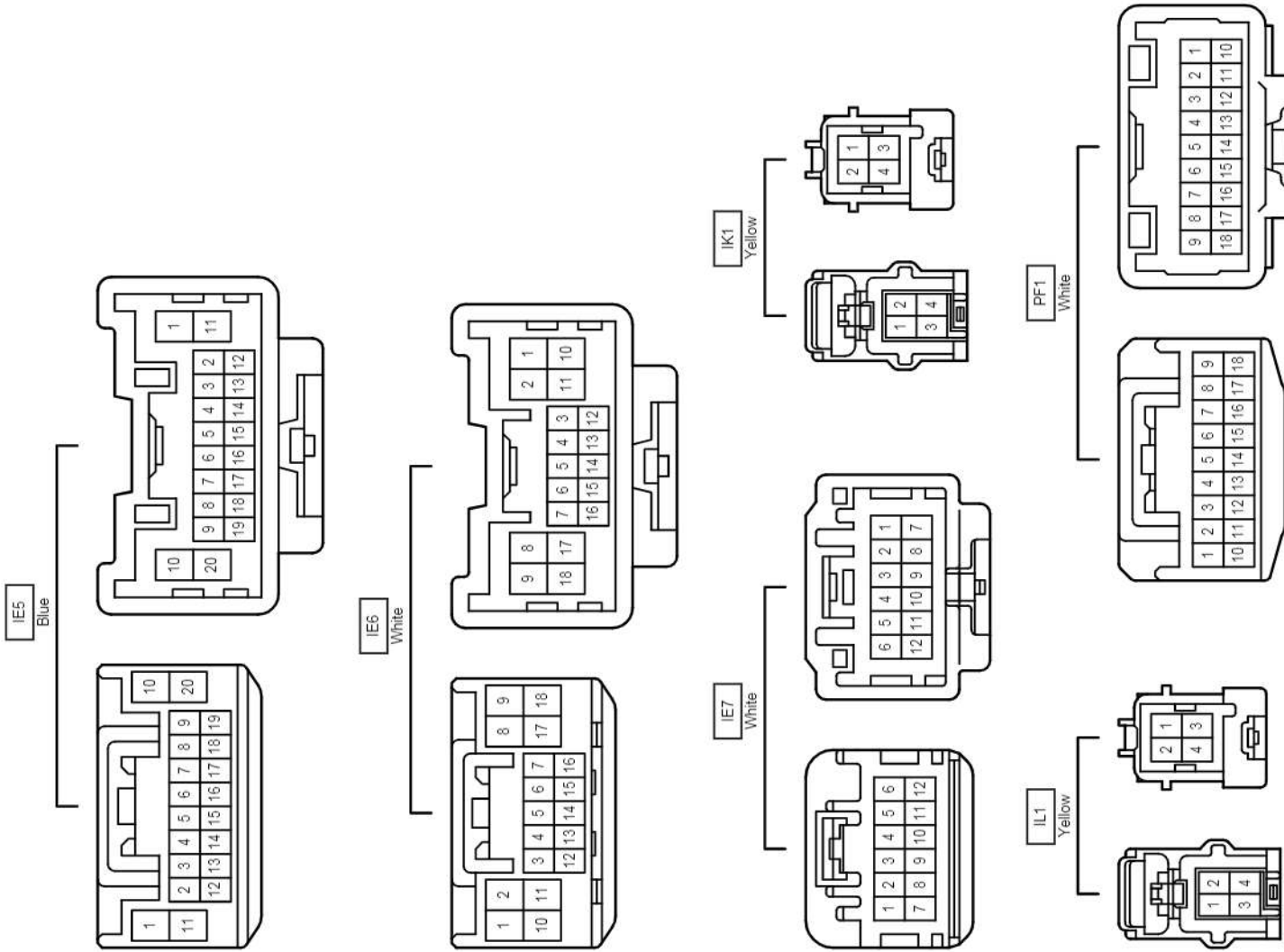

Wire and Wire in Instrument Panel <LHD Front Separate Seat Type>

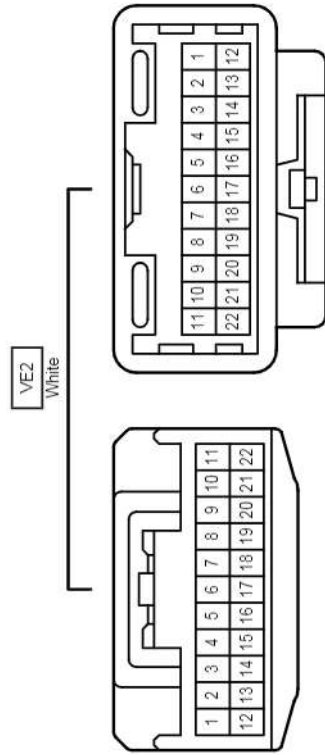
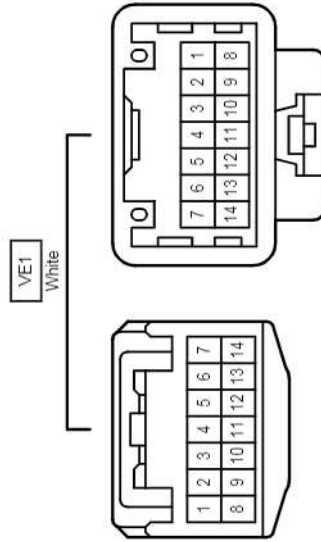
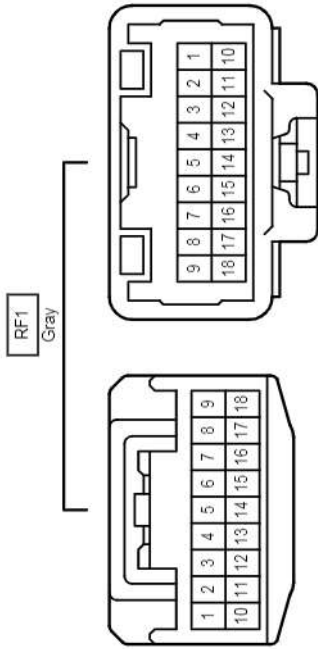
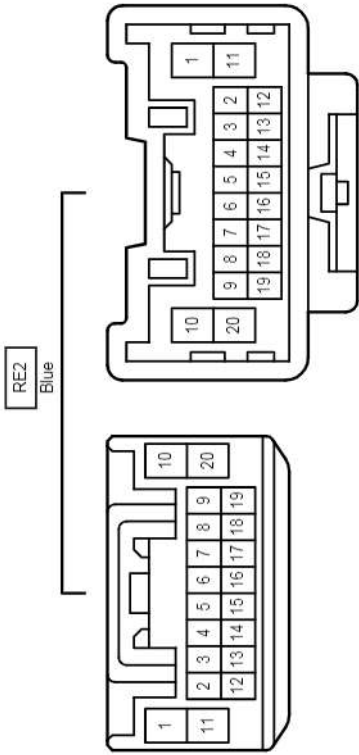

Ground Points in Instrument Panel <RHD Front Separate Seat Type>

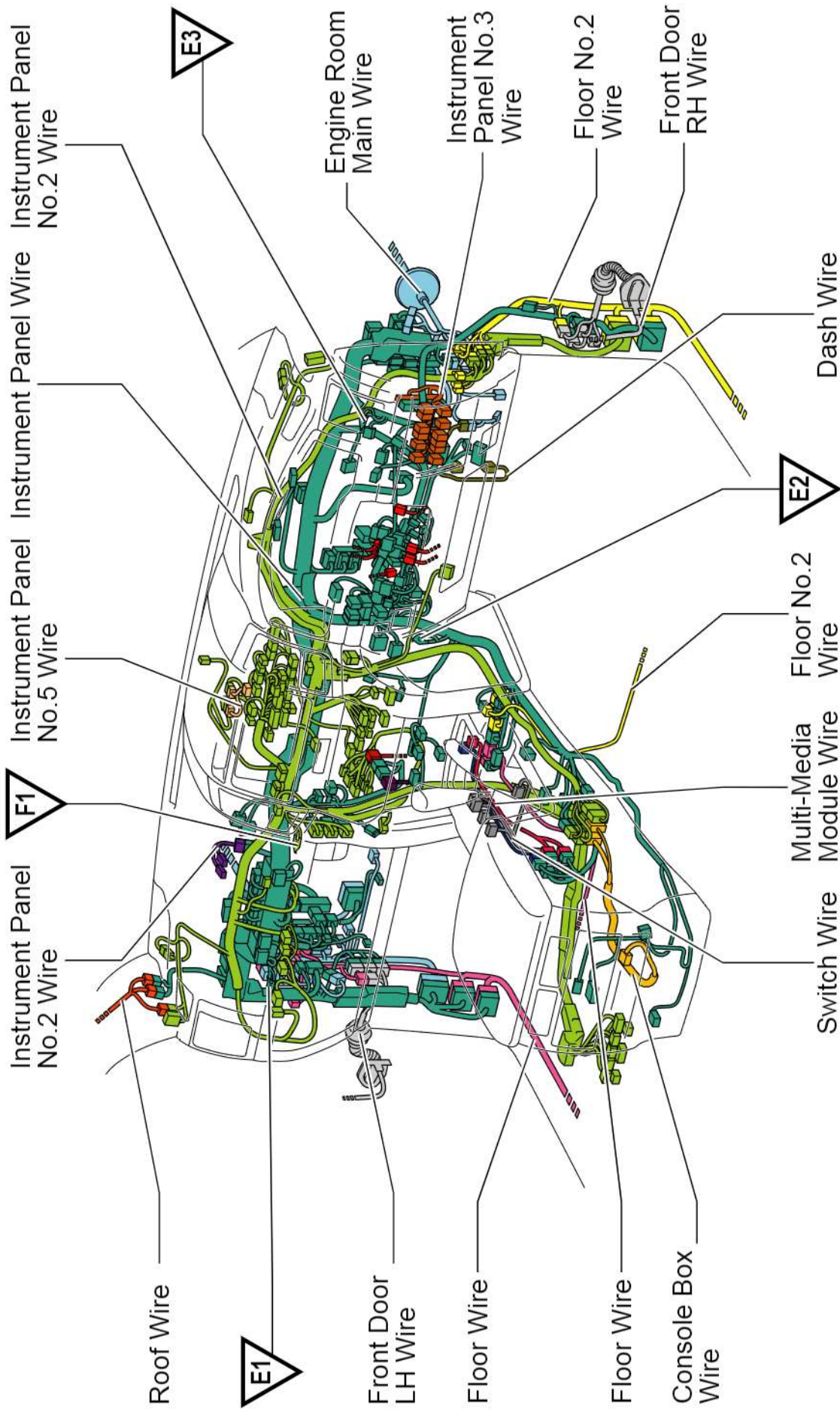

Position of Parts in Instrument Panel <RHD Front Separate Seat Type>

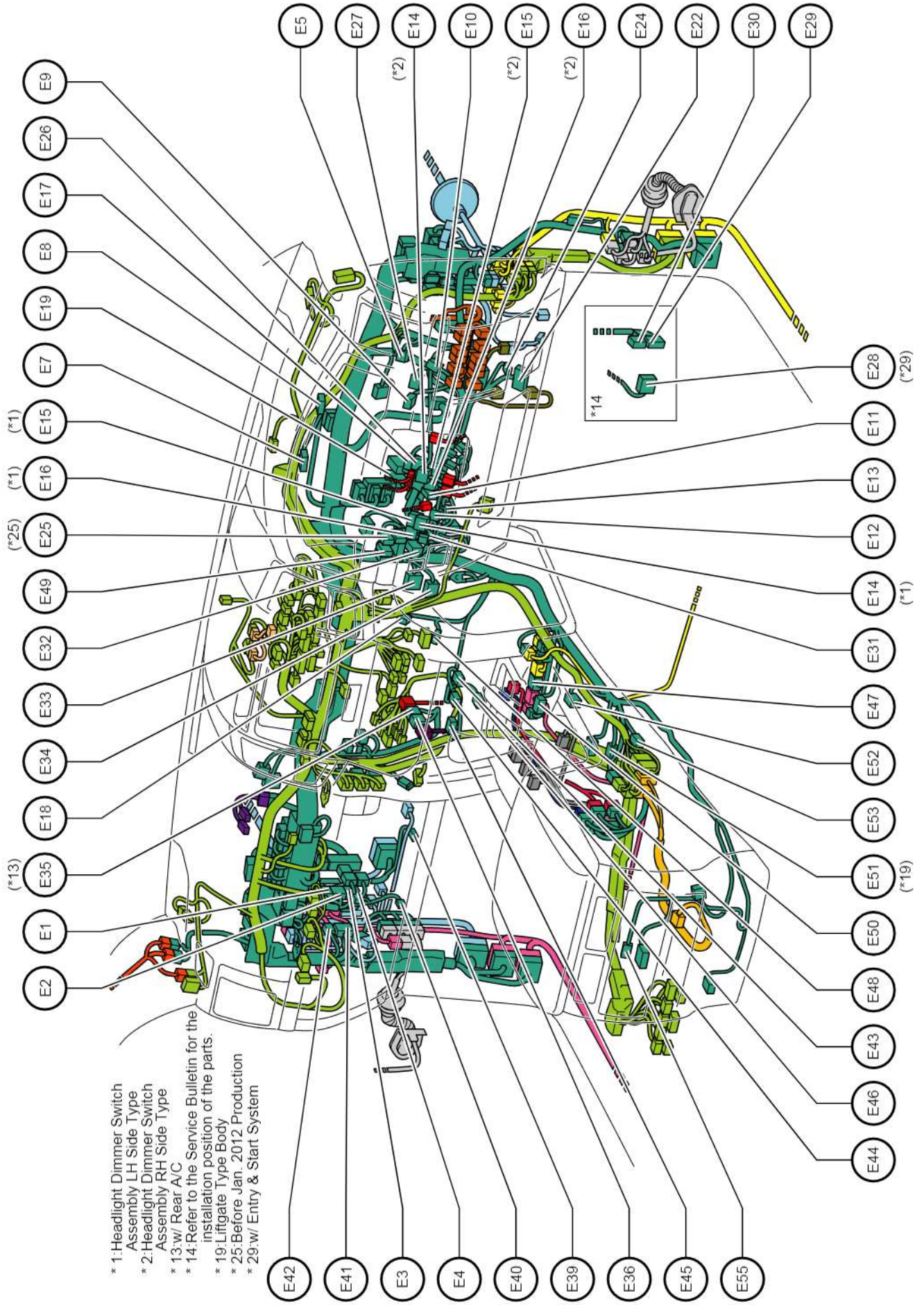

Position of Parts in Instrument Panel <RHD Front Separate Seat Type>

E 1	Main Body ECU
E 2	Main Body ECU
E 3	Main Body ECU
E 4	Main Body ECU
E 5	Skid Control Buzzer Assembly
E 7	Combination Meter Assembly
E 8	Combination Meter Assembly
E 9	Light Control Rheostat
E 10	No.1 Clearance Warning Buzzer
E 11	Steering Sensor
E 12	Spiral Cable Sub-Assembly
E 13	Spiral Cable Sub-Assembly
E 14	Headlight Dimmer Switch Assembly
E 15	Windshield Wiper Switch Assembly
E 16	Windshield Wiper Switch Assembly
E 17	Power Tilt Motor
E 18	Engine Switch
E 19	Turn Signal Flasher Assembly
E 22	DLC3
E 24	Lower No.1 Instrument Panel Airbag Assembly
E 25	VSC Off Switch
E 26	Steering Lock Actuator Assembly
E 27	Multiplex Tilt and Telescopic ECU
E 28	ID Code Box
E 29	Certification ECU Assembly
E 30	Certification ECU Assembly
E 31	Network Gateway ECU
E 32	Room Temperature Sensor
E 33	Quick Heater Assembly
E 34	Quick Heater Assembly
E 35	A/C Amplifier Assembly
E 36	A/C Amplifier Assembly
E 39	Glove Box Light Assembly
E 40	Lower No.2 Instrument Panel Airbag Assembly
E 41	Seat Belt Control ECU
E 42	Seat Belt Control ECU
E 43	Cigarette Lighter Assembly
E 44	Cigarette Lighter Illumination Assembly
E 45	Ash Receptacle Light Sub-Assembly
E 46	Front Power Outlet Socket Assembly
E 47	Center Airbag Sensor Assembly
E 48	Transfer Position Switch
E 49	Center Differential Lock Switch
E 50	Yaw Rate Sensor Assembly

Position of Parts in Instrument Panel <RHD Front Separate Seat Type>

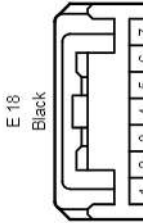
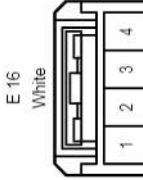
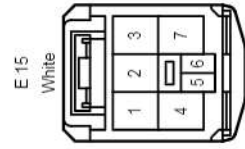
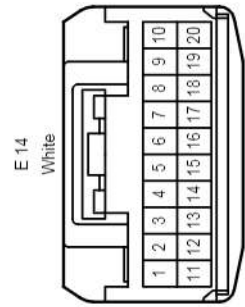
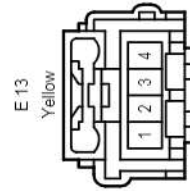
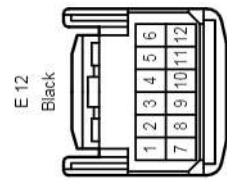
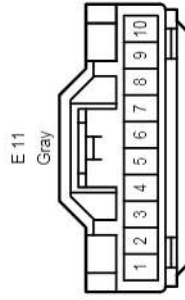
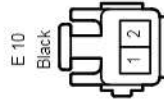
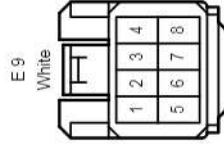
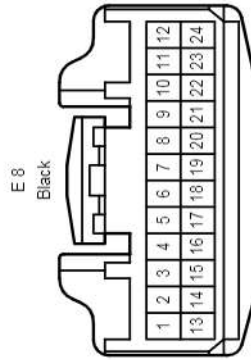
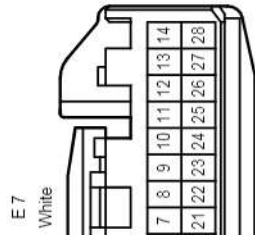
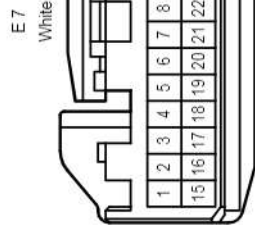
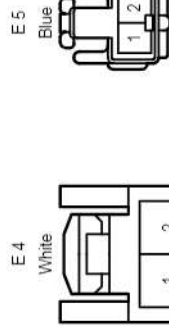
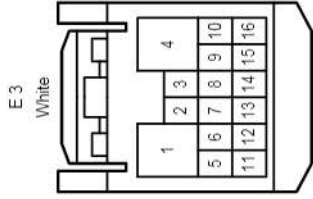
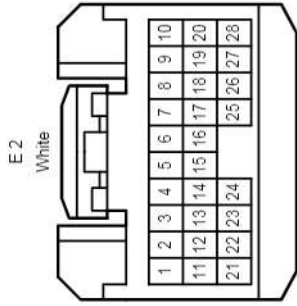
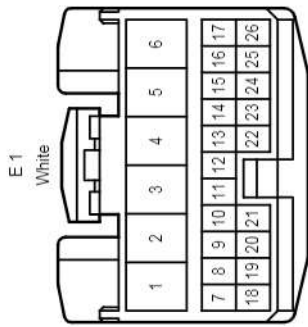

Position of Parts in Instrument Panel <RHD Front Separate Seat Type>

E 22
White

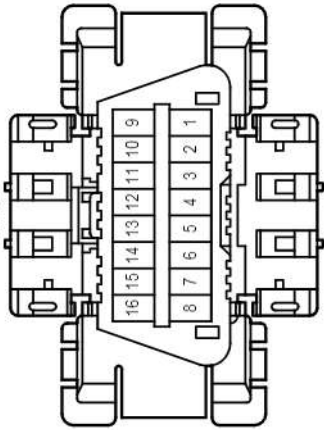

E 24
Black

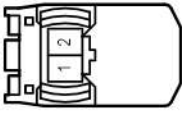

E 25
Black

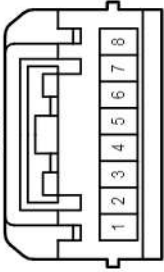

E 26
Black

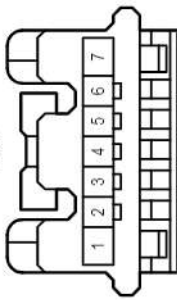

E 27
White

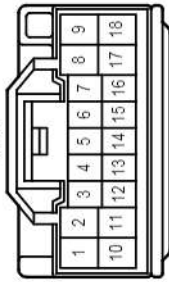

E 28
White

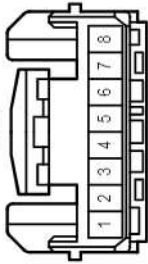

E 29
White

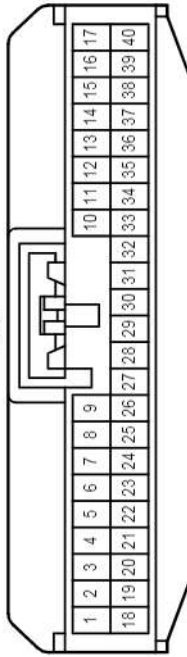

E 30
White

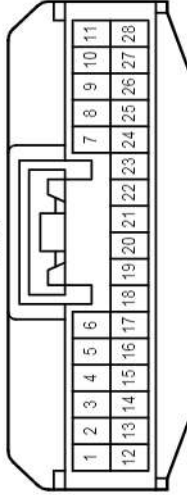

E 31
White

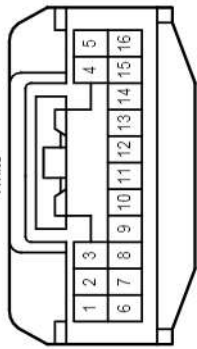

E 32
Black



E 33
White

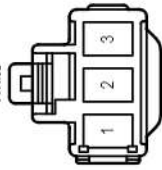

E 34
White

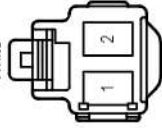

E 35
White

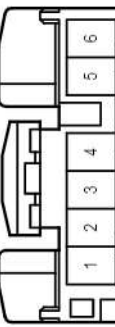

E 36
White

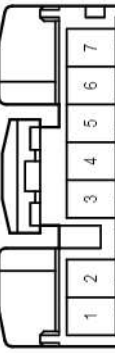

E 39
Black

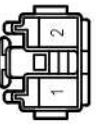

E 40
Black

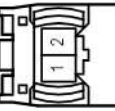

Position of Parts in Instrument Panel <RHD Front Separate Seat Type>

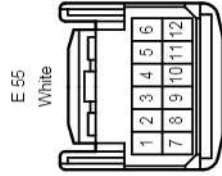
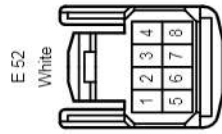
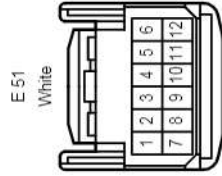
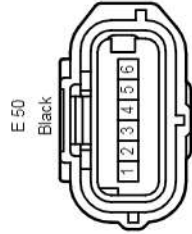
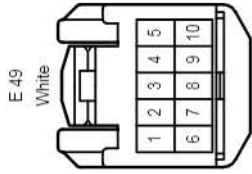
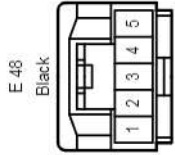
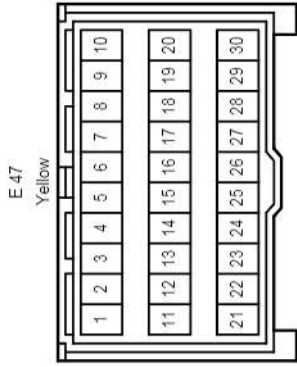
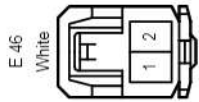

Position of Parts in Instrument Panel <RHD Front Separate Seat Type>

E 58	Junction Connector
E 59	Junction Connector
E 60	Junction Connector
E 61	Junction Connector
E 62	Junction Connector
E 63	Junction Connector
E 64	Junction Connector
E 65	Junction Connector
E 66	Junction Connector
E 67	Junction Connector
E 68	Junction Connector
E 69	Junction Connector
E 70	Junction Connector
E 71	Junction Connector
E 72	Junction Connector
E 73	Junction Connector
E 74	Junction Connector
E 75	Junction Connector
E 76	Junction Connector
E 77	Steering Control ECU
E 78	Steering Control ECU
E 79	Steering Control ECU
E 80	Steering Actuator Assembly
E 81	A/C Amplifier Assembly
E 83	Windshield Wiper ECU , Short Connector
E 84	Short Connector
E 85	Windshield Wiper ECU
E 86	Double Lock Door Control Relay Assembly
E 87	Differential Lock Switch
E 88	Deceleration Sensor
E 89	Heater Blower Switch
E 90	Cooling Box Assembly
E 91	Option Connector (Parking Assist-Sensor)
E 92	Option Connector (Bus Buffer)
E 93	Ignition or Starter Switch Assembly
E 94	Un-Lock Warning Switch Assembly
E 95	Transponder Key Amplifier
E 96	Transponder Key ECU Assembly
E 97	Idle Up Switch
E 98	Key Inter Lock Solenoid
E 99	Shift Lock Control ECU Sub-Assembly
E 100	Main Switch Assembly
E 101	Headlight Leveling ECU Assembly
E 102	Power Steering ECU Assembly

Position of Parts in Instrument Panel <RHD Front Separate Seat Type>

E 58

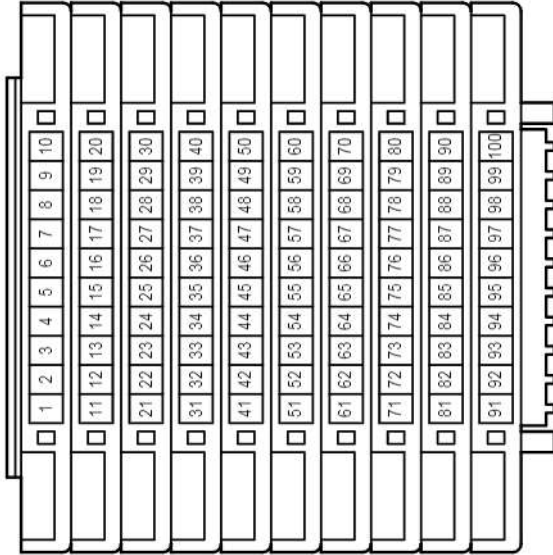

E 59

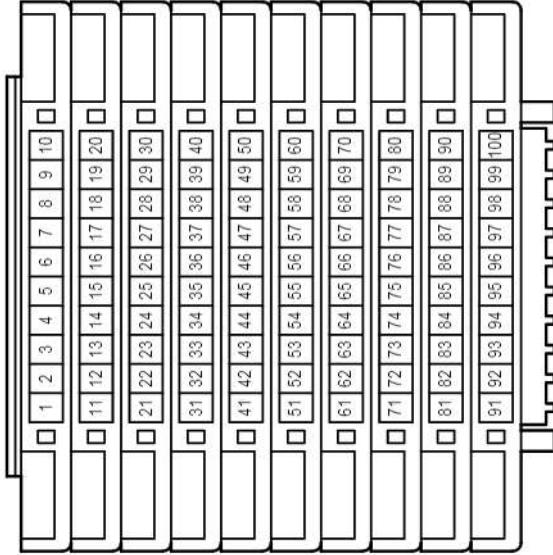

E 60

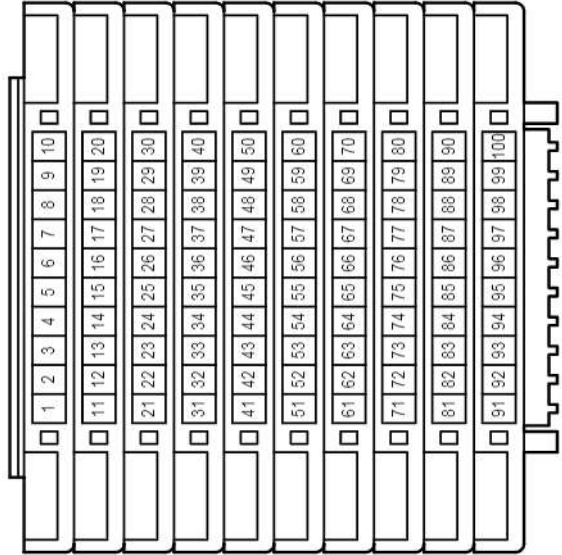

E 61

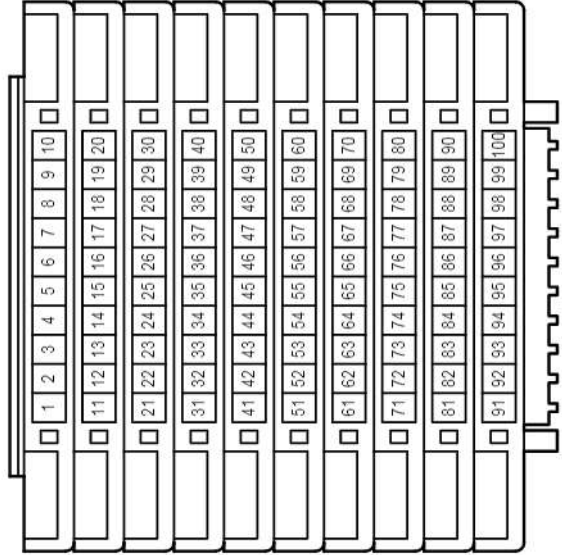

E 62
White



E 63
Gray



E 64
Black



E 65
Black

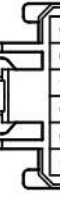

Position of Parts in Instrument Panel <RHD Front Separate Seat Type>

E 69
Gray

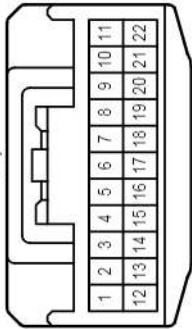

E 70
Gray

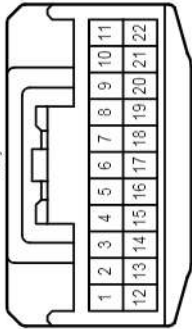

E 71
Gray

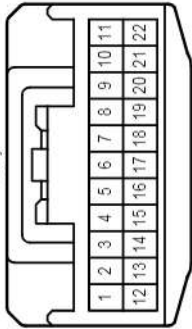

E 72
Gray

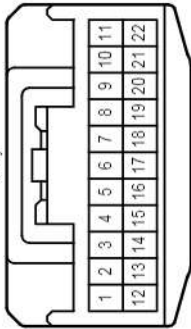

E 73
Gray

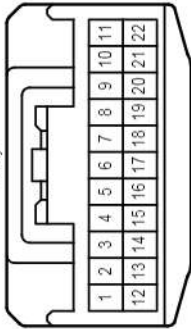

E 74
Gray

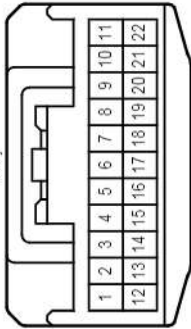

E 75
Gray

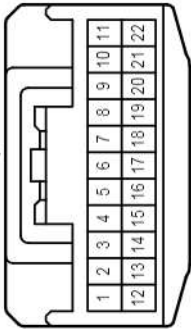

E 76
Gray

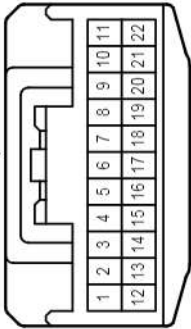

E 77
White

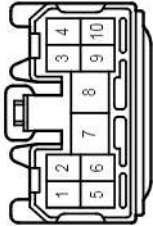

E 78
White

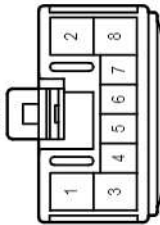

E 79
White

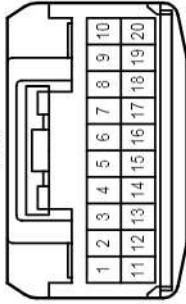

E 80
White

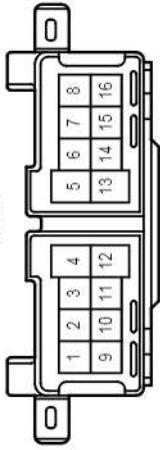

E 81
White

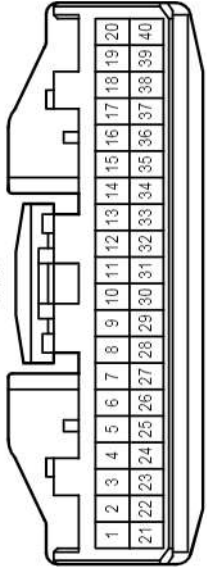

E 83
Blue

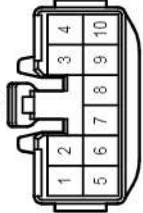

E 84
Blue

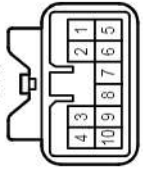

Position of Parts in Instrument Panel <RHD Front Separate Seat Type>

E 89
Black

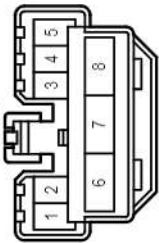

E 90
White



E 91
White

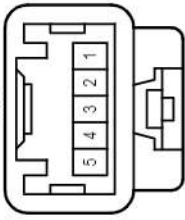

E 92
White

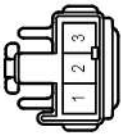

E 93
White

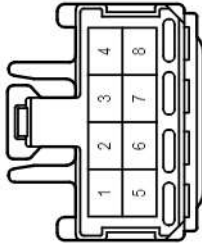

E 94
White



E 95
Black

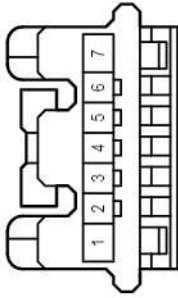

E 96
Black

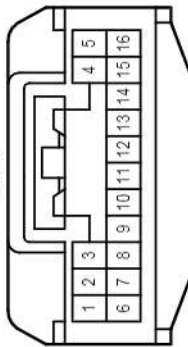

E 97
Black

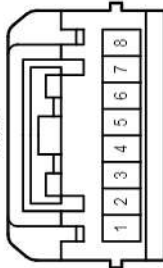

E 98
Black



E 99
White

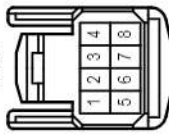

E 100
White



E 101
White

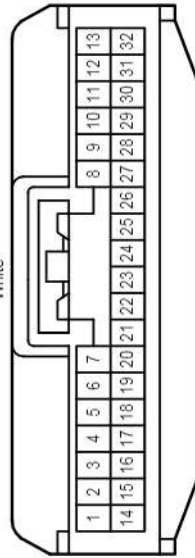

E 102
White

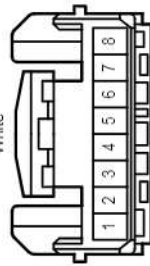

E 103
White

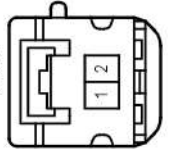

E 104
Black

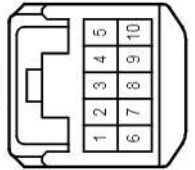

E 105
Black

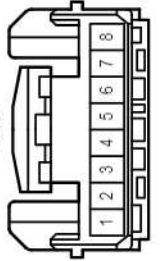

E 106
White

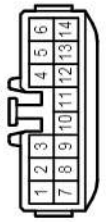

Position of Parts in Instrument Panel <RHD Front Separate Seat Type>

E111
Black

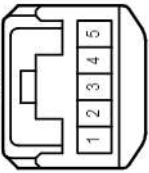

E112
Black

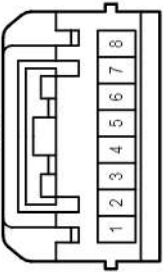

Position of Parts in Instrument Panel <RHD Front Separate Seat Type>

- A 27 Four Wheel Drive Control ECU
- A 28 Four Wheel Drive Control ECU
- A 29 Front Blower with Fan Motor Sub-Assembly
- A 30 Stop Light Switch Assembly
- A 31 Accelerator Pedal Sensor Assembly
- A 39 Stop Light Control Relay Assembly
- F 1 Radio Receiver Assembly
- F 2 Stereo Component Amplifier Assembly
- F 3 Stereo Component Amplifier Assembly
- F 5 Amplifier Antenna Assembly
- F 6 Front No.4 Speaker Assembly
- F 7 Front No.2 Speaker Assembly RH , Short Connector
- F 8 Front No.2 Speaker Assembly LH , Short Connector
- F 9 Automatic Light Control Sensor
- F 10 A/C Control Assembly
- F 11 Hazard Warning Signal Switch Assembly
- F 12 Clearance Warning ECU Assembly
- F 12 Clearance Warning ECU Assembly
- F 13 Front No.3 Speaker Assembly RH
- F 14 Front No.3 Speaker Assembly LH
- F 16 Temperature Control Switch Assembly LH
- F 17 Temperature Control Switch Assembly RH
- F 18 Stereo Component Amplifier Assembly
- F 19 Radio Receiver Assembly
- F 20 Junction Connector
- F 21 Junction Connector
- F 22 Junction Connector
- F 23 Radio Receiver Assembly
- F 25 Radio Receiver Assembly
- F 27 Multi-Display
- F 28 Multi-Display
- F 29 Multi-Display
- F 30 Multi-Display
- F 31 Multi-Display
- F 32 Navigation ECU
- F 34 Navigation ECU
- F 35 Radio Receiver Assembly
- F 36 Radio Receiver Assembly

Position of Parts in Instrument Panel <RHD Front Separate Seat Type>

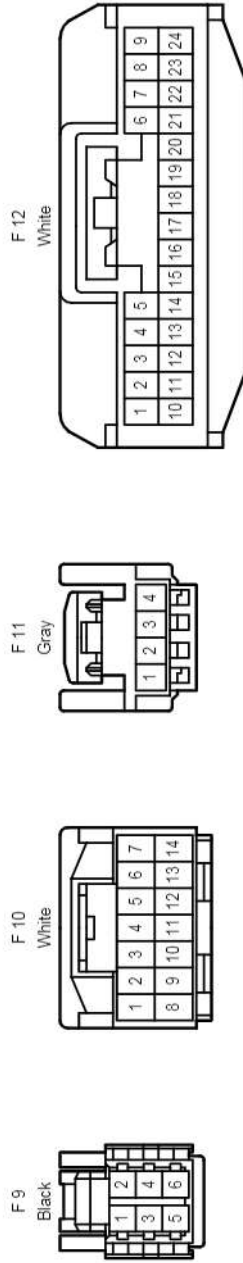
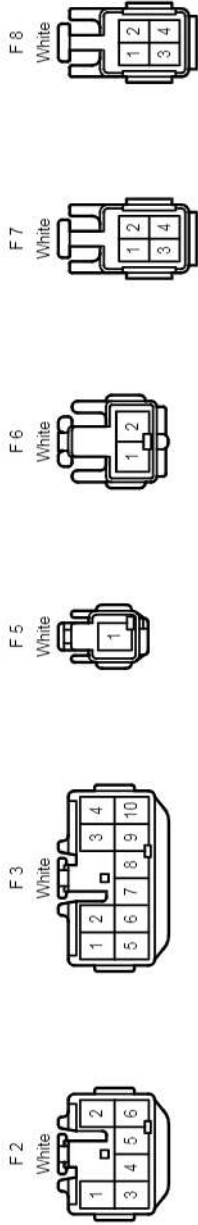
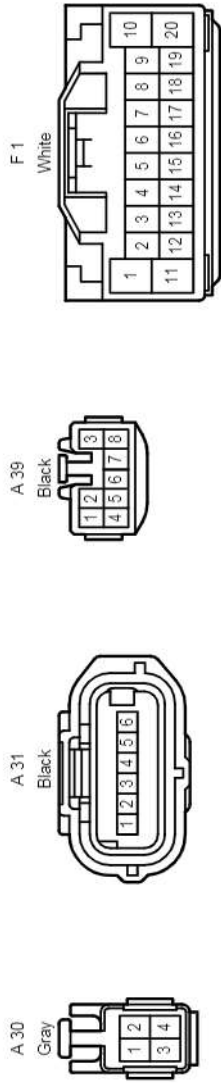
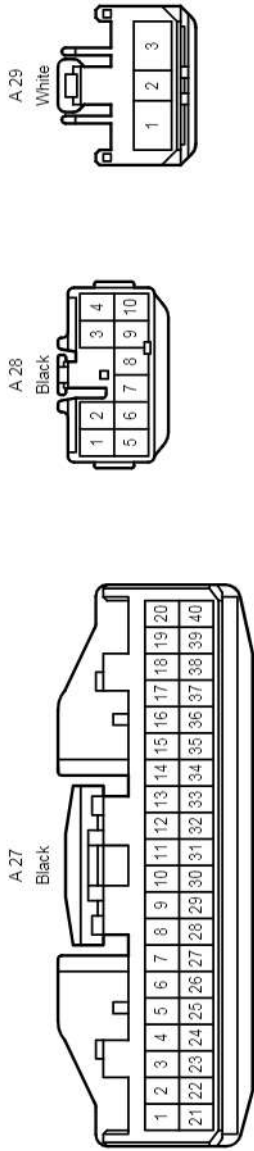

(Before Aug. 2007 Production)

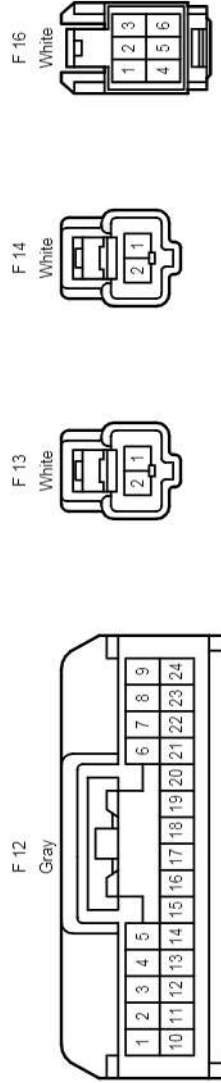

(From Aug. 2007 Production)

cardiagn.com

Position of Parts in Instrument Panel <RHD Front Separate Seat Type>

F 20
Gray

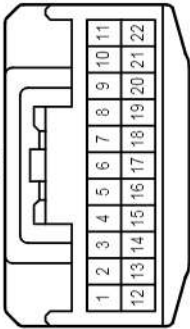

F 21
Black

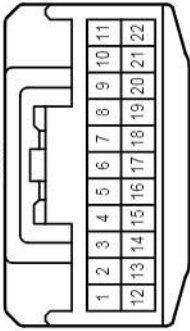

F 22
White

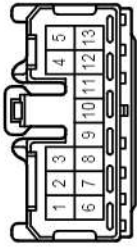

F 23
White

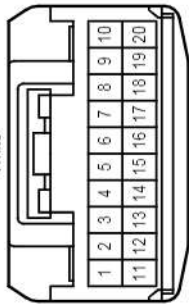

F 25
White

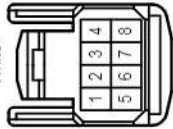

F 27
White

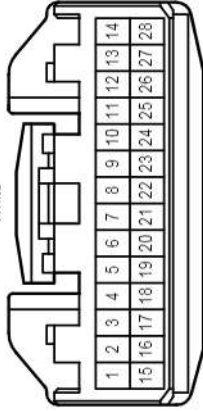

F 28
White

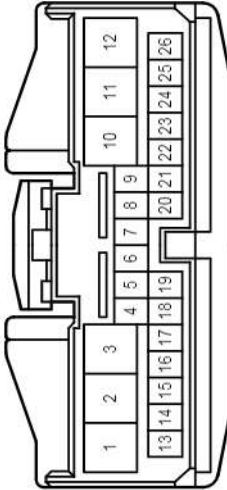

F 29
Blue

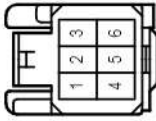

F 30
White

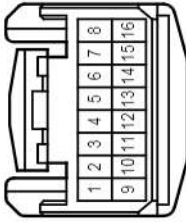

F 31
White

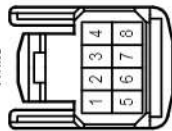

F 32
White

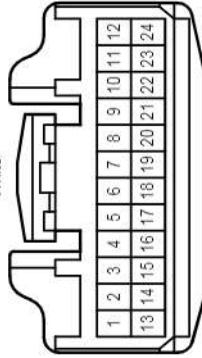

F 34
White

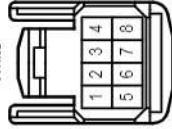

F 35
White

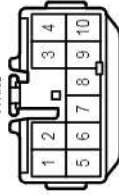

F 36
White

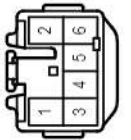

Position of Parts in Instrument Panel <RHD Front Separate Seat Type>

F 37	Stereo Component Amplifier Assembly
F 38	Airbag Cut Off Switch Cylinder Sub-Assembly
F 41	Short Connector
F 42	Short Connector
F 43	Parking Assist ECU
F 44	Parking Assist ECU
F 45	Option Connector (Back Guide Monitor)
F 46	Navigation ECU
F 47	Navigation Antenna Assembly
F 48	Multi-Display
F 49	Parking Assist ECU
F 50	Parking Assist ECU
F 51	Navigation ECU
F 52	Stereo Component Amplifier Assembly
F 54	Radio Receiver Assembly
F 55	Radio Receiver Assembly
F 56	Radio Receiver Assembly
F 59	Stereo Component Amplifier Assembly
F 60	Display & Navigation Module Display
F 61	Display & Navigation Module Display
F 62	Display & Navigation Module Display
F 63	Display & Navigation Module Display
F 64	Display & Navigation Module Display
F 65	Display & Navigation Module Display
F 66	Display & Navigation Module Display
F 67	Display & Navigation Module Display
F 68	Multi-Media Module Navigation Assembly
F 69	Display & Navigation Module Display
F 70	Display & Navigation Module Display
F 71	IEEE Connector
F 72	Multi-Media Module Navigation Assembly
F 73	Junction Connector
F 74	Stereo Component Amplifier Assembly
F 75	Parking Assist ECU
F 76	Parking Assist ECU
F 77	Multi-Media Module Receiver Assembly
F 78	Multi-Media Module Receiver Assembly
F 79	Multi-Display Assembly
F 82	Multi-Media Module Receiver Assembly
F 83	Multi-Display Assembly
F 84	Multi-Media Module Receiver Assembly
F 85	Stereo Component Amplifier Assembly
F 86	Multi-Media Module Receiver Assembly
F 88	Parking Assist ECU

Position of Parts in Instrument Panel <RHD Front Separate Seat Type>

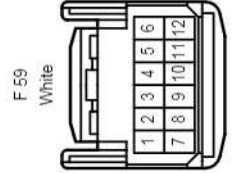
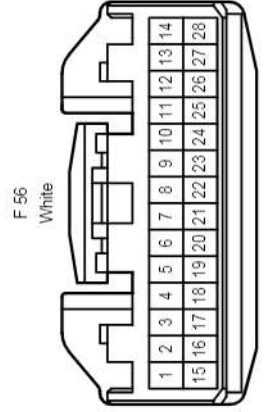
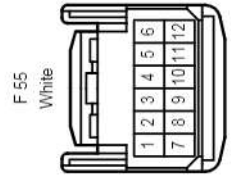
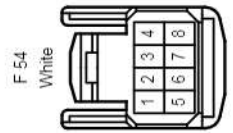
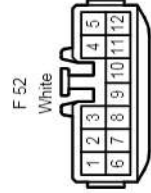
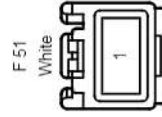
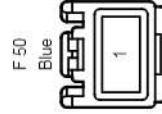
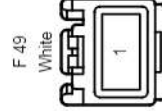
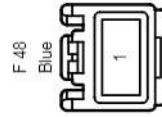
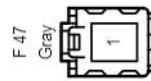
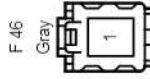
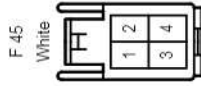
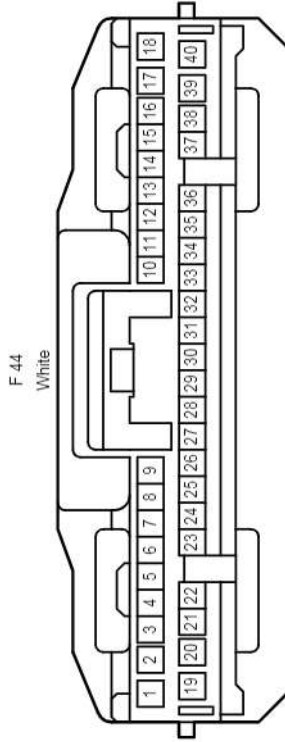
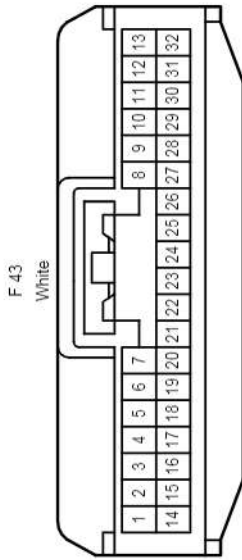
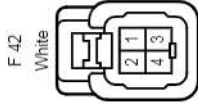
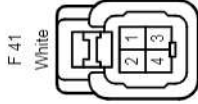
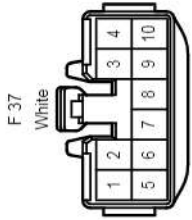

Position of Parts in Instrument Panel <RHD Front Separate Seat Type>

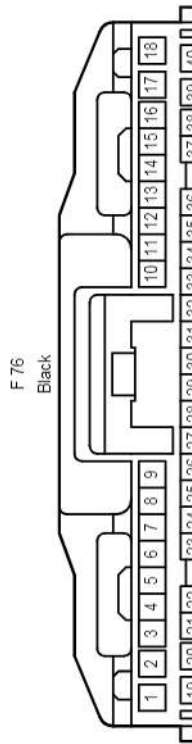
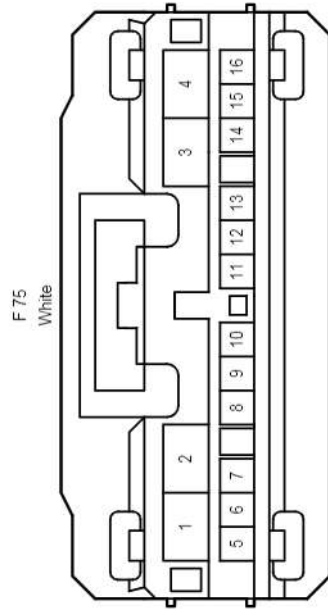
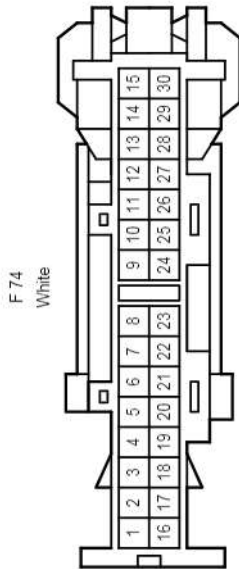
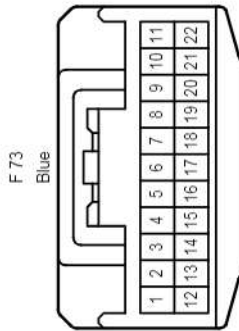
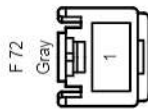
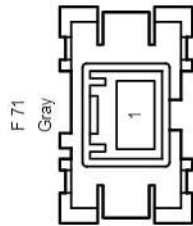
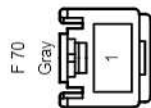
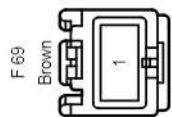
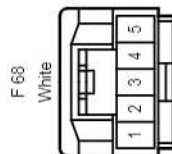
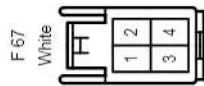
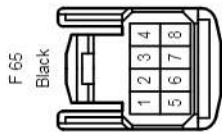
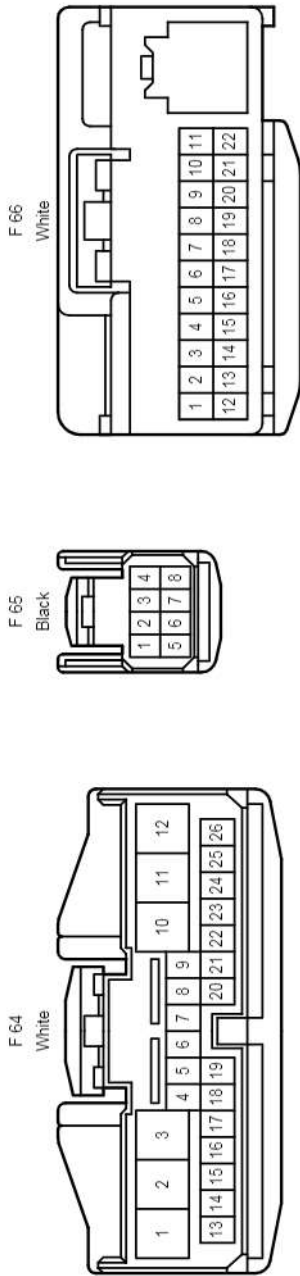

Position of Parts in Instrument Panel <RHD Front Separate Seat Type>

F 77
White

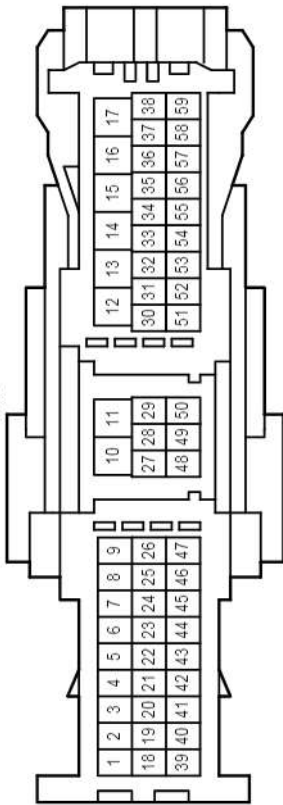

F 78
White

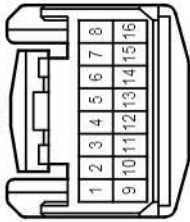

F 79
White

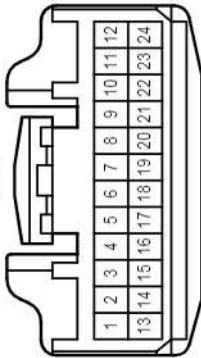

F 82
Blue

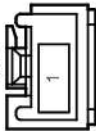

F 83
Blue

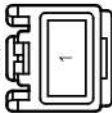

F 84
White

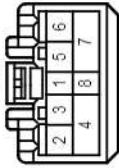

F 85
White

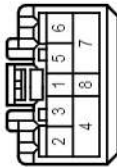

F 86
Gray

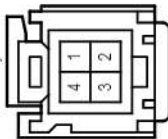

F 88
Gray

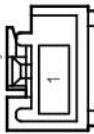

F 89
White

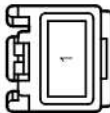

F 90
White

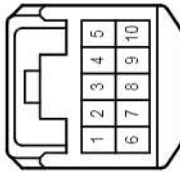

Position of Parts in Instrument Panel <RHD Front Separate Seat Type>

G	1	Outer Mirror Switch Assembly
G	2	Outer Mirror Switch Assembly
G	3	Curtain Airbag Cutoff Switch
G	4	Headlight Cleaner Switch Assembly
G	5	Back Sonar or Clearance Sonar Switch Assembly
G	7	Outer Mirror Switch Assembly
G	8	Idle Up Switch
G	9	Headlight Leveling Switch
G	12	Center Differential Lock Switch
G	13	VSC Off Switch
G	14	Steering Heater Switch
G	15	Back Sonar or Clearance Sonar Switch Assembly
G	16	Outer Mirror Switch Assembly
G	17	Headlight Leveling Switch
K	27	Center Airbag Sensor Assembly
K	32	Center Airbag Sensor Assembly
K	37	Acceleration Sensor LH
L	27	Center Airbag Sensor Assembly
L	35	Acceleration Sensor RH
L	38	Center Airbag Sensor Assembly
L	43	Option Connector (Parking Assist-Sensor)
L	44	Option Connector (Parking Assist-Sensor)
P	1	Headphone Terminal
V	1	Seat Heater Switch
V	3	Front Indoor Electrical Key Oscillator
V	4	Suspension Control Switch
V	5	Suspension Control Switch
V	6	Seat Heater Switch
b	1	Front Passenger Side Squib Circuit
b	2	Front Passenger Side Squib Circuit
b	3	Front Passenger Side Squib Circuit
b	4	Front Passenger Side Squib Circuit
e	1	Clutch Start Switch Assembly
e	2	Clutch Switch Assembly
g	1	Clock Assembly
m	1	No.1 Stereo Jack Adapter Assembly

Position of Parts in Instrument Panel <RHD Front Separate Seat Type>

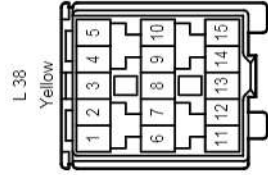
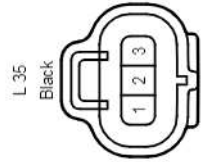
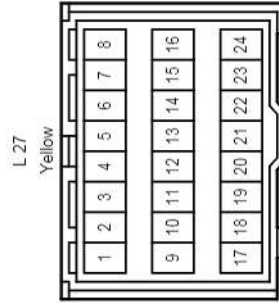
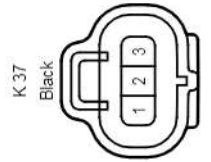
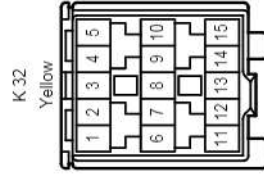
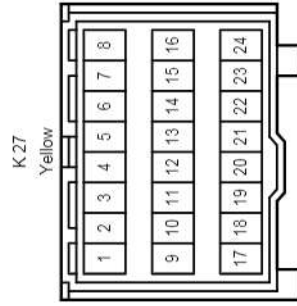
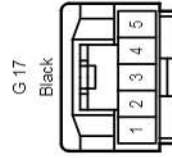
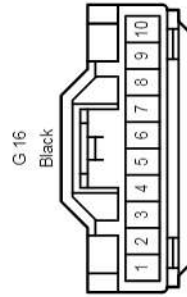
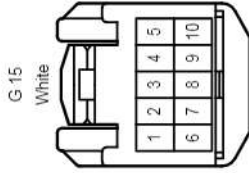
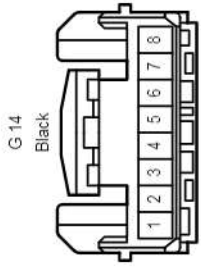
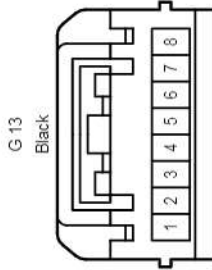
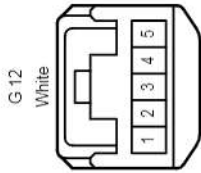
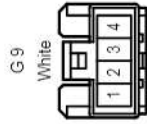
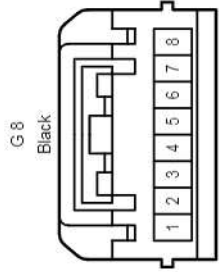
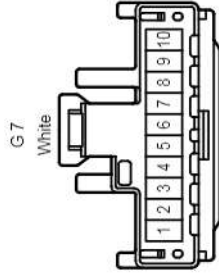
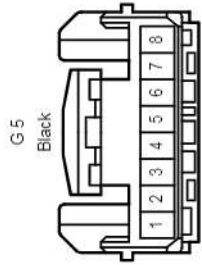
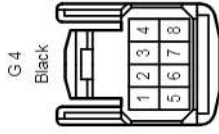
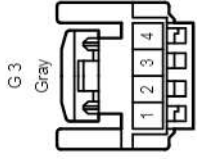
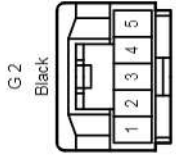
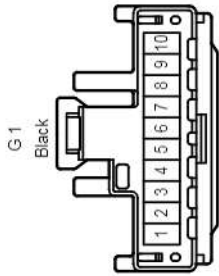

Position of Parts in Instrument Panel <RHD Front Separate Seat Type>

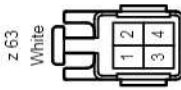
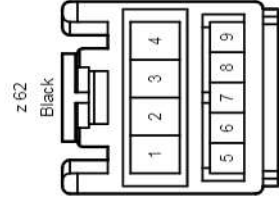
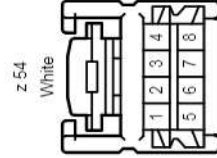
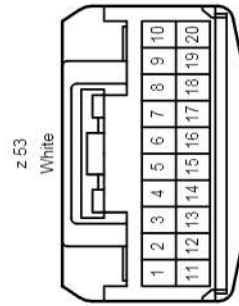
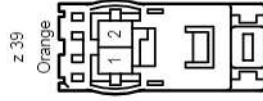
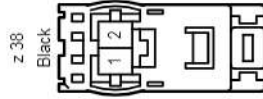
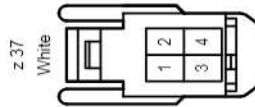
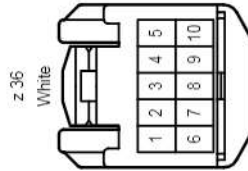
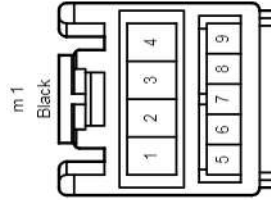
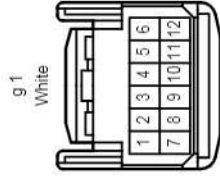
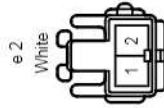
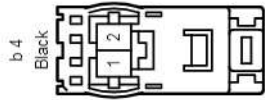
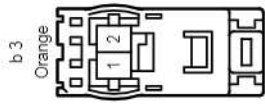
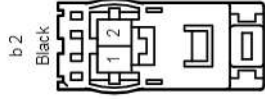
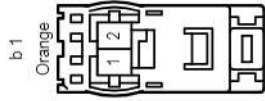
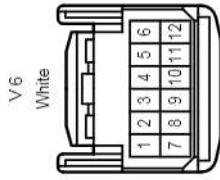
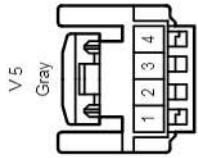
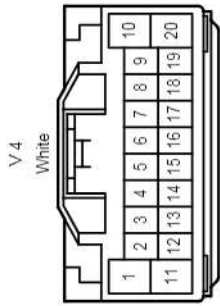

Wire and Wire in Instrument Panel <RHD Front Separate Seat Type>

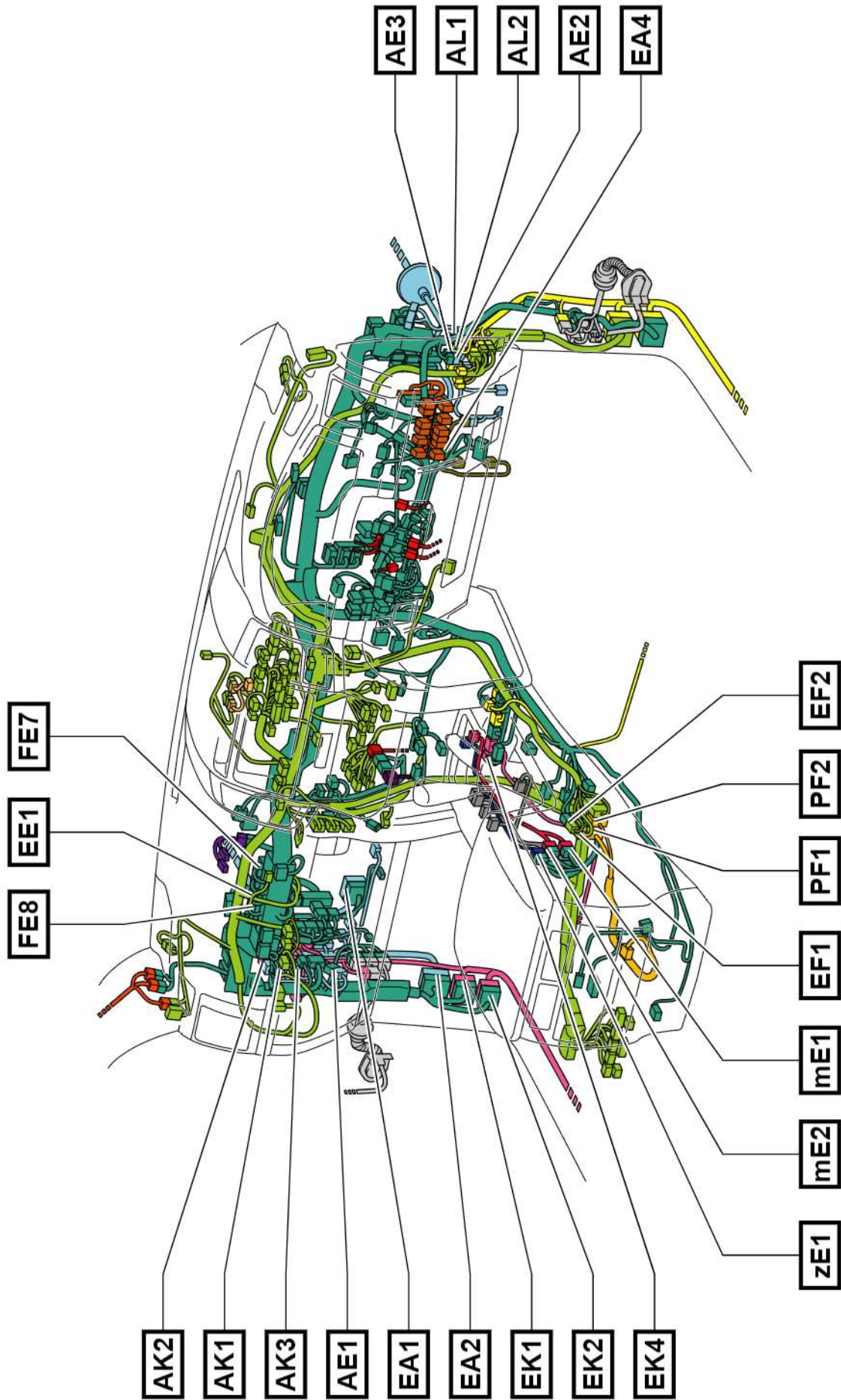

Wire and Wire in Instrument Panel <RHD Front Separate Seat Type>

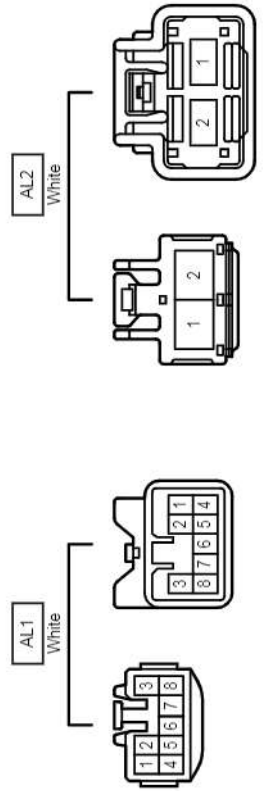
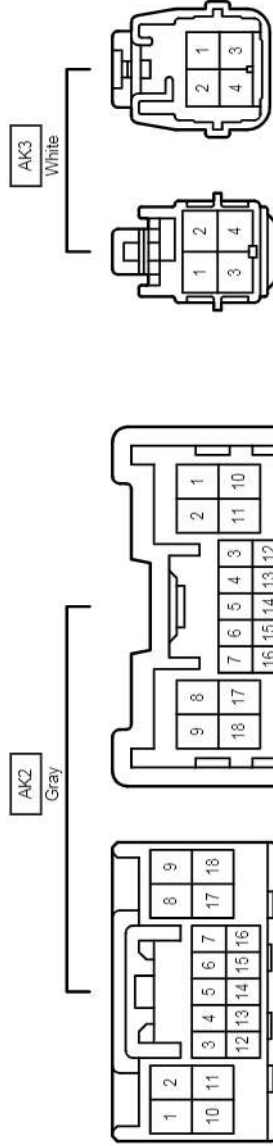
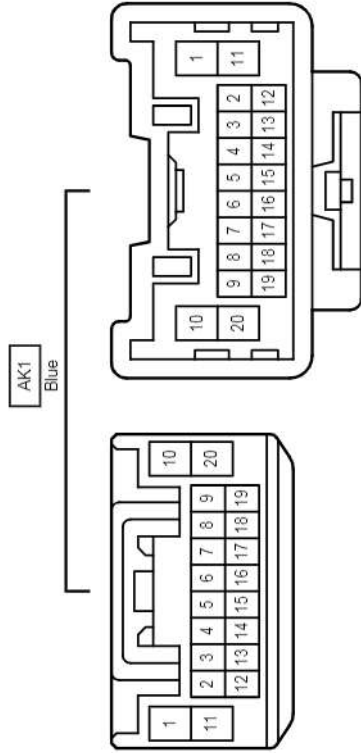
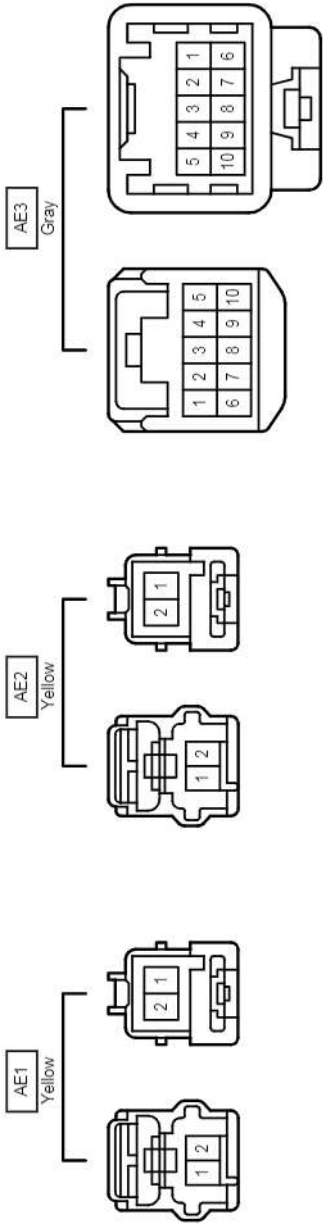

Wire and Wire in Instrument Panel <RHD Front Separate Seat Type>

EA1
White

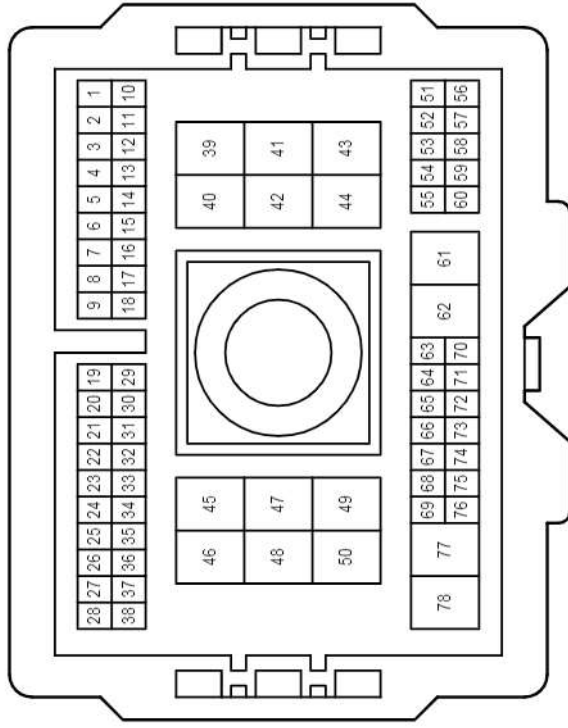
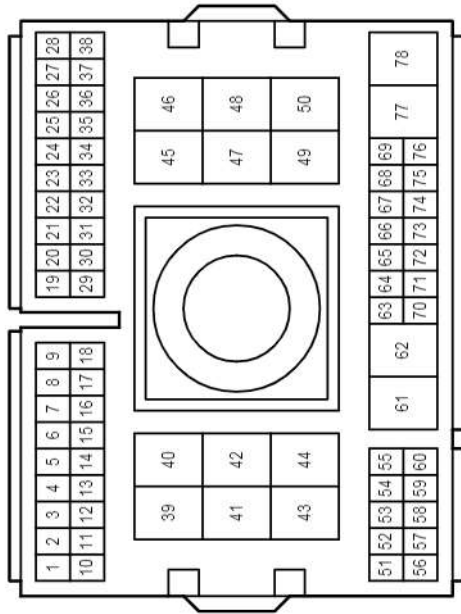

EA2
Gray

EA2
Gray

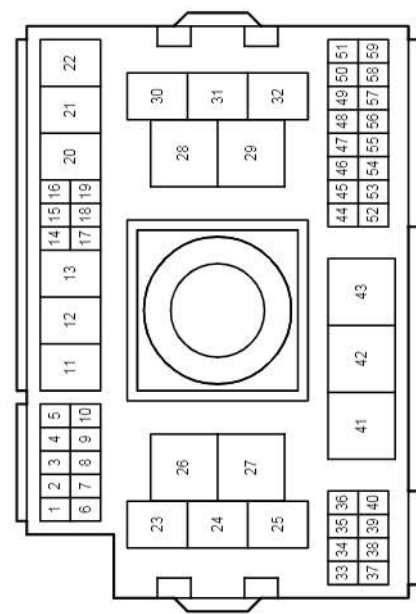

EA4
White

EA4
White

Wire and Wire in Instrument Panel <RHD Front Separate Seat Type>

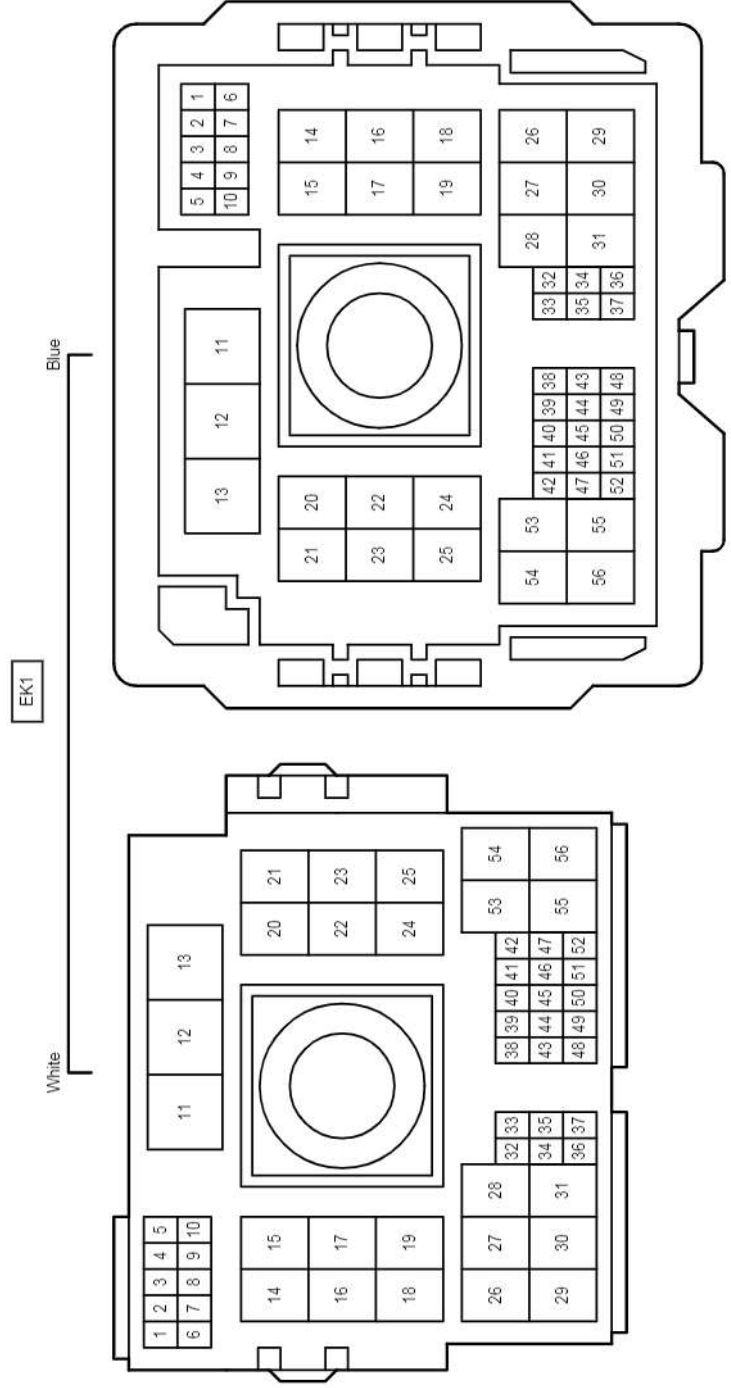
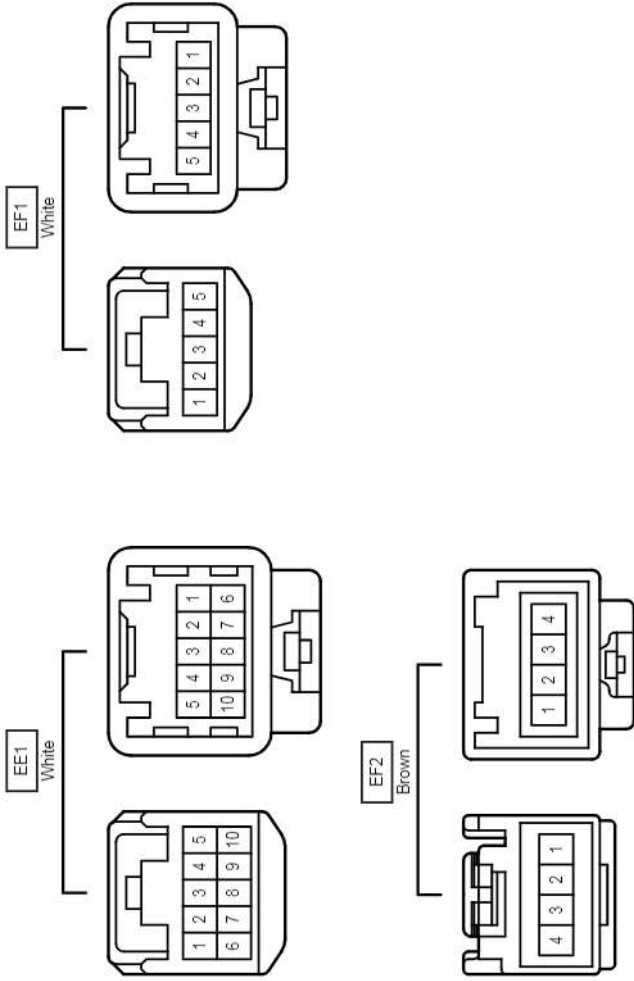

Wire and Wire in Instrument Panel <RHD Front Separate Seat Type>

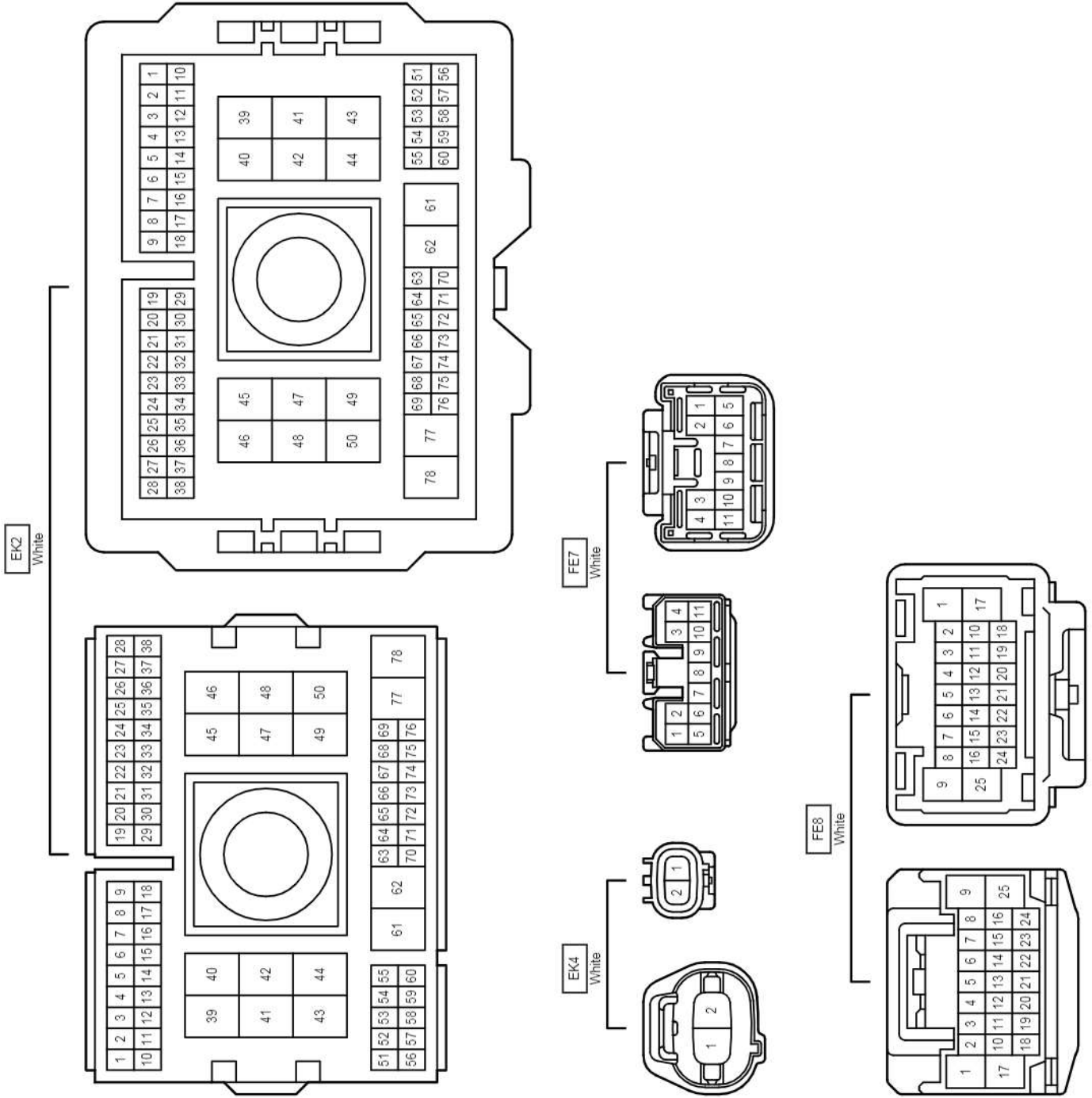

Wire and Wire in Instrument Panel <RHD Front Separate Seat Type>

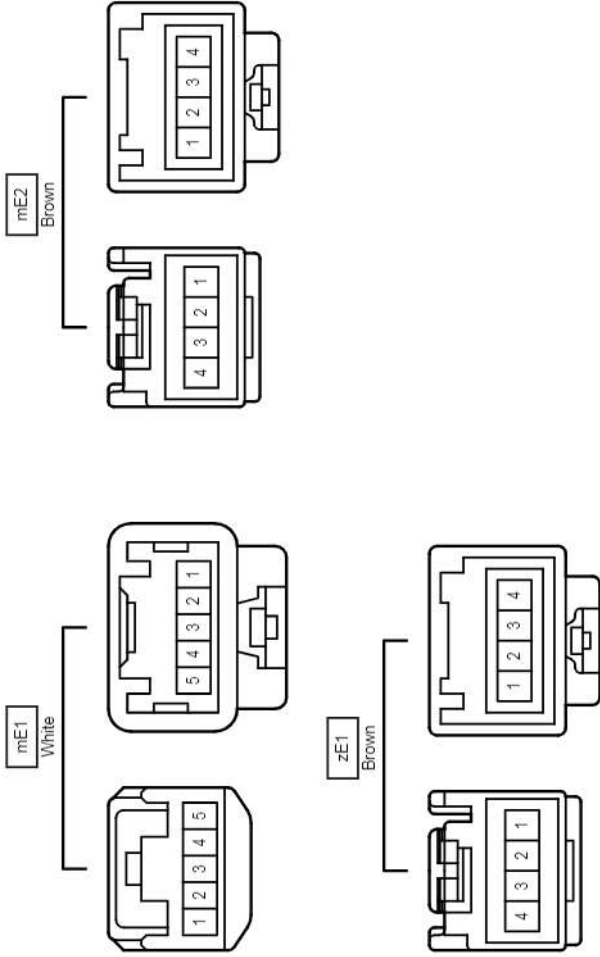

Wire and Wire in Instrument Panel <RHD Front Separate Seat Type>

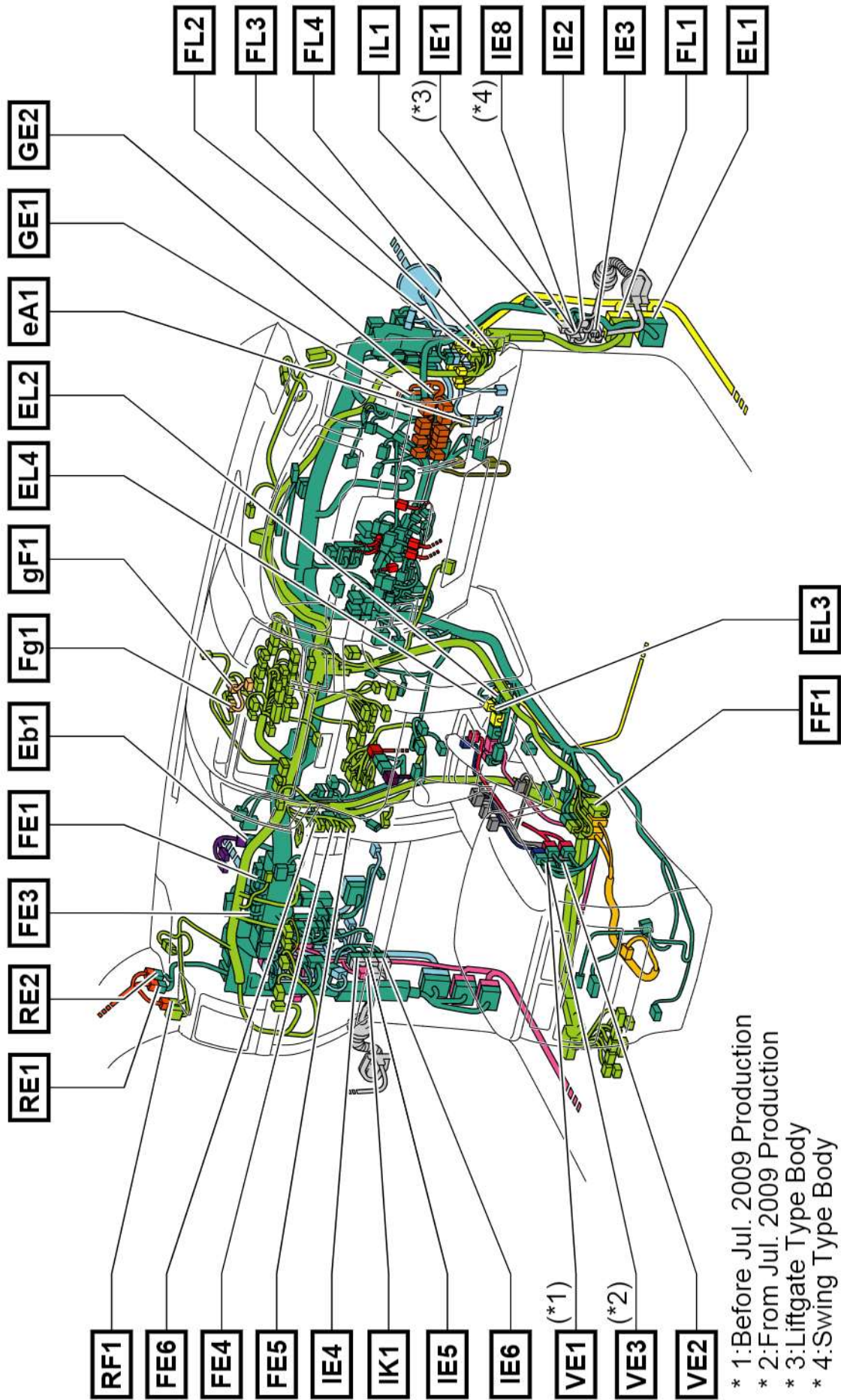

- * 1: Before Jul. 2009 Production
- * 2: From Jul. 2009 Production
- * 3: Liftgate Type Body
- * 4: Swing Type Body

Wire and Wire in Instrument Panel <RHD Front Separate Seat Type>

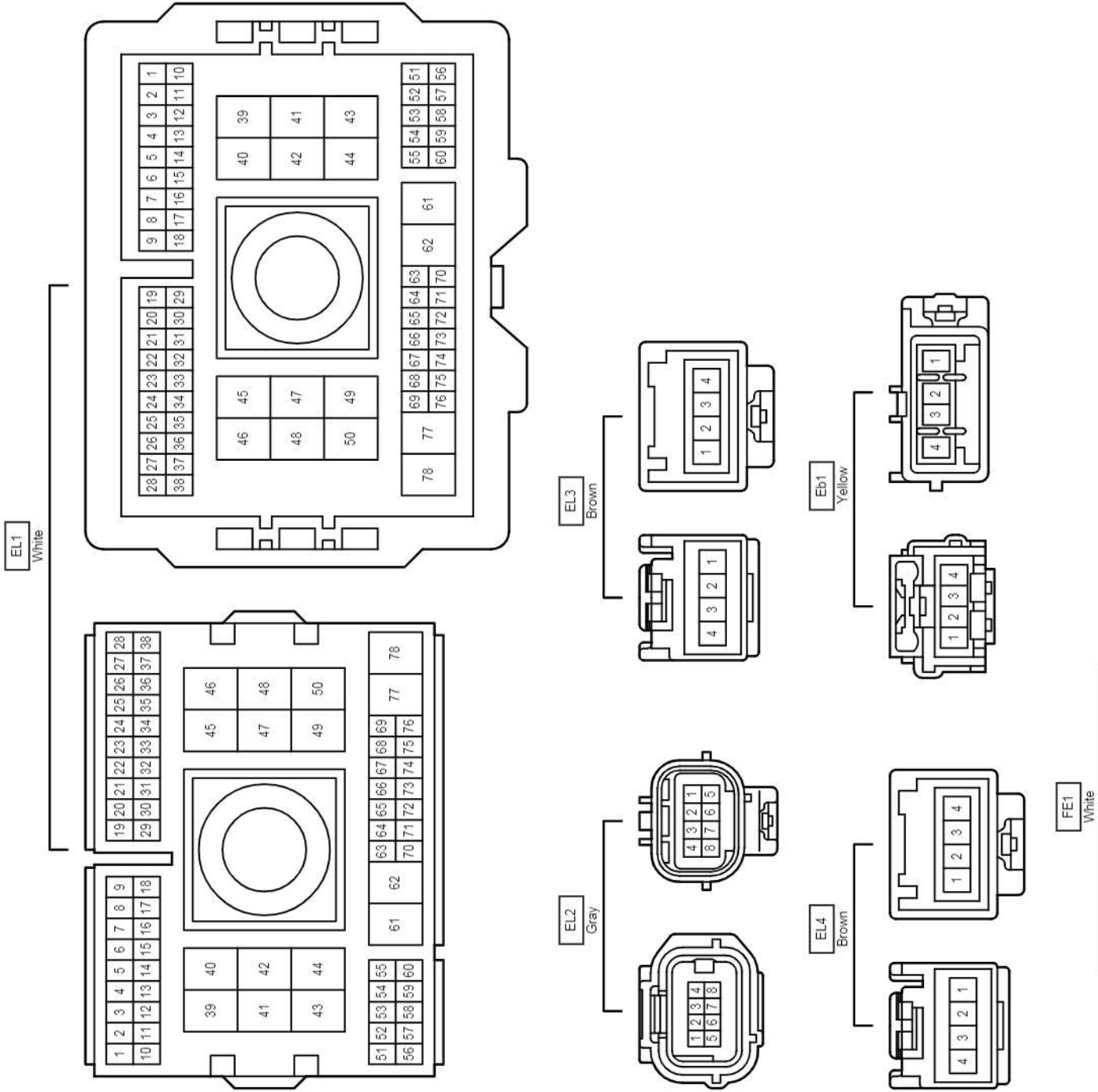

Wire and Wire in Instrument Panel <RHD Front Separate Seat Type>

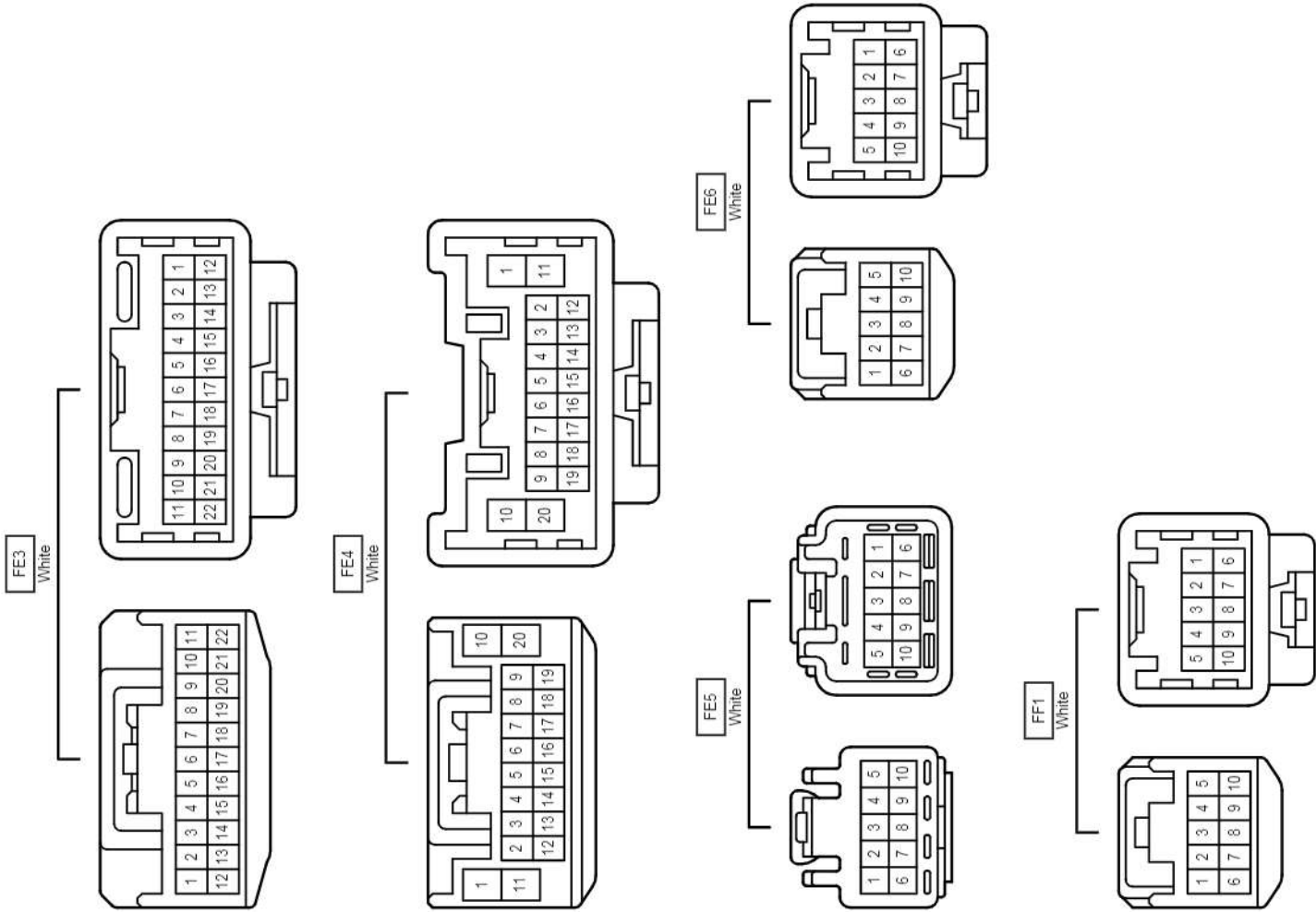

Wire and Wire in Instrument Panel <RHD Front Separate Seat Type>

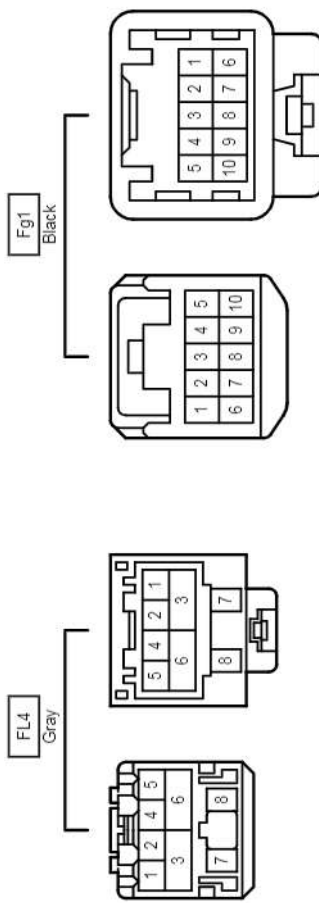
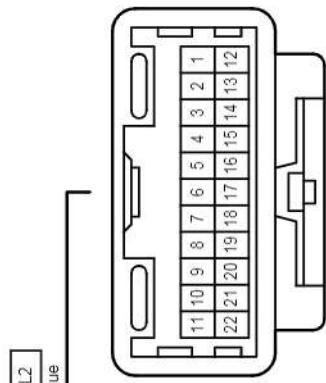
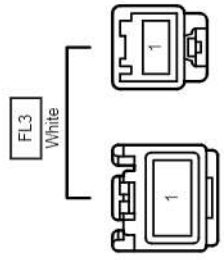
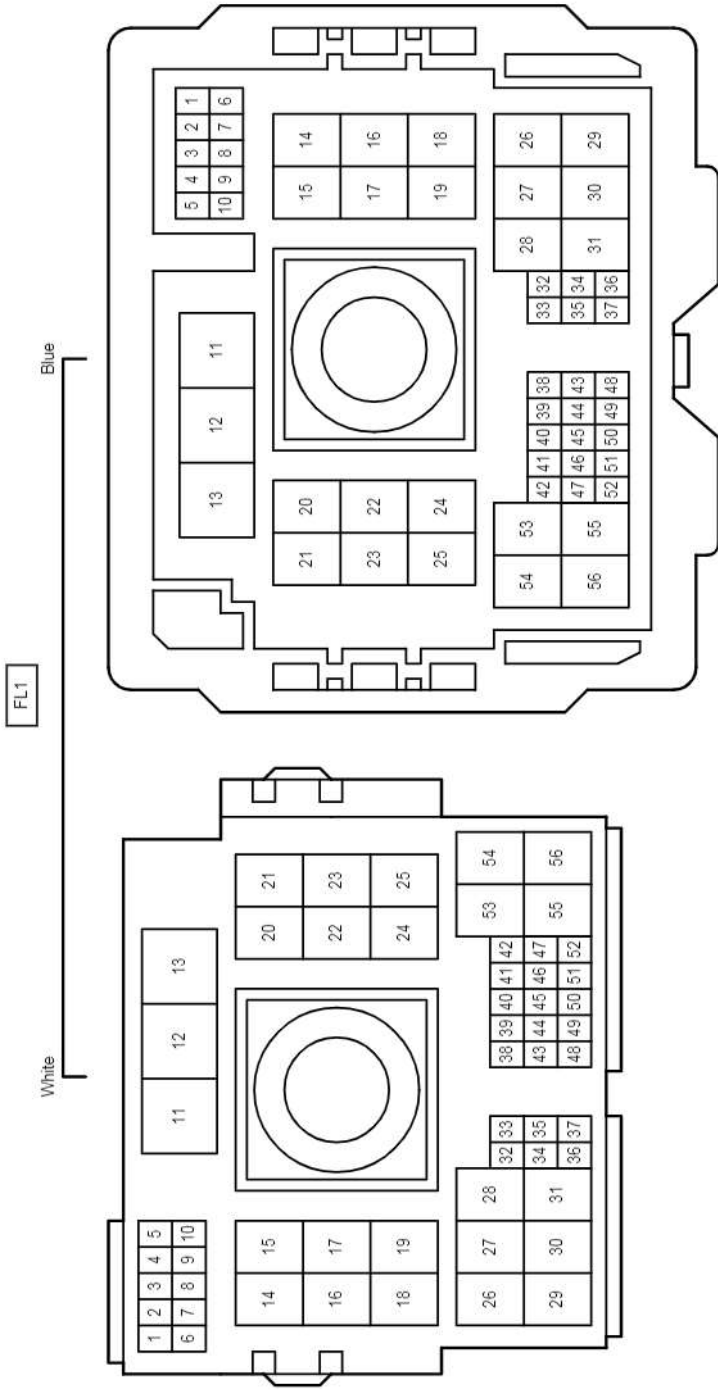

cardiagn.com

Wire and Wire in Instrument Panel <RHD Front Separate Seat Type>

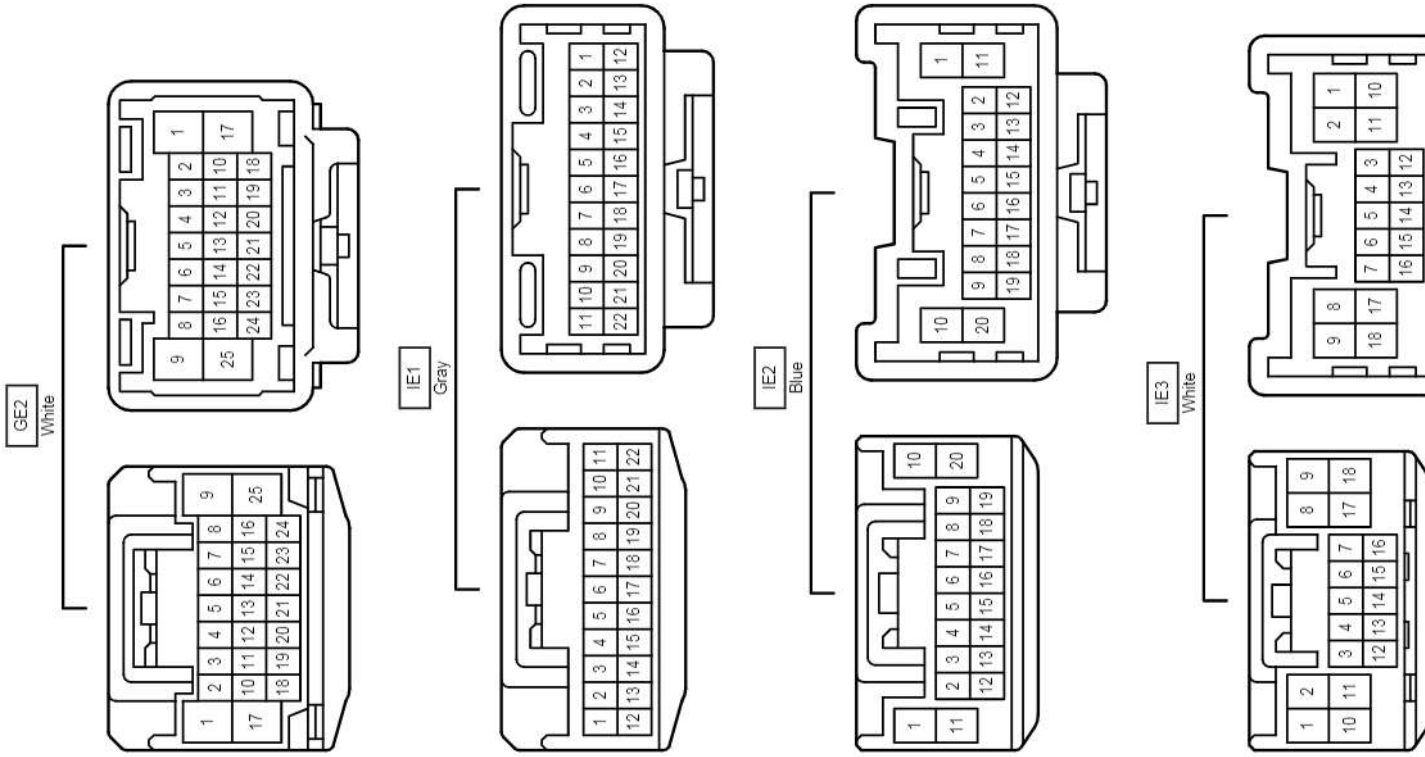

Wire and Wire in Instrument Panel <RHD Front Separate Seat Type>

IE5
Blue

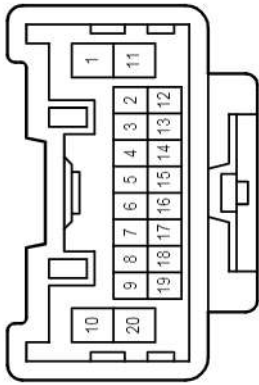
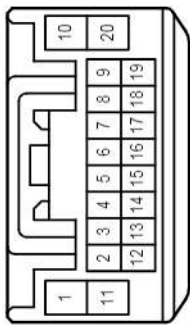

IE6
White

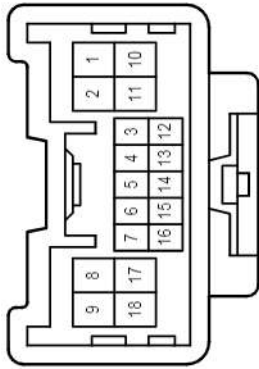
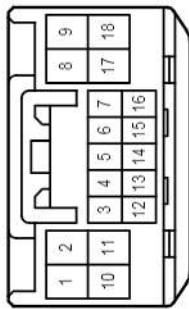

IE8
White

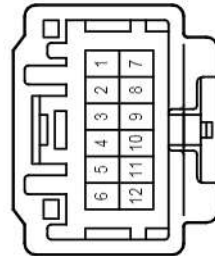
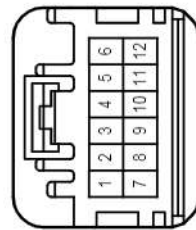

IK1
Yellow

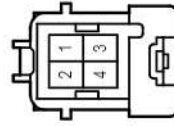
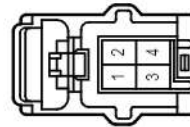

IL1
Yellow

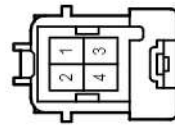
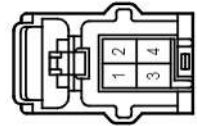

RE1
White

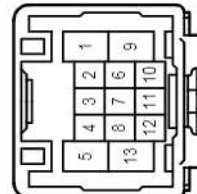
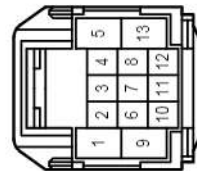

Wire and Wire in Instrument Panel <RHD Front Separate Seat Type>

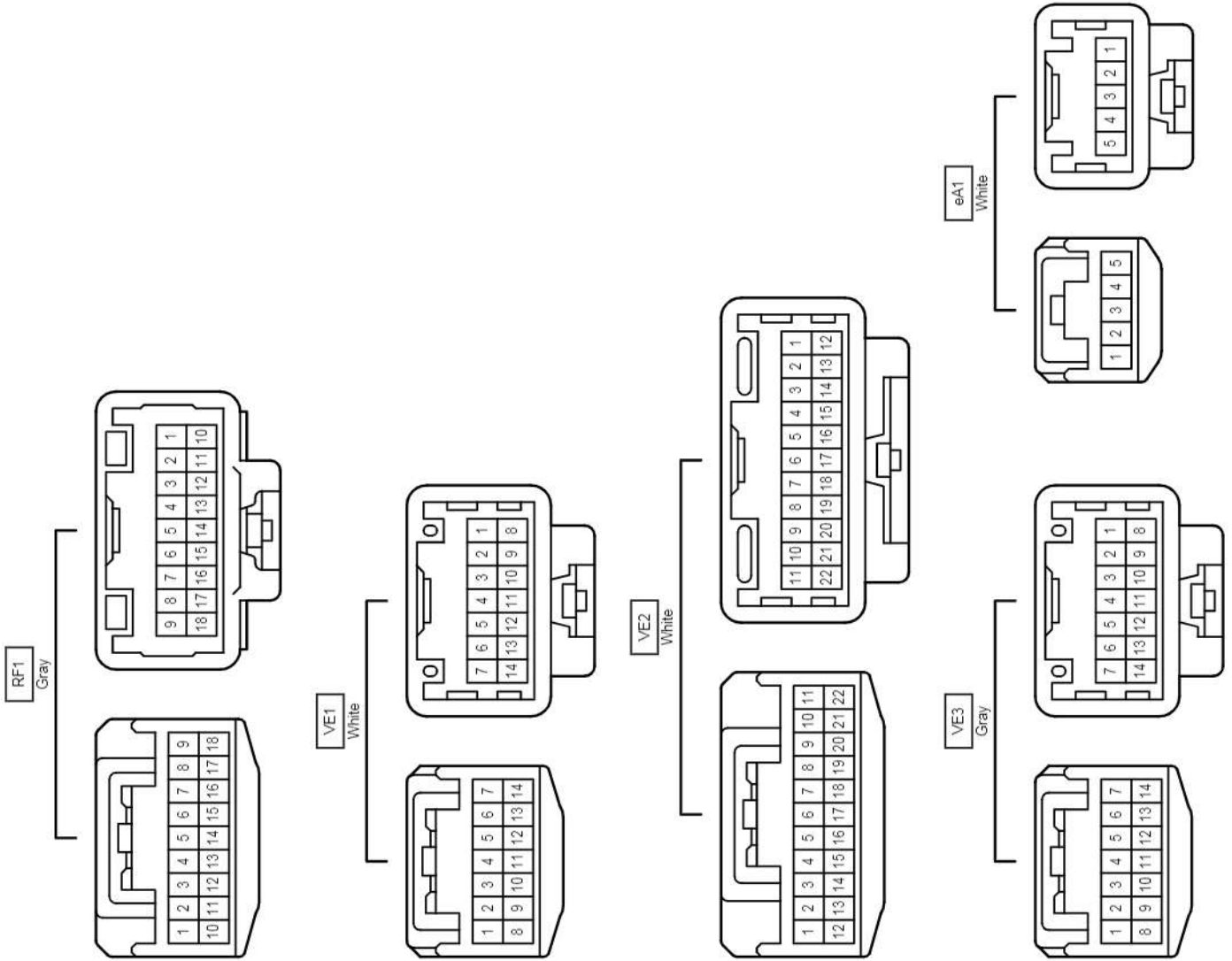

Antenna , Antenna in Antenna <LHD Liffgate Type>

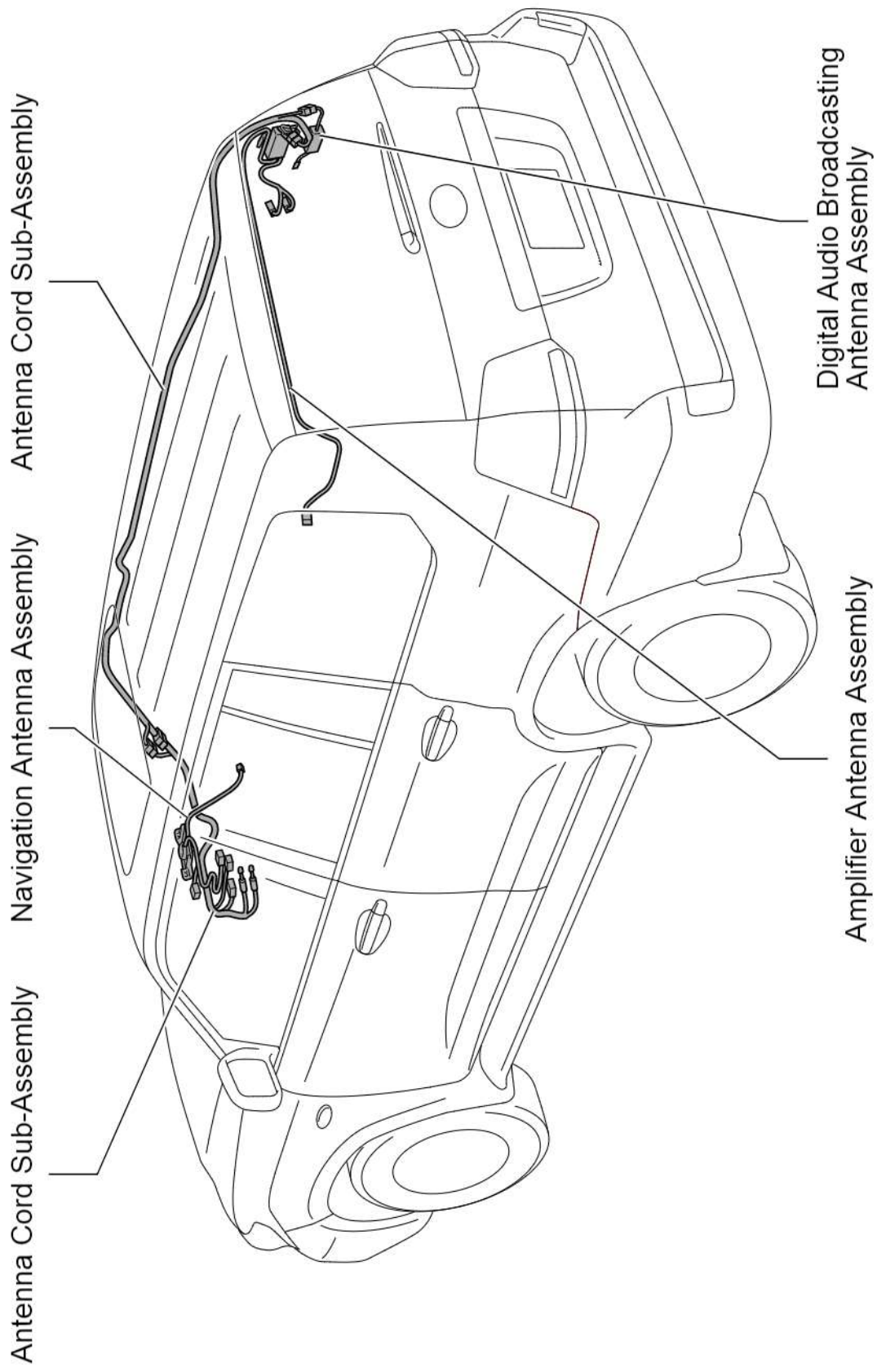

Antenna , Antenna in Antenna <RHD Liffgate Type>

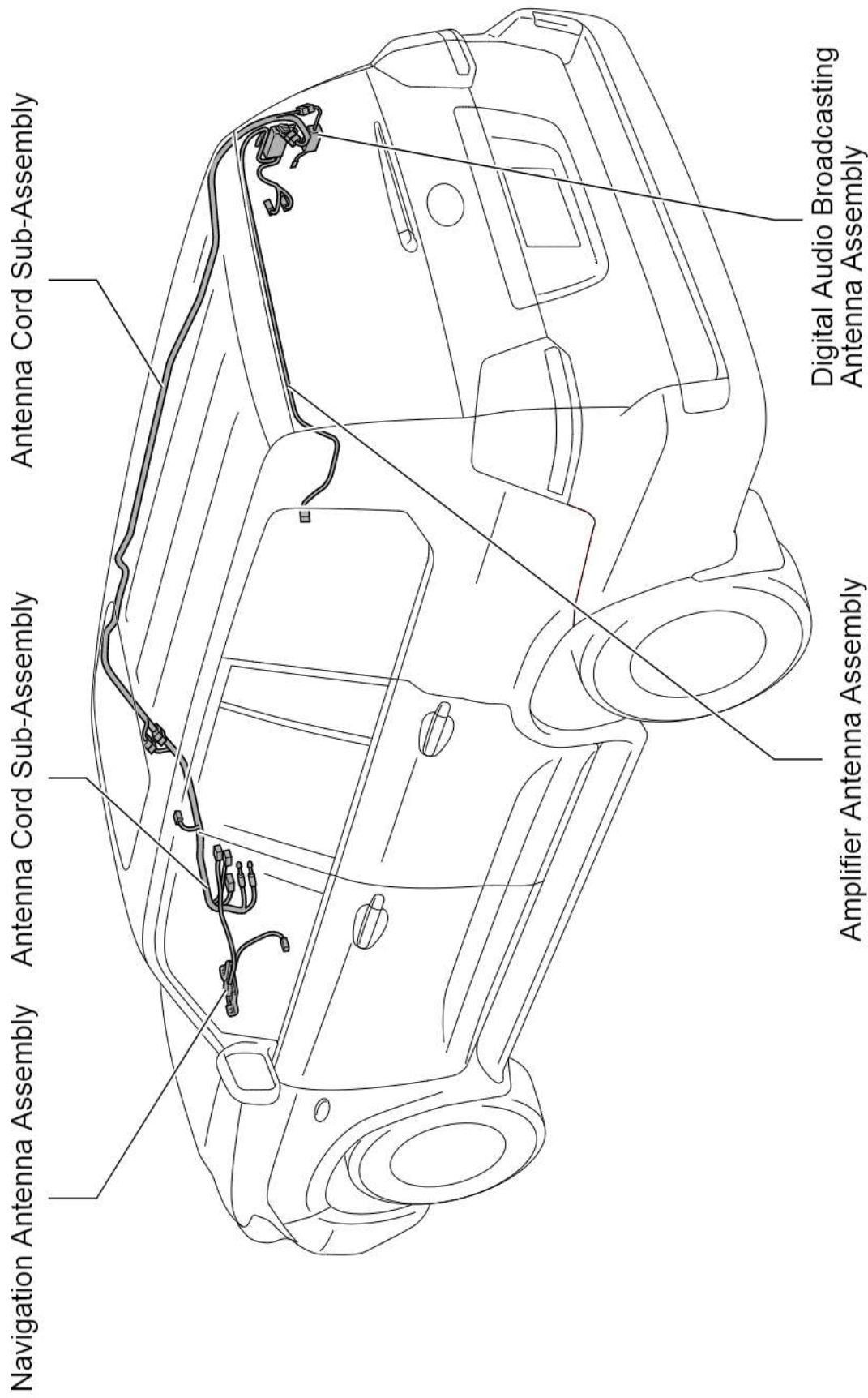

Ground Points in Body <LHD Liftgate Type>

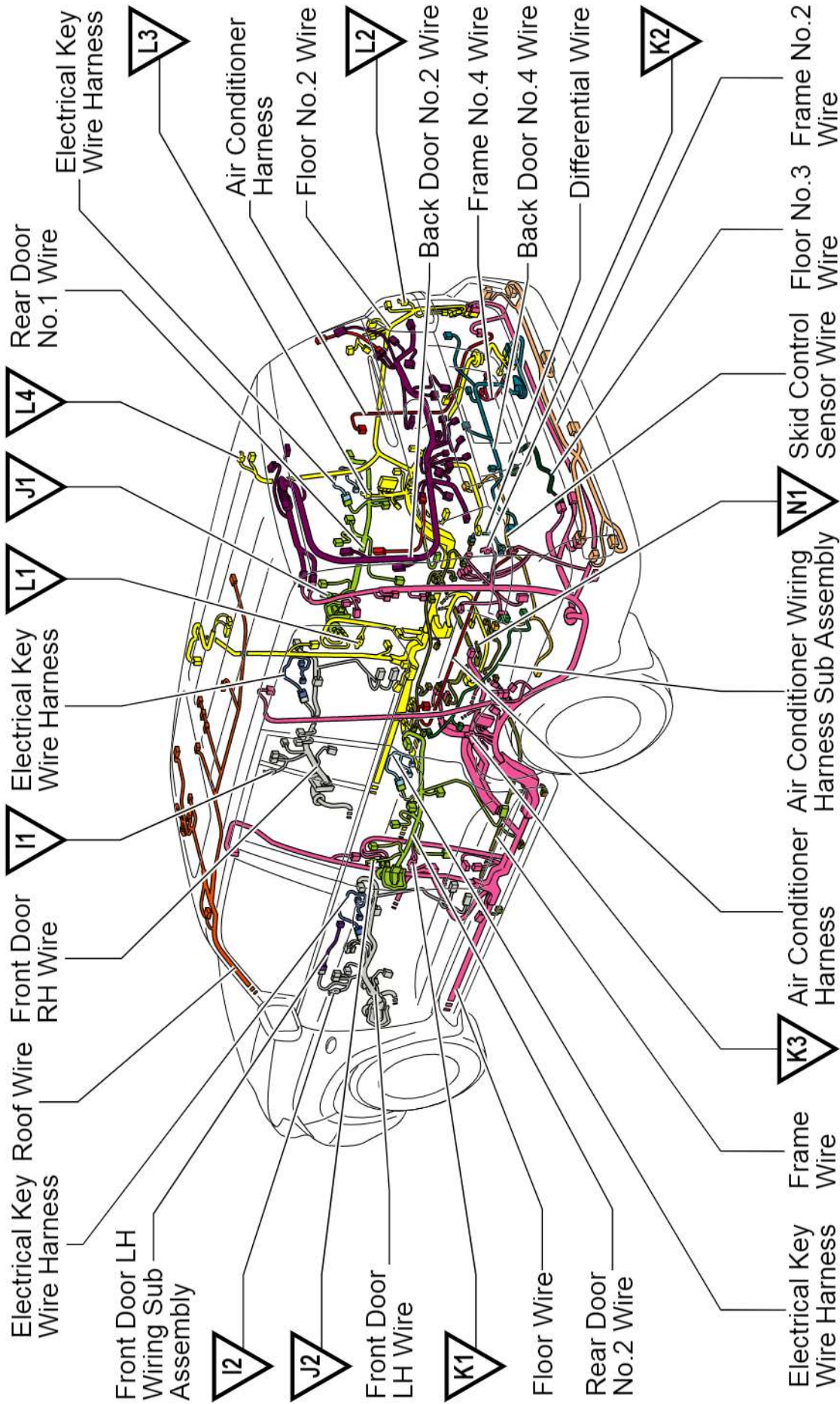

Position of Parts in Body <LHD Liftgate Type>

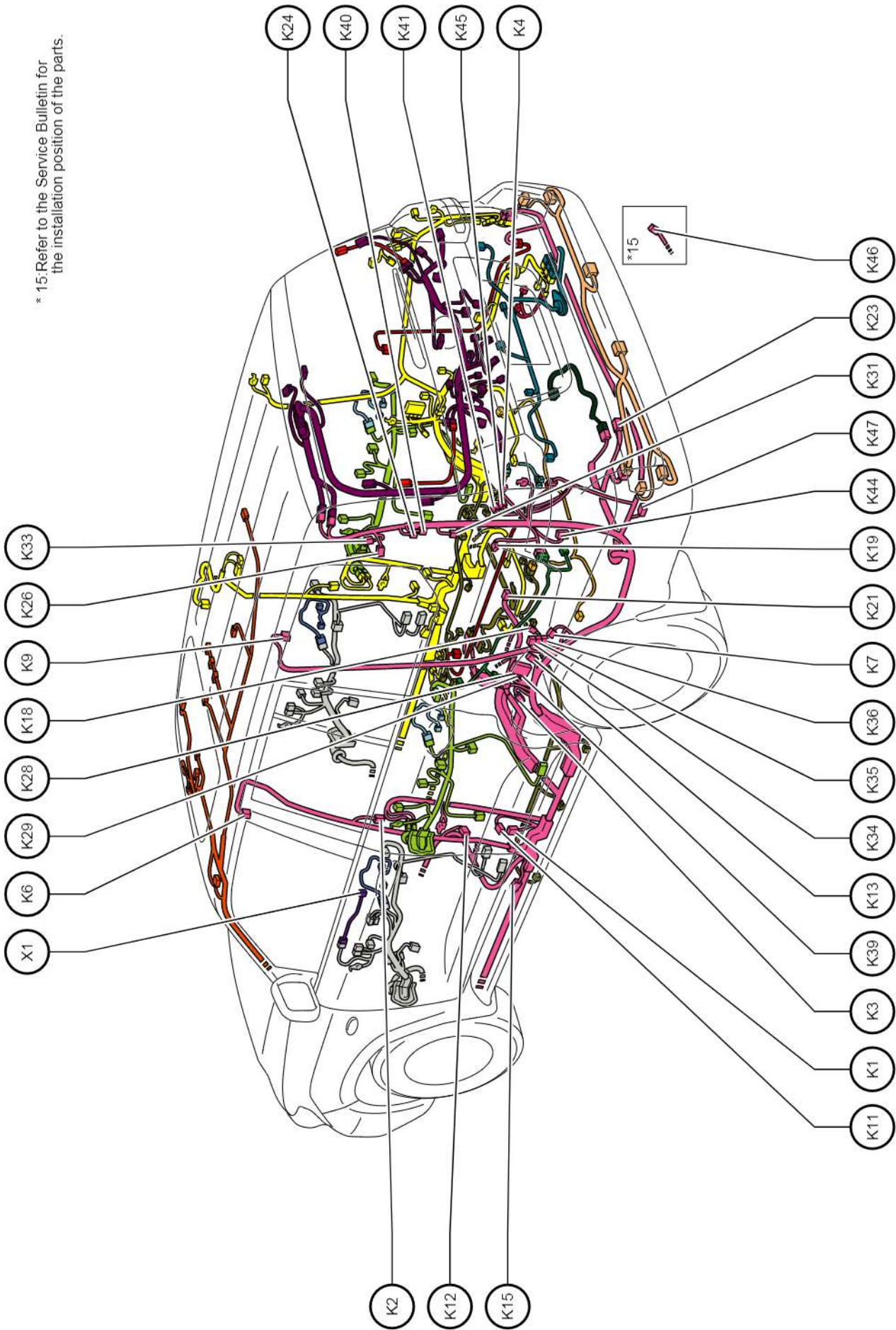

* 15: Refer to the Service Bulletin for the installation position of the parts.

K	1	Front Pretensioner LH
K	2	Front Door Courtesy Light Switch Assembly LH
K	3	Rear Door Courtesy Light Switch Assembly LH
K	4	Rear Combination Light Assembly LH
K	6	Curtain Shield Airbag Assembly Circuit LH
K	7	Rear Side Airbag Sensor Assembly LH
K	9	Curtain Shield Airbag Assembly Circuit LH
K	11	Front Pre-Crash Seat Belt Motor LH
K	12	Front Tension Reducer LH
K	13	Rear Pretensioner LH
K	15	No.2 Interior Illumination Light Assembly
K	18	Theft Warning Siren Assembly
K	19	Rear A/C Blower Assembly
K	21	Cooler Thermistor LH
K	23	Outside Luggage Electrical Key Antenna
K	24	Towing Converter
K	26	Glass Breakage Sensor (Quarter Glass LH)
K	28	Junction Connector
K	29	Junction Connector
K	31	Diode (Rear Cooler)
K	33	Diode (Stop Light)
K	34	Suspension Control ECU
K	35	Suspension Control ECU
K	36	Suspension Control ECU
K	39	Junction Connector
K	40	Towing Converter
K	41	Rear Power Outlet Socket Assembly
K	44	Voltage Inverter Assembly
K	45	Power Outlet Socket Assembly
K	46	Theft Warning Siren Assembly
K	47	Power Back Door Warning Buzzer
X	1	Seat Memory Switch LH

Position of Parts in Body <LHD Liftgate Type>

K 1
Yellow

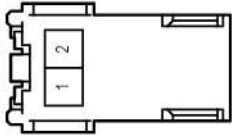

K 2
White



K 3
White



K 4
White

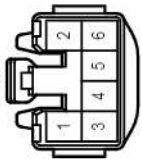

K 6
Black

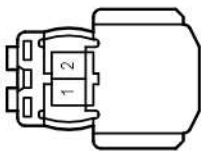

K 7
Yellow

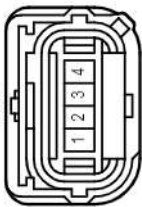

K 9
Black

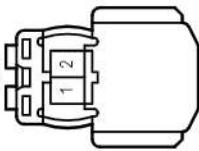

K 11
White

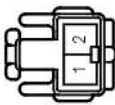

K 12
White



K 13
Yellow

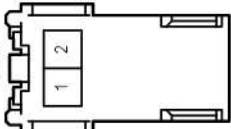

K 15
White



K 18
Gray



K 19
White

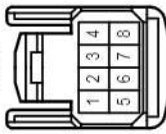

K 21
Black

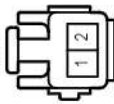

K 23
White

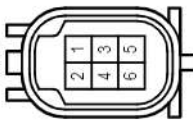

K 24
White

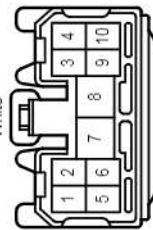

K 26
White

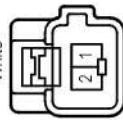

K 28
White



K 29
White

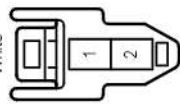

K 31
White



K 33
White



K 34
Black

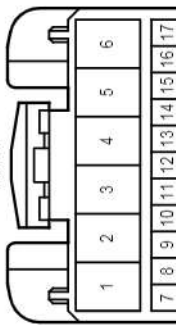

K 35
Black

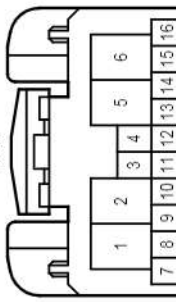

K 36
Black

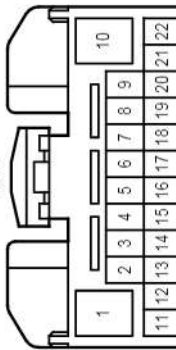

Position of Parts in Body <LHD Liftgate Type>

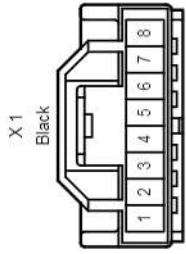
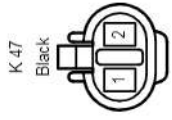
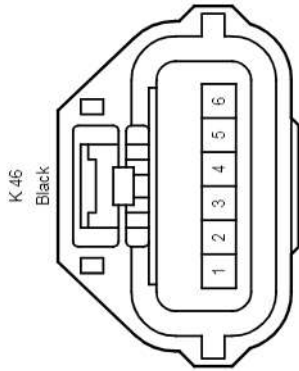

Position of Parts in Body <LHD Liftgate Type>

L	1	Front Door Courtesy Light Switch Assembly RH
L	2	Rear Door Courtesy Light Switch Assembly RH
L	3	Rear Combination Light Assembly RH
L	4	No.1 with Box Speaker Assembly
L	5	Front Pre-Crash Seat Belt Motor RH
L	6	Front Tension Reducer RH
L	8	Rear Indoor Electrical Key Oscillator
L	9	Indoor Luggage Compartment Electrical Key Oscillator
L	12	Cooler Thermistor RH
L	13	Front Pretensioner RH
L	14	Rear Pretensioner RH
L	17	Curtain Shield Airbag Assembly Circuit RH
L	18	Rear Side Airbag Sensor Assembly RH
L	19	Rear Floor Side Airbag Sensor
L	20	Curtain Shield Airbag Assembly Circuit RH
L	21	Door Control Receiver
L	29	Junction Connector
L	30	Junction Connector
L	32	No.1 Interior Illumination Light Assembly RH
L	34	Glass Breakage Sensor (Quarter Glass RH)
L	36	Height Control Pump and Motor Assembly
L	37	Option Connector (Theft Warning Radar Sensor)
L	40	Multi-Media Interface ECU Assembly
L	41	Multi-Media Interface ECU Assembly
L	44	Option Connector (Parking Assist-Sensor)
L	45	Multi-Media Interface ECU Assembly
L	50	No.2 Multiplex Network Body ECU
L	51	No.2 Multiplex Network Body ECU
L	52	Power Back Door Unit Assembly
L	53	Television Display Assembly
L	54	Junction Connector
L	55	Multi-Media Interface ECU Assembly
L	56	Television Display Assembly
L	57	Junction Connector
R	1	Visor Assembly LH
R	2	Inner Rear View Mirror Assembly
R	3	Visor Assembly RH
R	4	No.2 Room Light Assembly
R	5	Sliding Roof Control ECU
R	6	No.3 Room Light Assembly
R	7	Overhead Module
R	8	No.2 Room Light Assembly
R	9	No.2 Room Light Assembly

Position of Parts in Body <LHD Liftgate Type>

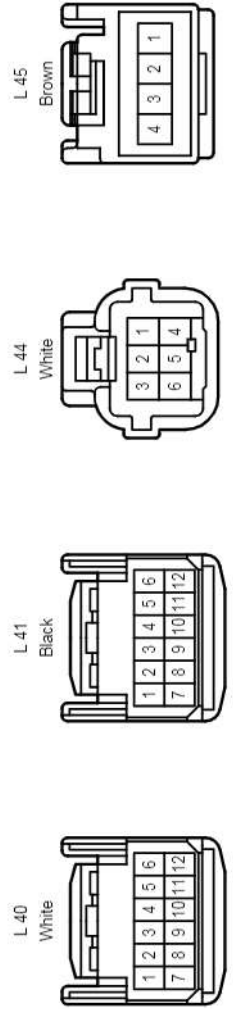
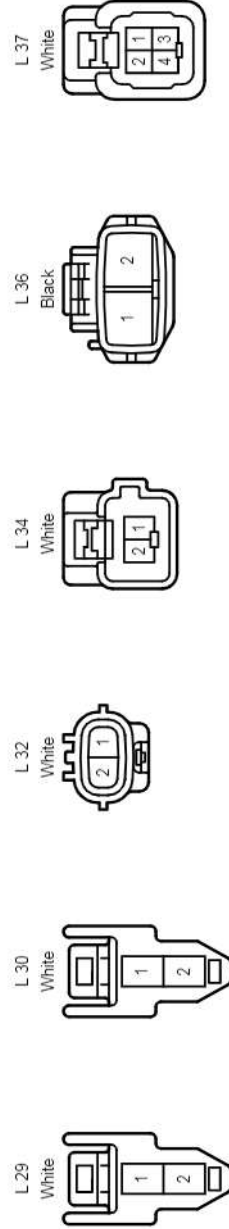
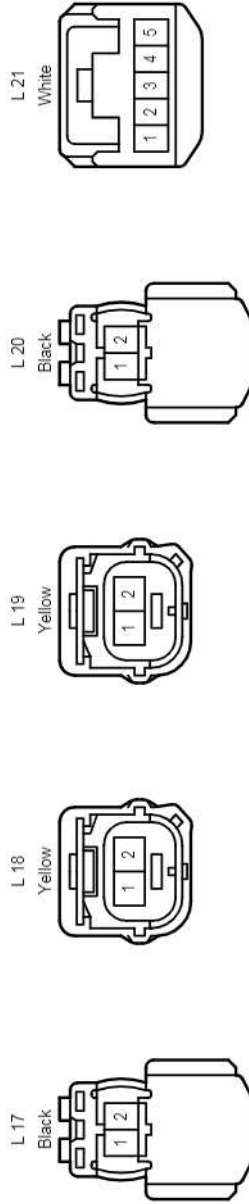
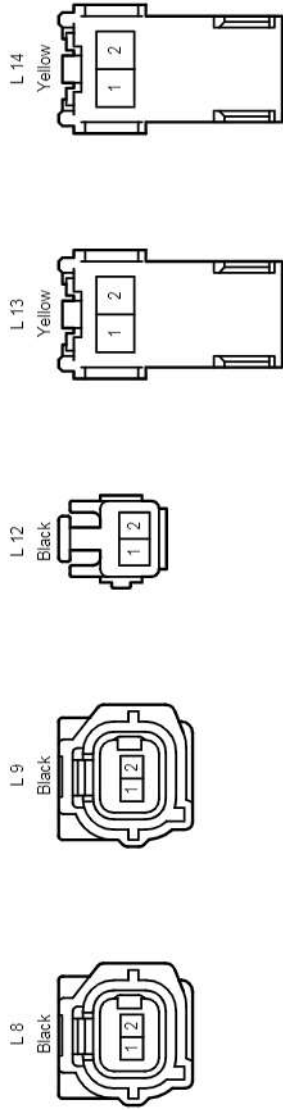
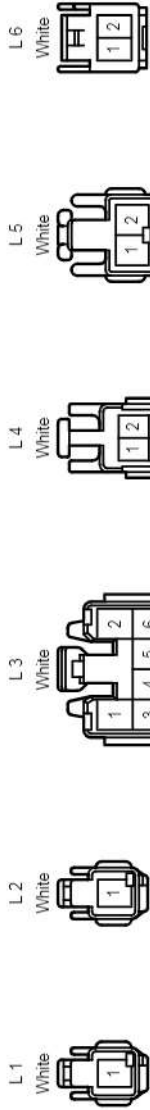

L 50 White

L 51 Blue

Position of Parts in Body <LHD Liftgate Type>

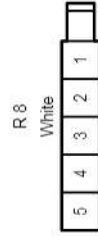
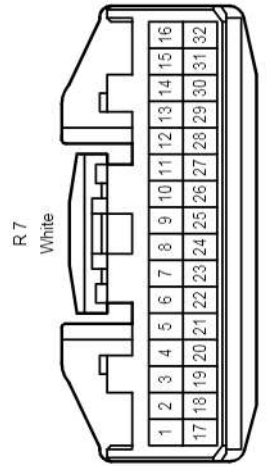
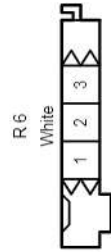
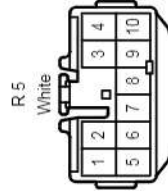
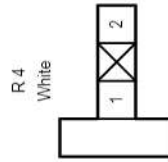
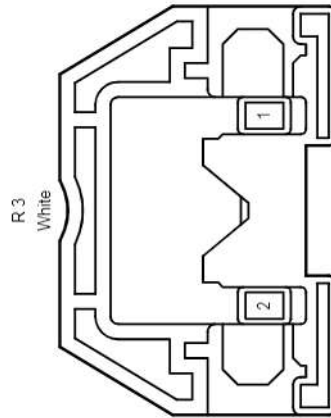
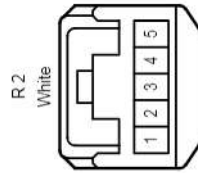
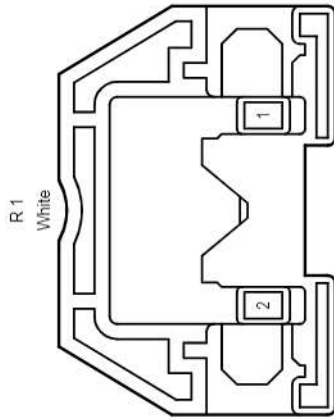
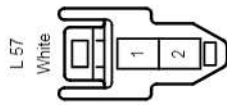
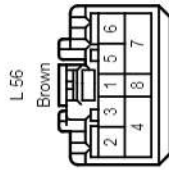
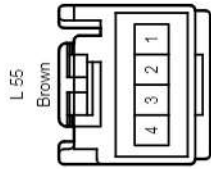
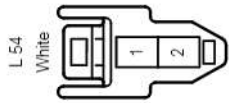
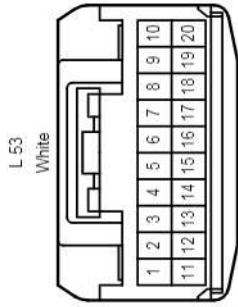
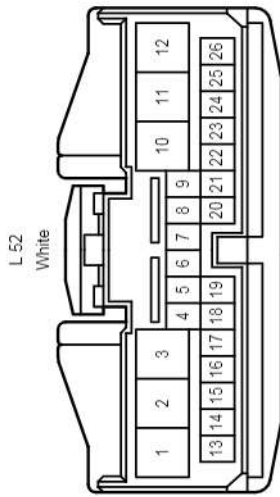

R9 White

R10 White

R11 Black

R12 White

Position of Parts in Body <LHD Liftgate Type>

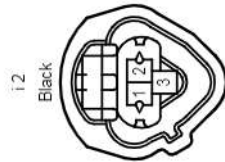
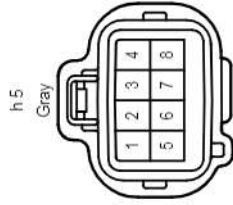
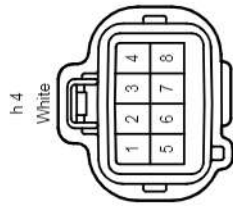
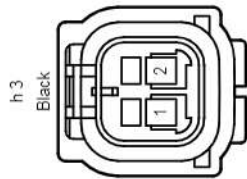
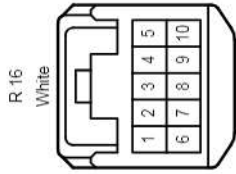
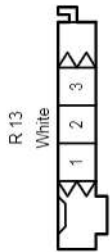

Position of Parts in Body <LHD Liftgate Type>

I	1	Front No.1 Speaker Assembly RH
I	3	Front Power Window Regulator Switch Assembly RH
I	4	Front Power Window Regulator Motor Assembly RH
I	5	Front Door Courtesy Light Assembly RH
I	6	Front Door Lock Assembly RH
I	7	Outer Rear View Mirror Assembly RH
I	8	Diode (Front Door Courtesy Switch RH)
I	9	Front Side Airbag Sensor Assembly RH
I	10	Front No.1 Speaker Assembly LH
I	11	Multiplex Network Master Switch Assembly
I	12	Front Power Window Regulator Motor Assembly LH
I	13	Front Door Courtesy Light Assembly LH
I	14	Front Door Lock Assembly LH
I	15	Outer Rear View Mirror Assembly LH
I	16	Diode (Front Door Courtesy Switch LH)
I	17	Outer Mirror Control ECU Assembly
I	18	Outer Mirror Control ECU Assembly
I	19	Front Side Airbag Sensor Assembly LH
I	20	Outer Rear View Mirror Assembly RH
I	21	Outer Rear View Mirror Assembly LH
I	31	Multiplex Network Master Switch Assembly
I	32	Outer Rear View Mirror Assembly RH
I	33	Front Door Control Switch Assembly RH
I	35	Outer Rear View Mirror Assembly LH
J	2	Rear No.3 Speaker Assembly RH
J	3	Rear Power Window Regulator Switch Assembly RH
J	4	Rear Power Window Regulator Motor Assembly RH
J	5	Rear Door Courtesy Light Assembly RH
J	6	Rear Door Lock Assembly RH
J	7	Diode (Rear Door Courtesy Switch RH)
J	9	Rear No.3 Speaker Assembly LH
J	10	Rear Power Window Regulator Switch Assembly LH
J	11	Rear Power Window Regulator Motor Assembly LH
J	12	Rear Door Courtesy Light Assembly LH
J	13	Rear Door Lock Assembly LH
J	14	Diode (Rear Door Courtesy Switch LH)
J	15	Rear Speaker Set RH
J	17	Rear Speaker Set LH
J	18	Rear Speaker Set RH
J	19	Rear Speaker Set LH
M	2	Fuel Sender Gage Assembly (Sub)

Position of Parts in Body <LHD Liftgate Type>

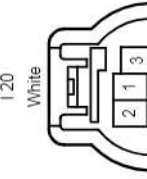
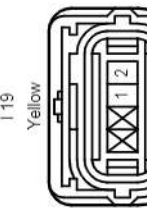
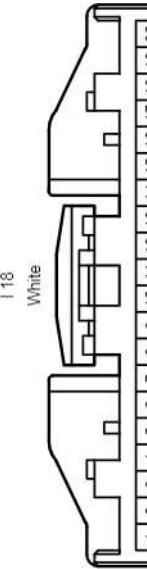
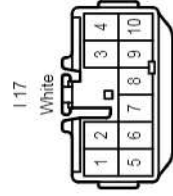
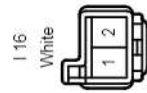
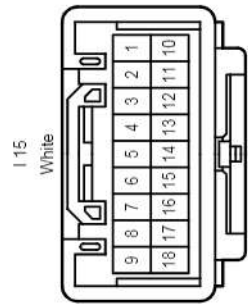
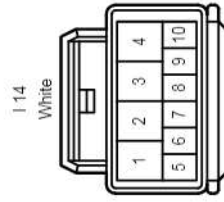
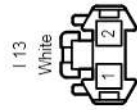
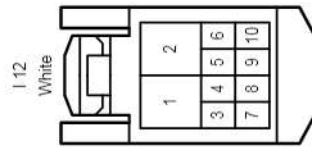
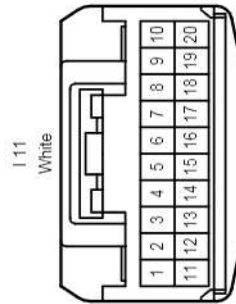
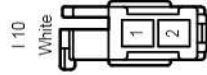
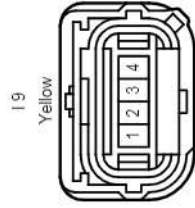
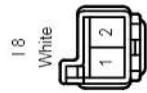
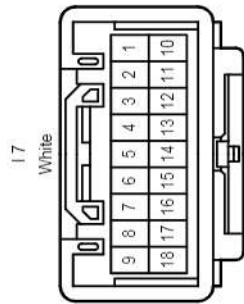
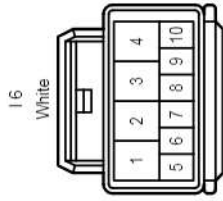
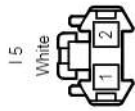
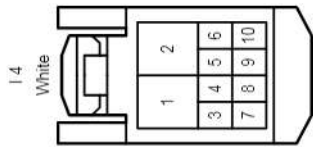
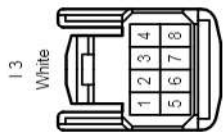
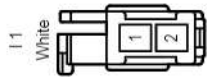

Position of Parts in Body <LHD Liftgate Type>

I 21
White

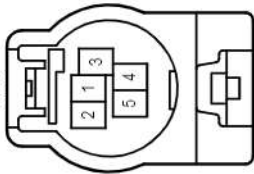

I 31
White

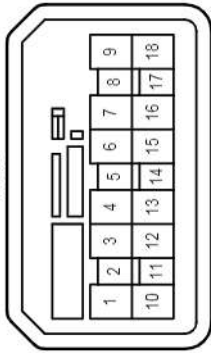

I 32
White

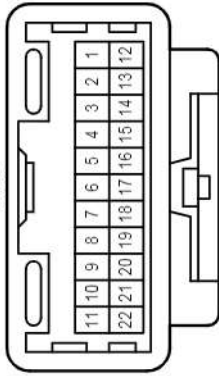

I 33
Blue



I 35
White

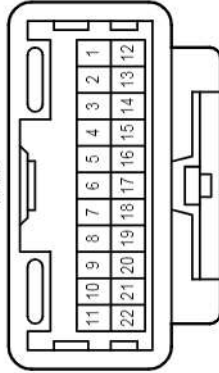

J 2
Black

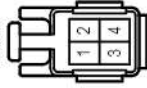

J 3
White

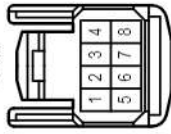

J 4
White

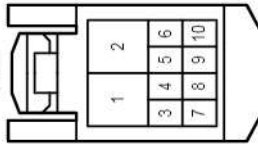

J 5
White



J 6
White

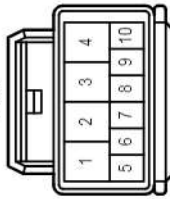

J 7
White



J 9
Black

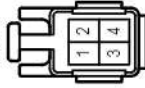

J 10
White

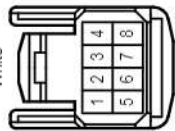

J 11
White

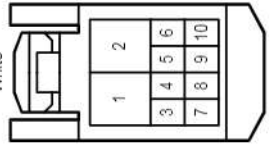

J 12
White



J 13
White

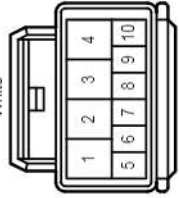

J 14
White



J 15
White



J 17
White



J 18
Black



J 19
Black



M 2
Black



O 1
Black



Position of Parts in Body <LHD Liftgate Type>

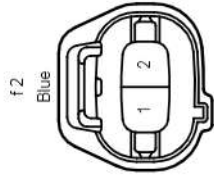
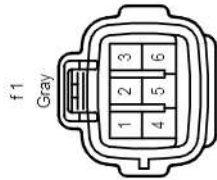
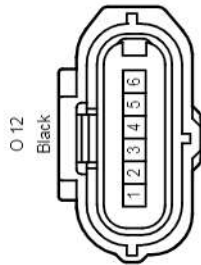
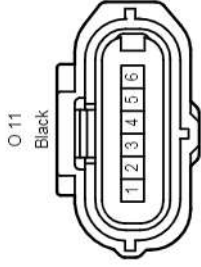
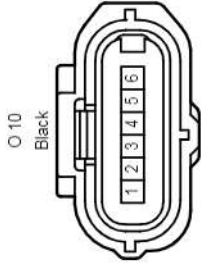
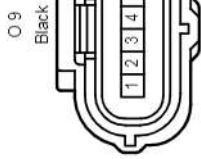
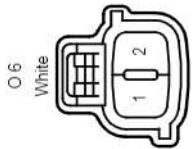

Position of Parts in Body <LHD Liftgate Type>

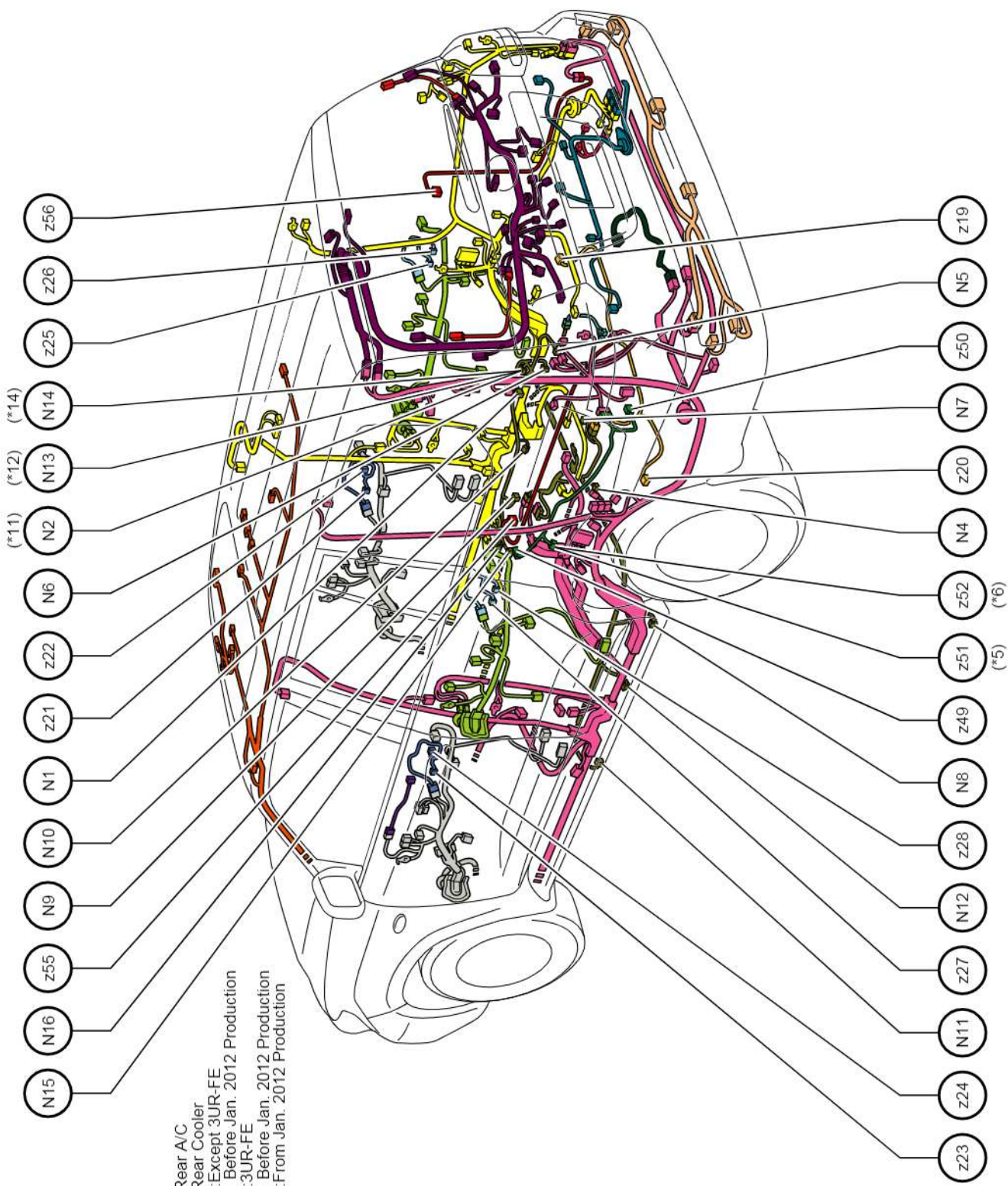

- * 5:Rear A/C
- * 6:Rear Cooler
- * 11:Except 3UR-FE
Before Jan. 2012 Production
- * 12:3UR-FE
Before Jan. 2012 Production
- * 14:From Jan. 2012 Production

Position of Parts in Body <LHD Liftgate Type>

N	1	Fuel Sender Gage Assembly (Main)
N	2	Fuel Pump Control ECU Assembly
N	4	No.1 Height Control Valve Assembly
N	5	Rear Height Control Sensor Sub-Assembly RH
N	6	Rear Shock Absorber Assembly RH
N	7	Rear Height Control Sensor Sub-Assembly LH
N	8	Rear Shock Absorber Assembly LH
N	9	Front Shock Absorber Assembly RH
N	10	Front Shock Absorber Control Valve Assembly RH
N	11	Front Shock Absorber Assembly LH
N	12	Front Shock Absorber Control Valve Assembly LH
N	13	Fuel Pump Control ECU Assembly
N	14	Fuel Pump Control ECU Assembly
N	15	DPF Temperature Sensor RH (Exhaust Gas Temperature Sensor)
N	16	Differential Pressure Sensor RH
Z	19	Rear Speed Sensor RH
Z	20	Rear Speed Sensor LH
Z	21	Front Door Outside Handle Assembly RH
Z	22	Front Door Electrical Key Oscillator RH
Z	23	Front Door Outside Handle Assembly LH
Z	24	Front Door Electrical Key Oscillator LH
Z	25	Rear Door Outside Handle Assembly RH
Z	26	Rear Door Electrical Key Oscillator RH
Z	27	Rear Door Outside Handle Assembly LH
Z	28	Rear Door Electrical Key Oscillator LH
Z	49	Rear Blower with Fan Motor Sub-Assembly
Z	50	Rear Cooling Unit Expansion Valve
Z	51	Blower Motor Control
Z	52	Rear Blower Resistor
Z	55	Rear No.1 Cooler Thermistor LH
Z	56	Rear No.1 Cooler Thermistor RH

Position of Parts in Body <LHD Liftgate Type>

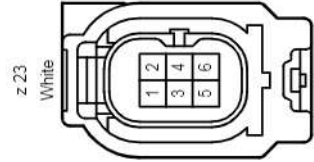
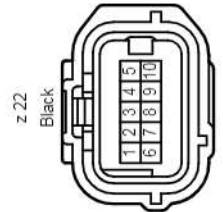
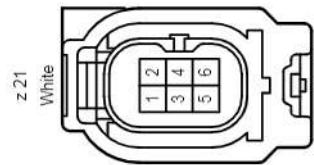
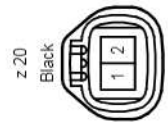
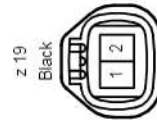
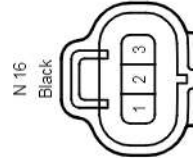
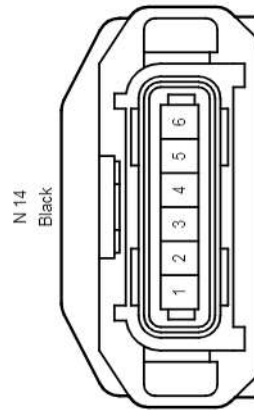
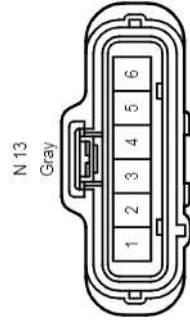
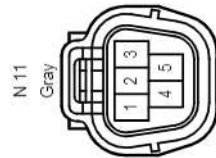
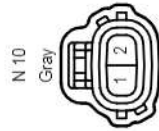
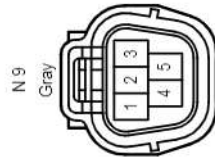
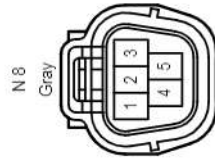
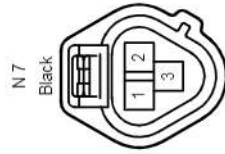
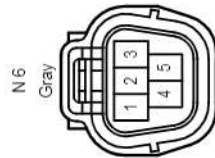
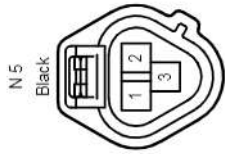
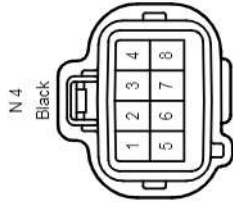
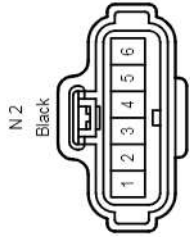
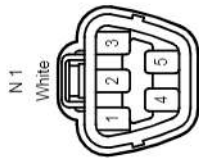

Position of Parts in Body <LHD Liftgate Type>

z 28
Black

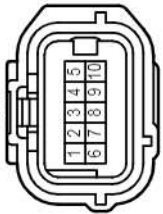

z 49
Black

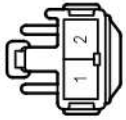

z 50
Black

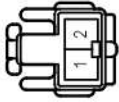

z 51
Black

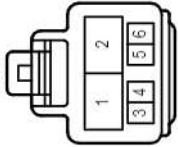

z 52
Black

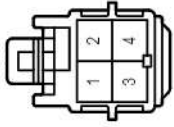

z 55
White

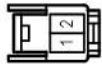

z 56
White



Position of Parts in Body <LHD Liftgate Type>

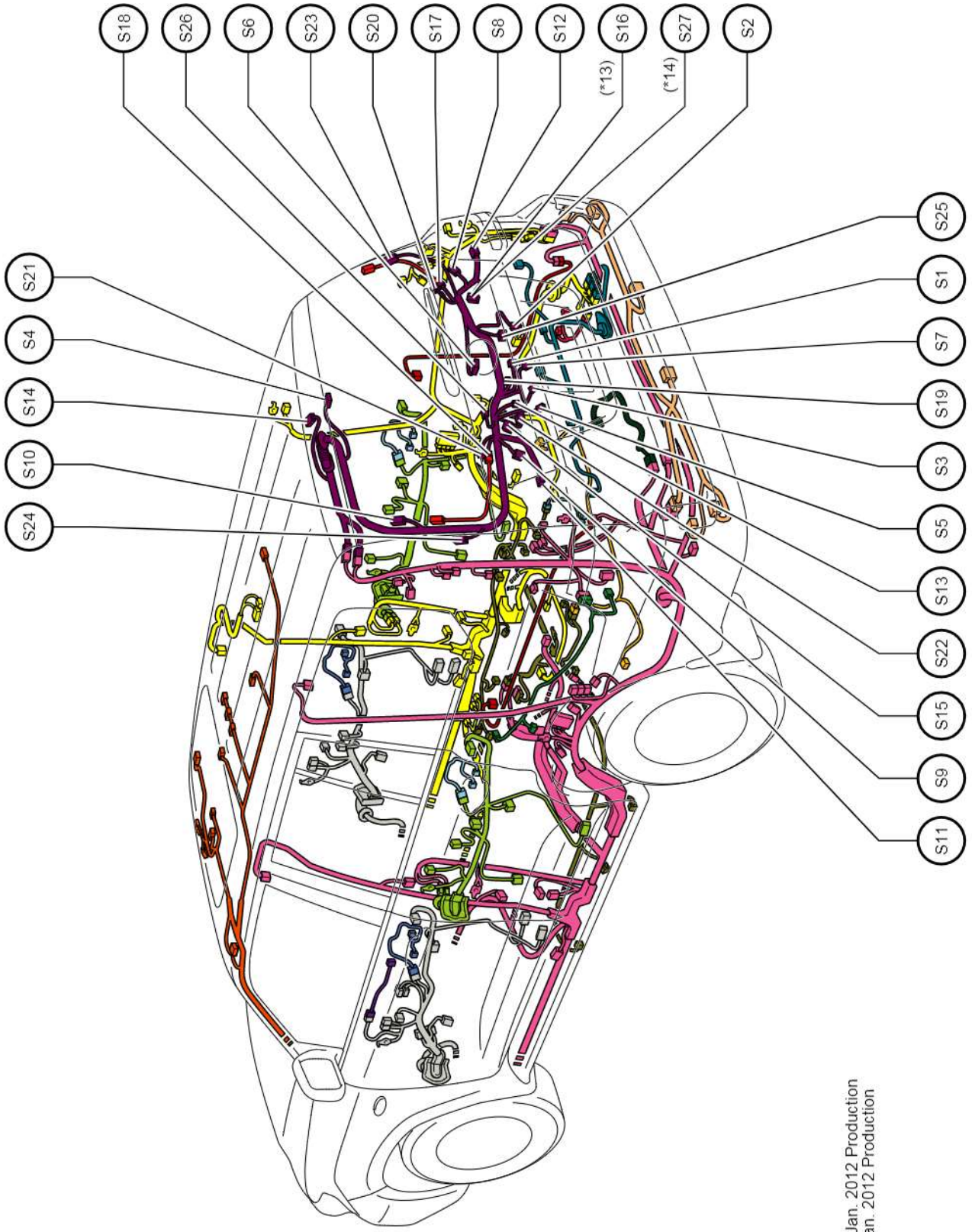

* 13: Before Jan. 2012 Production
* 14: From Jan. 2012 Production

S	1	Back Door Lock Assembly
S	2	License Plate Light Assembly RH
S	3	License Plate Light Assembly LH
S	4	Center Stop Light Assembly
S	5	Rear Television Camera Assembly
S	6	Rear Wiper Motor Assembly
S	7	Back Door Opener Switch Assembly
S	8	Rear Header Speaker Assembly RH
S	9	Rear Header Speaker Assembly LH
S	10	Glass Breakage Sensor (Back Door Glass)
S	11	Rear Light Assembly LH
S	12	Rear Light Assembly RH
S	13	Option Connector (Back Guide Monitor)
S	14	Noise Filter (Rear Window Defogger and Stop)
S	15	Junction Connector
S	16	Junction Connector
S	17	Rear Window Defogger (Back Door Glass)
S	18	Rear Window Defogger (Back Door Glass)
S	19	Power Back Door Main Switch
S	20	Rear Window Defogger (Back Door Glass)
S	21	Rear Window Defogger (Back Door Glass)
S	22	Back Door Lock Assembly
S	23	Power Back Door Sensor Assembly RH
S	24	Power Back Door Sensor Assembly LH
S	25	Door Control Switch
S	26	Diode (Power Back Door)
S	27	Junction Connector

Position of Parts in Body <LHD Liftgate Type>

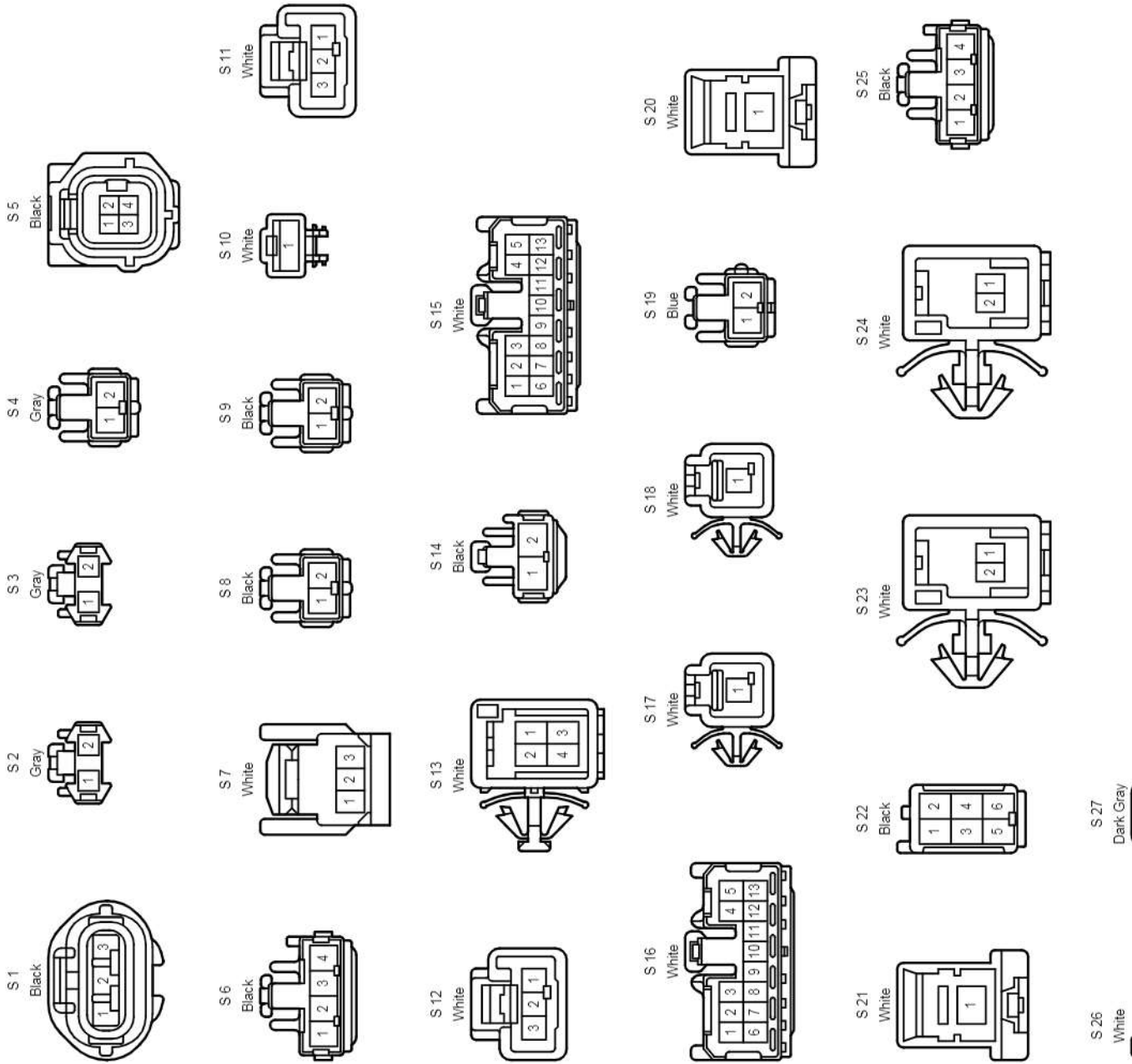

Wire and Wire in Body <LHD Liftgate Type>

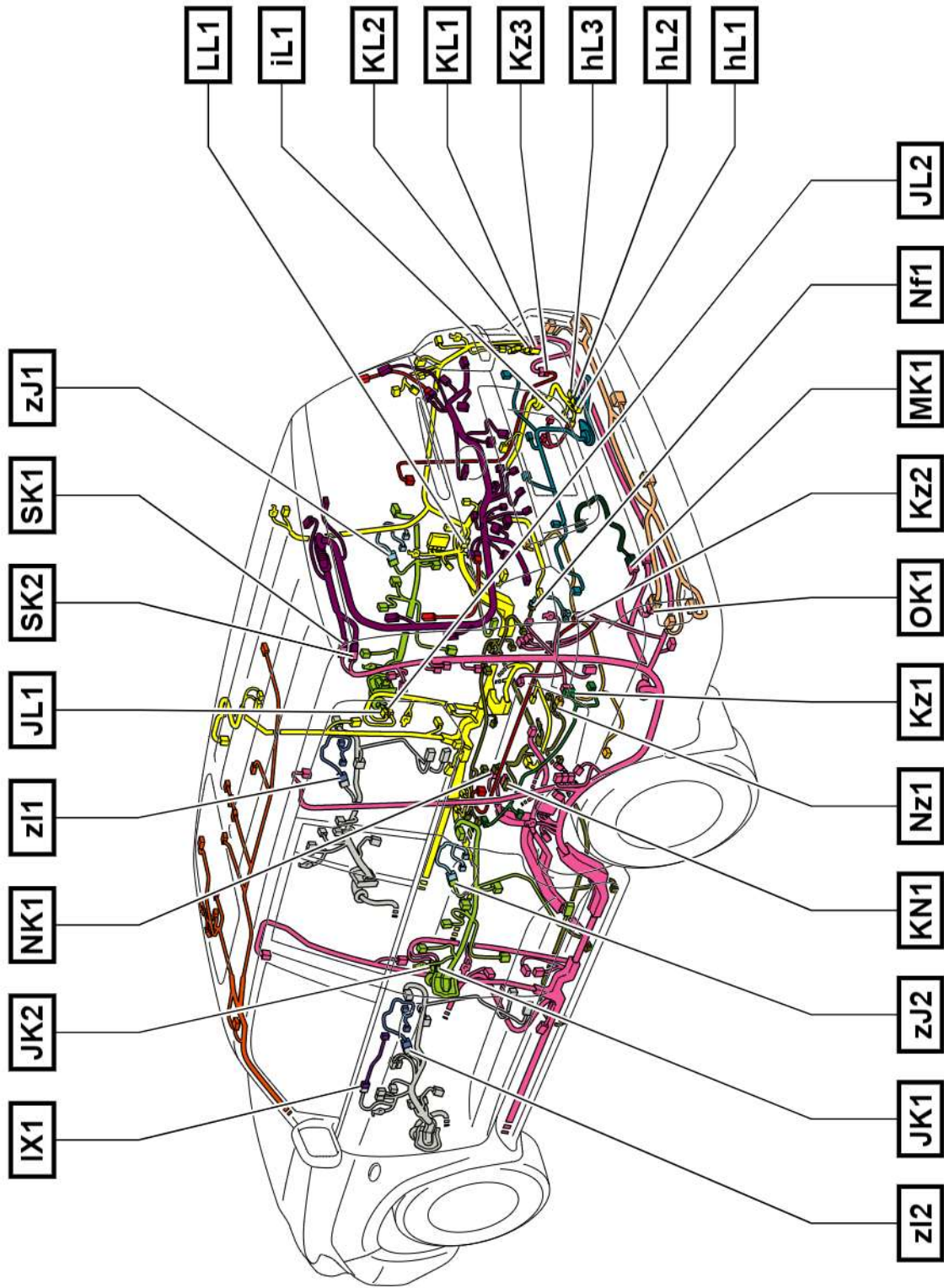

Wire and Wire in Body <LHD Liftgate Type>

IX1
White

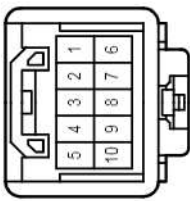
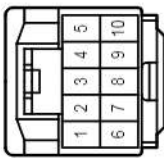

JK1
White

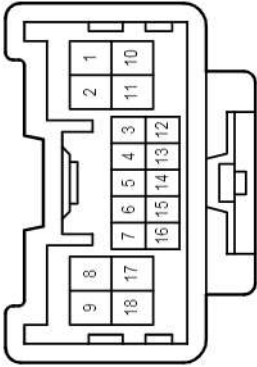
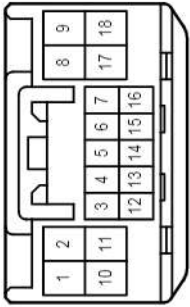

JK2
White

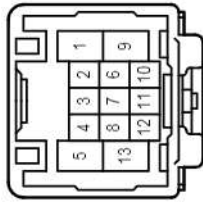
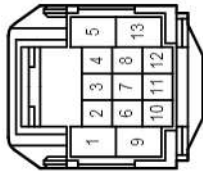

JL1
White

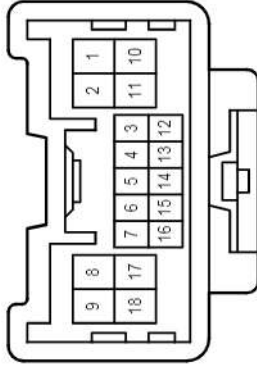
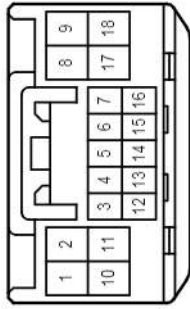

JL2
White

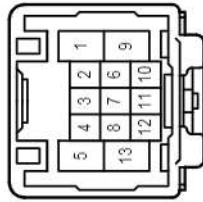
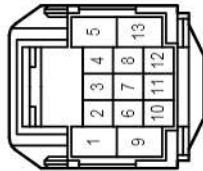

KL1
White

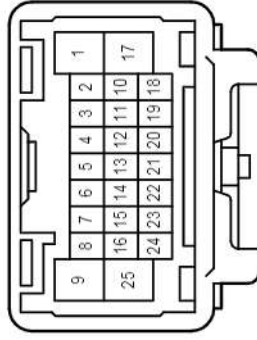
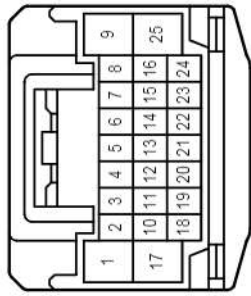

KL2
White

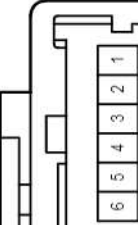
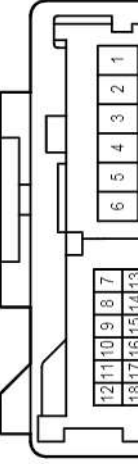
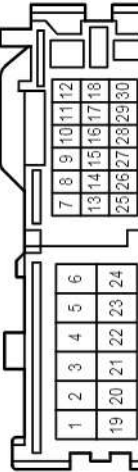

Wire and Wire in Body <LHD Liftgate Type>

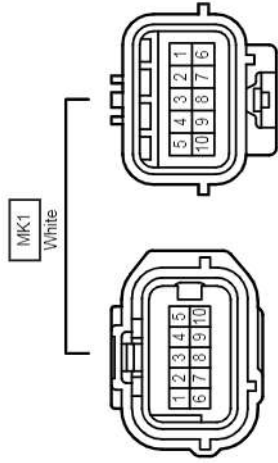
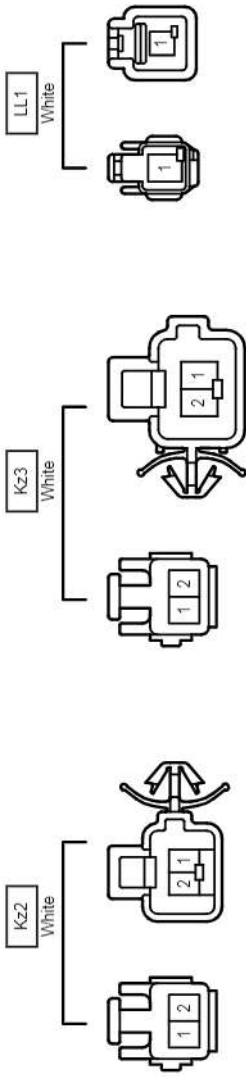

NK1 White

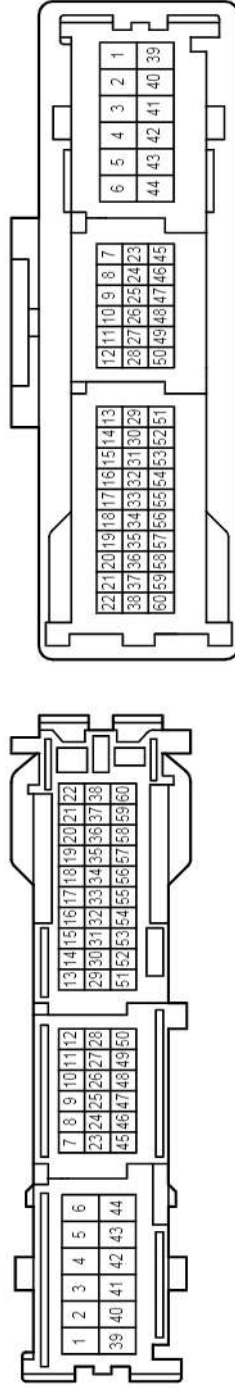

NF1 White

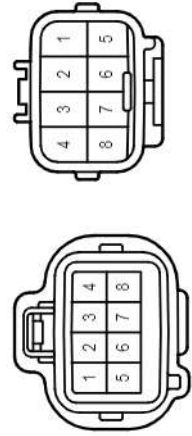

Nz1 Gray

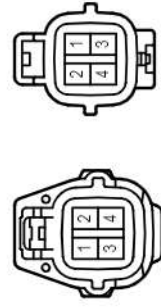

OK1 Black



SK1 White



Wire and Wire in Body <LHD Liftgate Type>

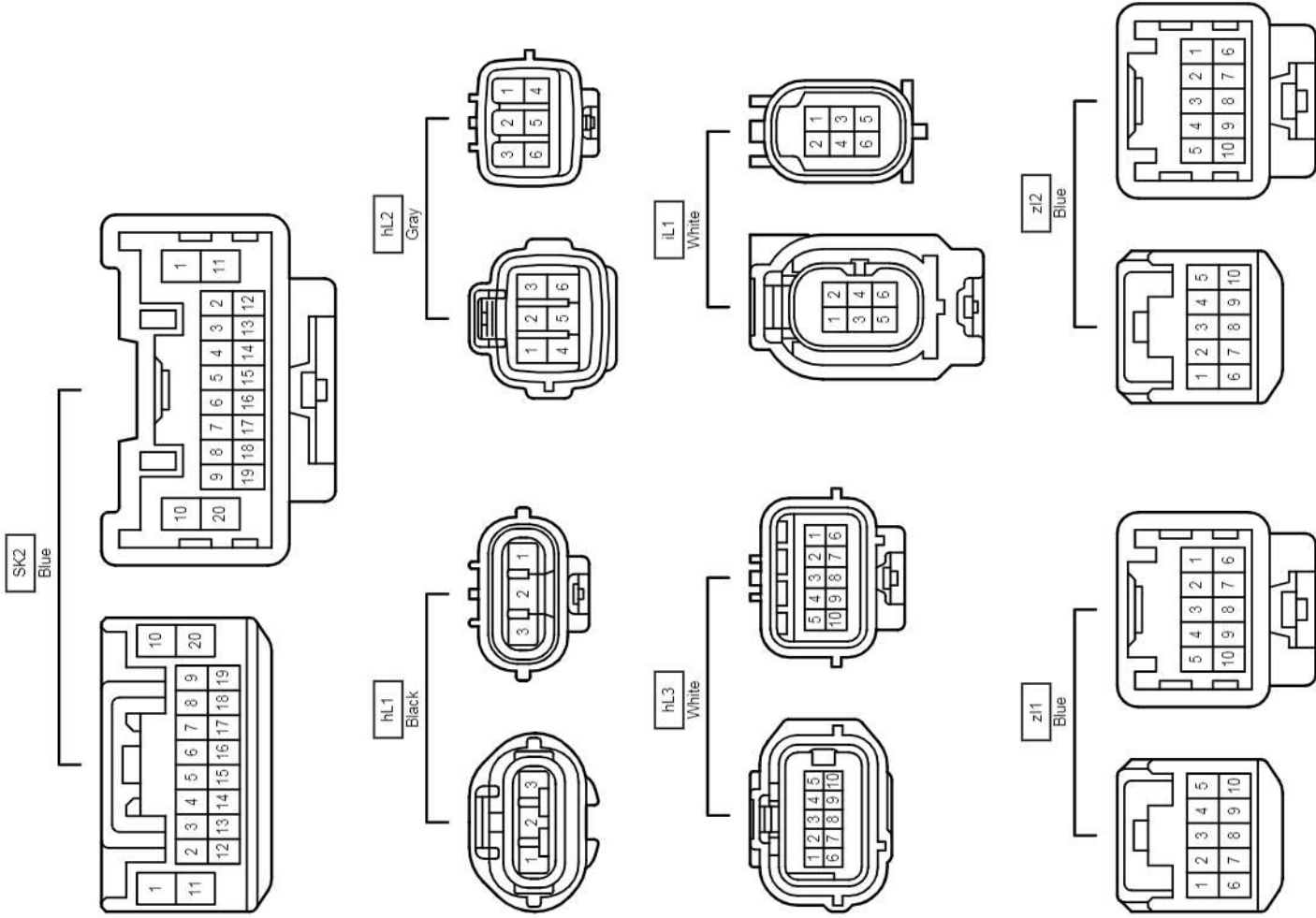

Ground Points in Body <RHD Liftgate Type>

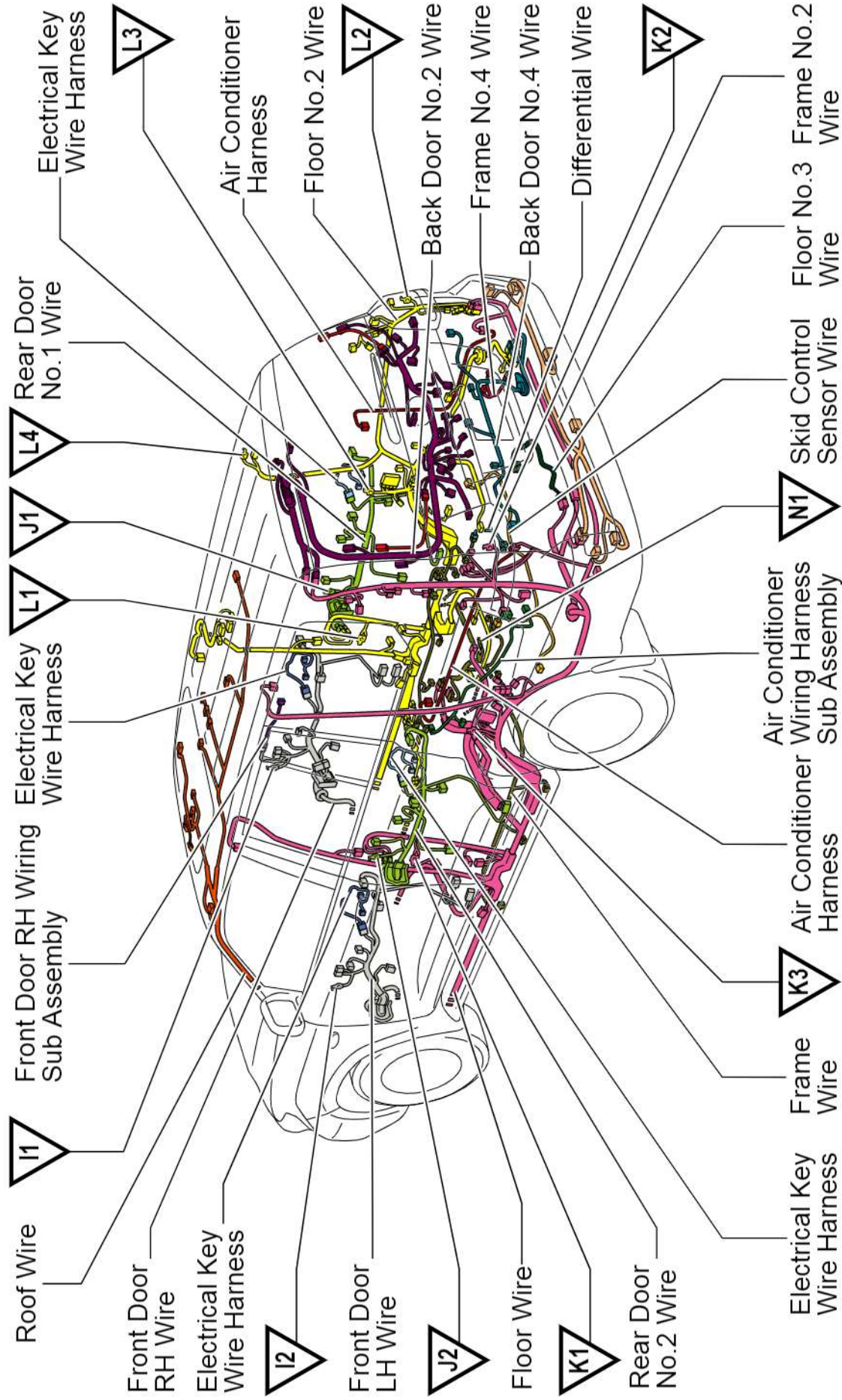

Position of Parts in Body <RHD Liftgate Type>

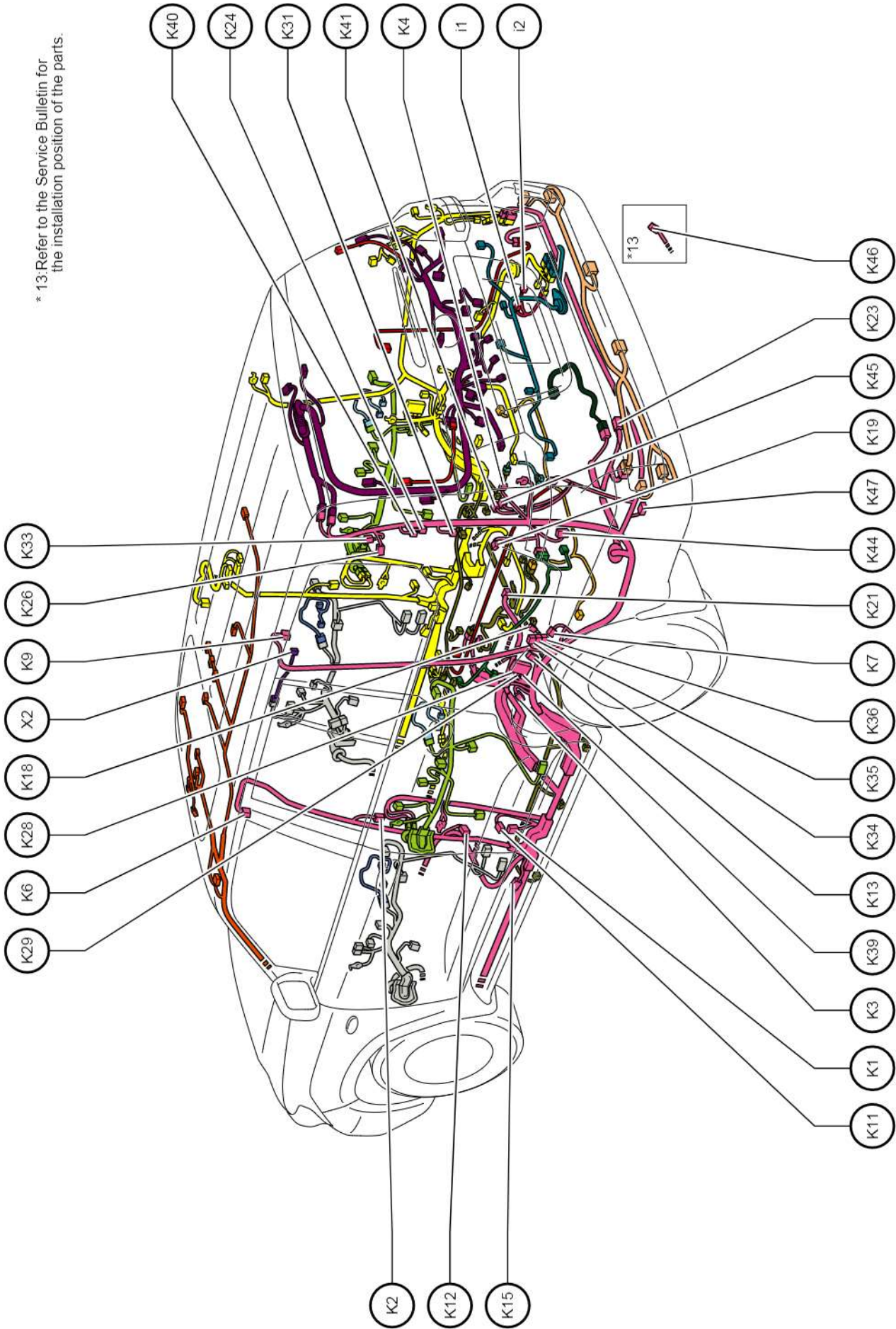

* 13: Refer to the Service Bulletin for the installation position of the parts.

Position of Parts in Body <RHD Liftgate Type>

- K 1 Front Pretensioner LH
- K 2 Front Door Courtesy Light Switch Assembly LH
- K 3 Rear Door Courtesy Light Switch Assembly LH
- K 4 Rear Combination Light Assembly LH
- K 6 Curtain Shield Airbag Assembly Circuit LH
- K 7 Rear Side Airbag Sensor Assembly LH
- K 9 Curtain Shield Airbag Assembly Circuit LH
- K 11 Front Pre-Crash Seat Belt Motor LH
- K 12 Front Tension Reducer LH
- K 13 Rear Pretensioner LH
- K 15 No.2 Interior Illumination Light Assembly
- K 18 Theft Warning Siren Assembly
- K 19 Rear A/C Blower Assembly
- K 21 Cooler Thermistor LH
- K 23 Outside Luggage Electrical Key Antenna
- K 24 Towing Converter
- K 26 Glass Breakage Sensor (Quarter Glass LH)
- K 28 Junction Connector
- K 29 Junction Connector
- K 31 Diode (Rear Cooler)
- K 33 Diode (Stop Light)
- K 34 Suspension Control ECU
- K 35 Suspension Control ECU
- K 36 Suspension Control ECU
- K 39 Junction Connector
- K 40 Towing Converter
- K 41 Rear Power Outlet Socket Assembly
- K 44 Voltage Inverter Assembly
- K 45 Power Outlet Socket Assembly
- K 46 Theft Warning Siren Assembly
- K 47 Power Back Door Warning Buzzer

X 2 Seat Memory Switch RH

i 1 Fuel Temperature Sensor

i 2 Pressure Accumulator Sensor

Position of Parts in Body <RHD Liftgate Type>

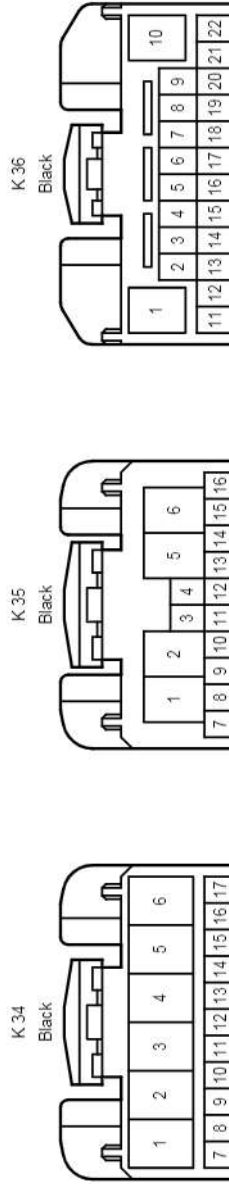
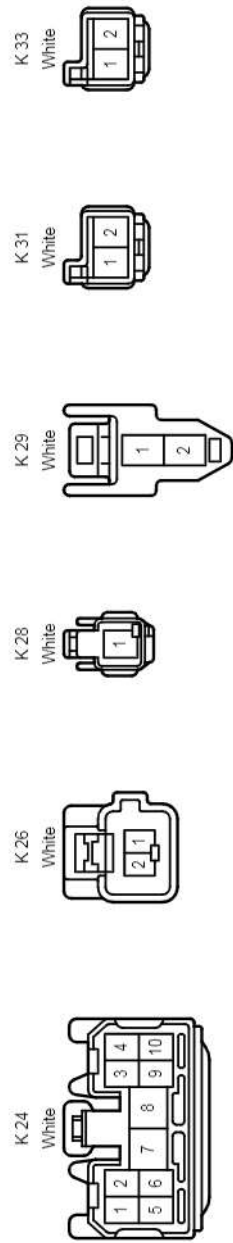
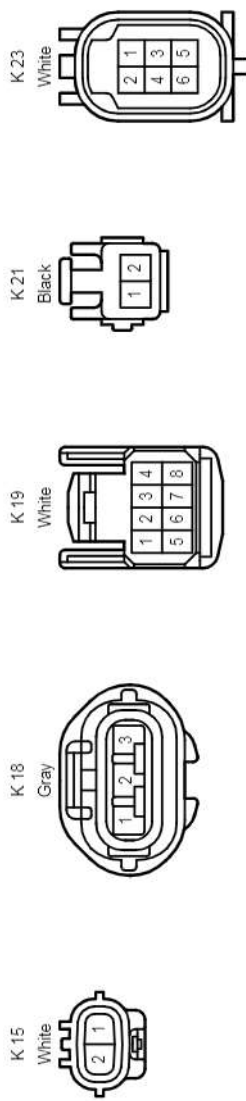
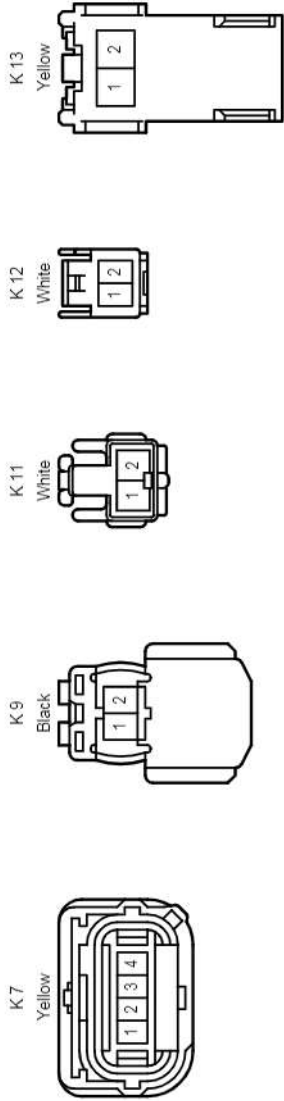
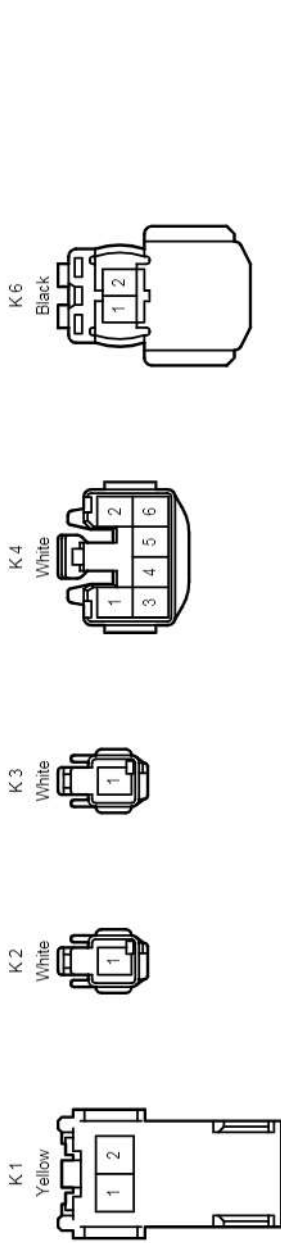

Position of Parts in Body <RHD Liftgate Type>

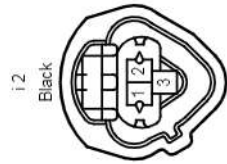
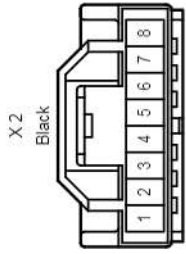
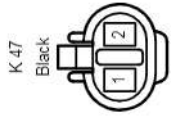
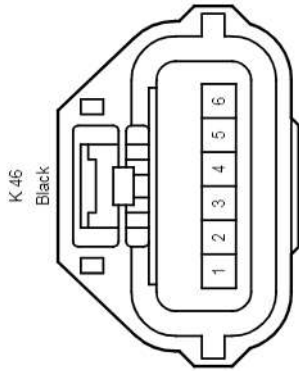

Position of Parts in Body <RHD Liftgate Type>

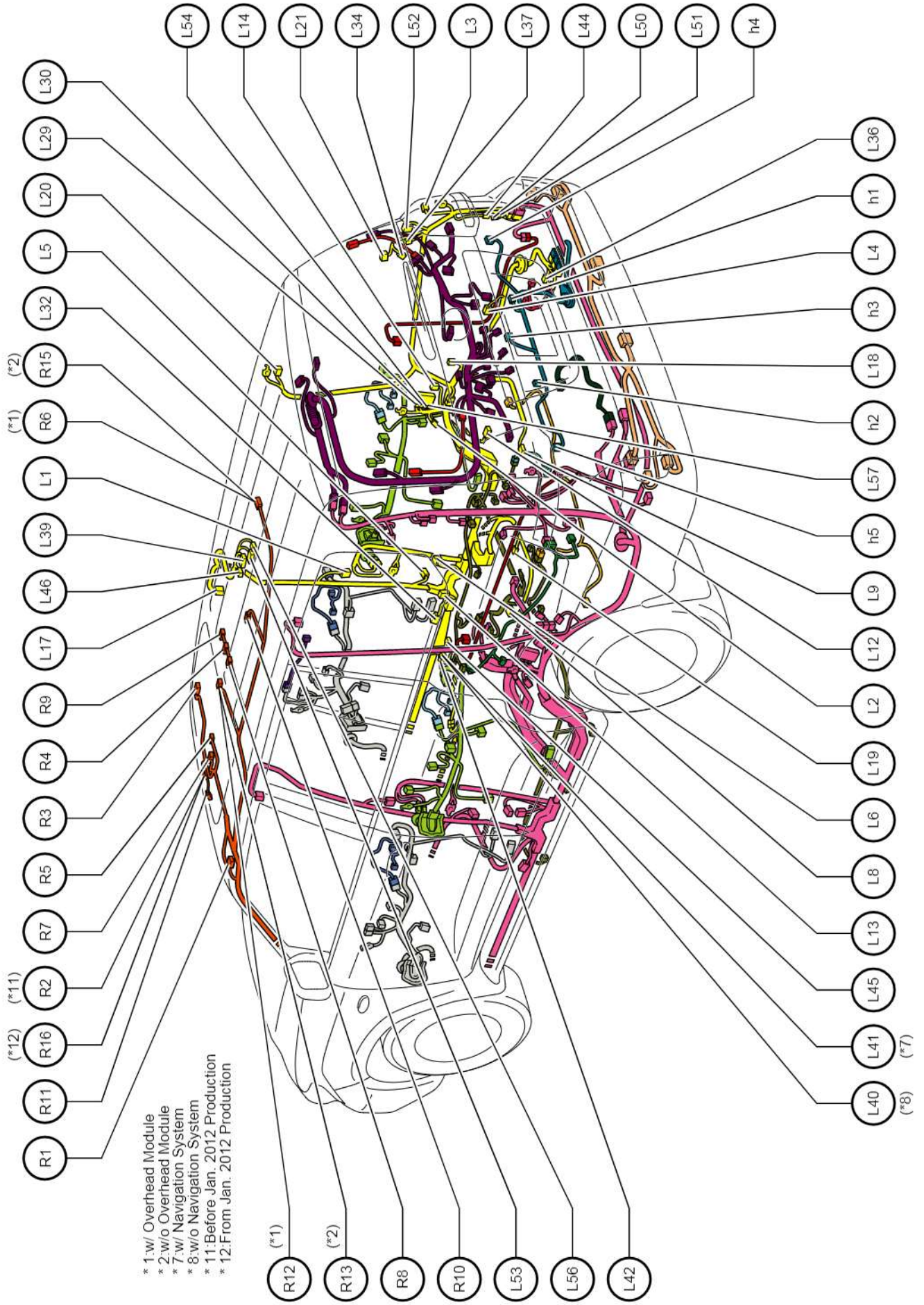

Position of Parts in Body <RHD Liftgate Type>

L	1	Front Door Courtesy Light Switch Assembly RH
L	2	Rear Door Courtesy Light Switch Assembly RH
L	3	Rear Combination Light Assembly RH
L	4	No.1 with Box Speaker Assembly
L	5	Front Pre-Crash Seat Belt Motor RH
L	6	Front Tension Reducer RH
L	8	Rear Indoor Electrical Key Oscillator
L	9	Indoor Luggage Compartment Electrical Key Oscillator
L	12	Cooler Thermistor RH
L	13	Front Pretensioner RH
L	14	Rear Pretensioner RH
L	17	Curtain Shield Airbag Assembly Circuit RH
L	18	Rear Side Airbag Sensor Assembly RH
L	19	Rear Floor Side Airbag Sensor
L	20	Curtain Shield Airbag Assembly Circuit RH
L	21	Door Control Receiver
L	29	Junction Connector
L	30	Junction Connector
L	32	No.1 Interior Illumination Light Assembly RH
L	34	Glass Breakage Sensor (Quarter Glass RH)
L	36	Height Control Pump and Motor Assembly
L	37	Option Connector (Theft Warning Radar Sensor)
L	39	Television Display Assembly
L	40	Multi-Media Interface ECU Assembly
L	41	Multi-Media Interface ECU Assembly
L	42	Multi-Media Interface ECU Assembly
L	44	Option Connector (Parking Assist-Sensor)
L	45	Multi-Media Interface ECU Assembly
L	46	Television Display Assembly
L	50	No.2 Multiplex Network Body ECU
L	51	No.2 Multiplex Network Body ECU
L	52	Power Back Door Unit Assembly
L	53	Television Display Assembly
L	54	Junction Connector
L	56	Television Display Assembly
L	57	Junction Connector
R	1	Visor Assembly LH
R	2	Inner Rear View Mirror Assembly
R	3	Visor Assembly RH
R	4	No.2 Room Light Assembly
R	5	Sliding Roof Control ECU
R	6	No.3 Room Light Assembly
R	7	Overhead Module

Position of Parts in Body <RHD Liftgate Type>

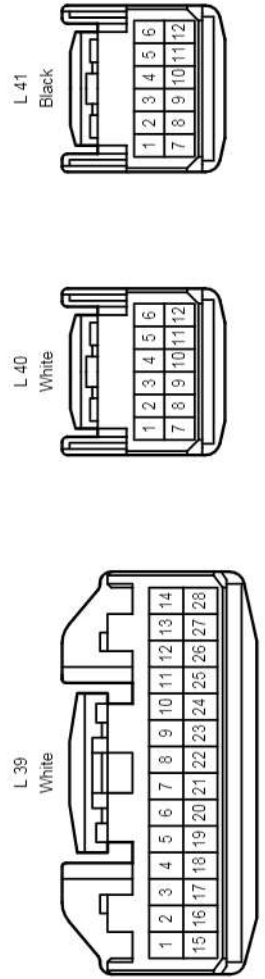
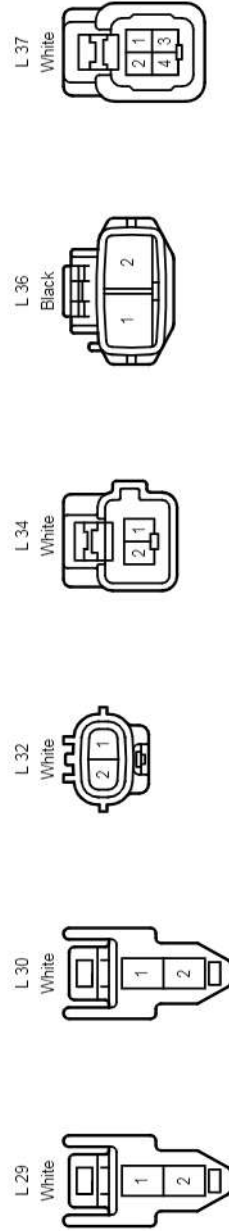
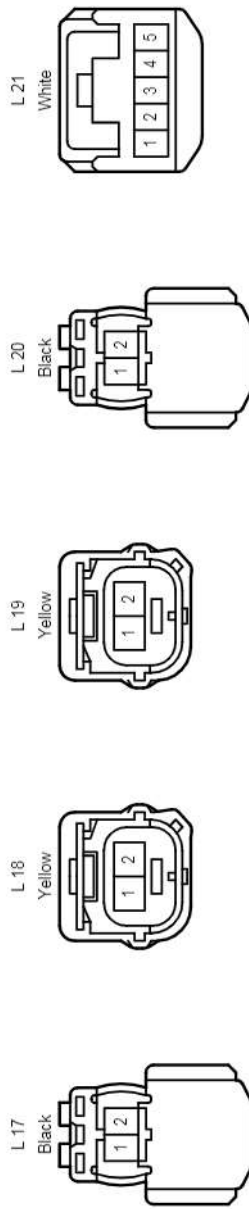
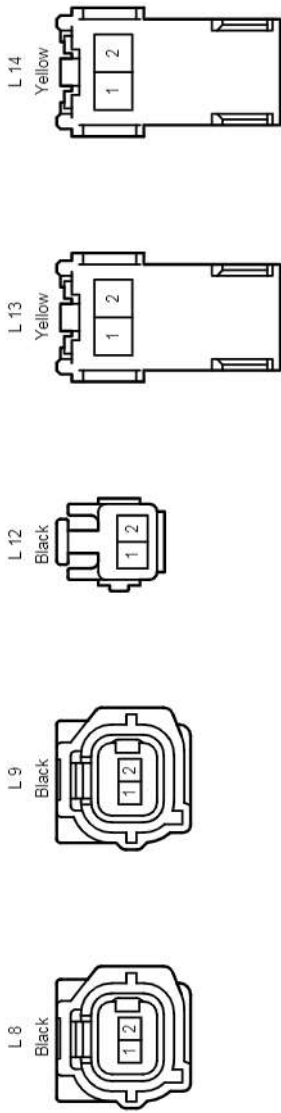

Position of Parts in Body <RHD Liftgate Type>

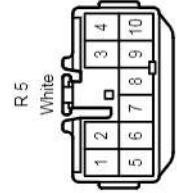
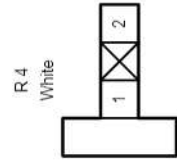
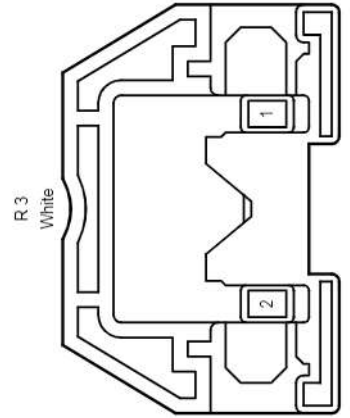
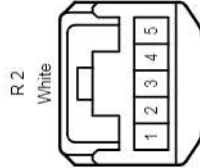
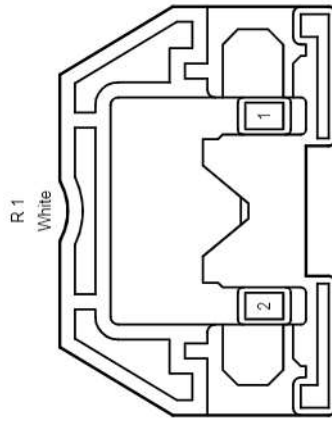
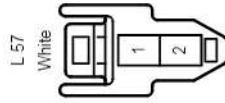
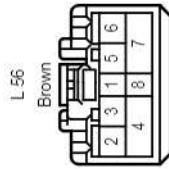
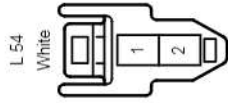
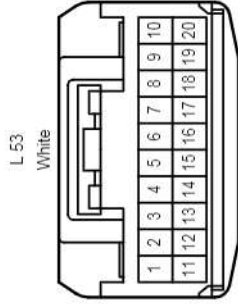
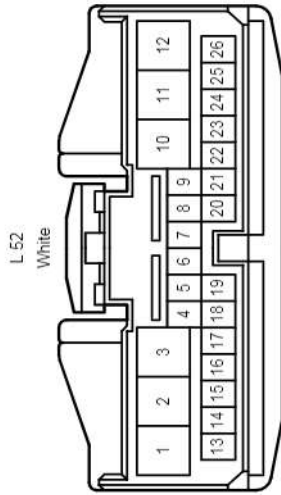
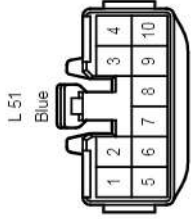
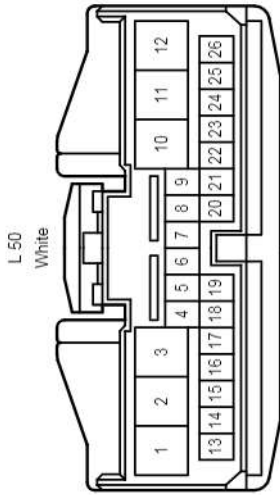

cardiagn.com

Position of Parts in Body <RHD Liftgate Type>

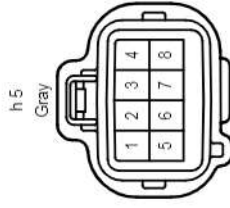
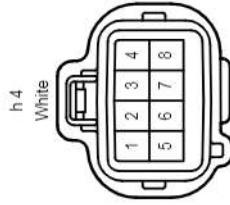
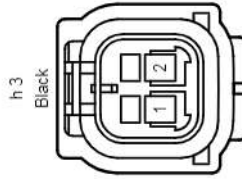
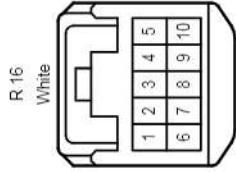
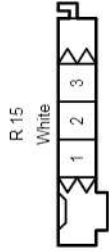
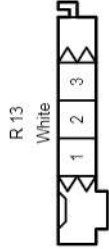
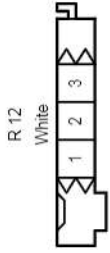
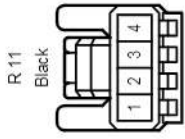
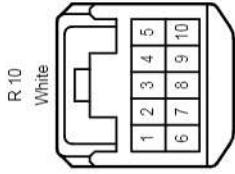
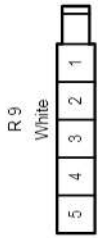

Position of Parts in Body <RHD Liftgate Type>

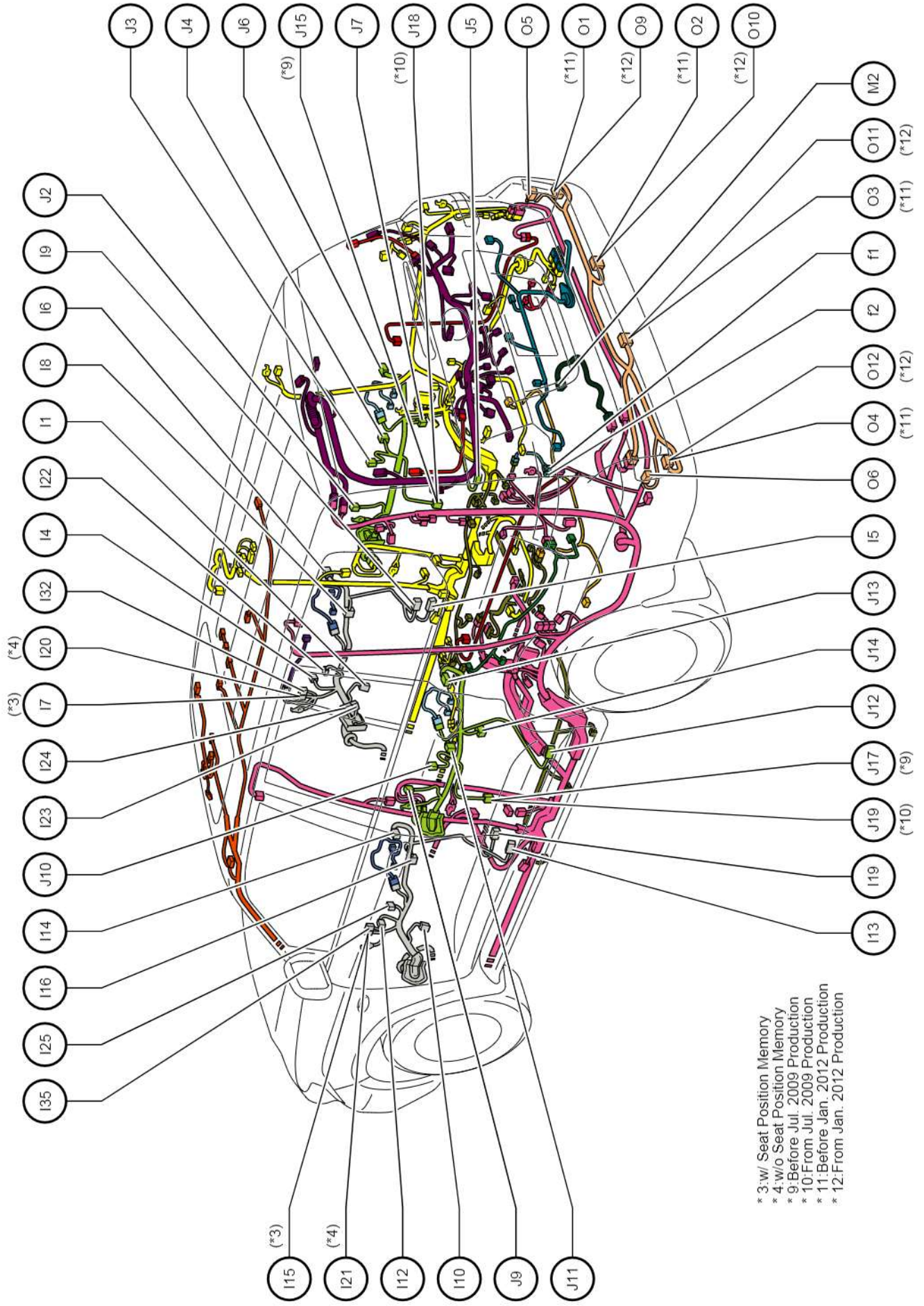

- * 3:w/ Seat Position Memory
- * 4:w/o Seat Position Memory
- * 9:Before Jul. 2009 Production
- * 10:From Jul. 2009 Production
- * 11:Before Jan. 2012 Production
- * 12:From Jan. 2012 Production

Position of Parts in Body <RHD Liftgate Type>

I	1	Front No.1 Speaker Assembly RH
I	4	Front Power Window Regulator Motor Assembly RH
I	5	Front Door Courtesy Light Assembly RH
I	6	Front Door Lock Assembly RH
I	7	Outer Rear View Mirror Assembly RH
I	8	Diode (Front Door Courtesy Switch RH)
I	9	Front Side Airbag Sensor Assembly RH
I	10	Front No.1 Speaker Assembly LH
I	12	Front Power Window Regulator Motor Assembly LH
I	13	Front Door Courtesy Light Assembly LH
I	14	Front Door Lock Assembly LH
I	15	Outer Rear View Mirror Assembly LH
I	16	Diode (Front Door Courtesy Switch LH)
I	19	Front Side Airbag Sensor Assembly LH
I	20	Outer Rear View Mirror Assembly RH
I	21	Outer Rear View Mirror Assembly LH
I	22	Multiplex Network Master Switch Assembly
I	23	Outer Mirror Control ECU Assembly
I	24	Outer Mirror Control ECU Assembly
I	25	Front Power Window Regulator Switch Assembly LH
I	32	Outer Rear View Mirror Assembly RH
I	35	Outer Rear View Mirror Assembly LH
J	2	Rear No.3 Speaker Assembly RH
J	3	Rear Power Window Regulator Switch Assembly RH
J	4	Rear Power Window Regulator Motor Assembly RH
J	5	Rear Door Courtesy Light Assembly RH
J	6	Rear Door Lock Assembly RH
J	7	Diode (Rear Door Courtesy Switch RH)
J	9	Rear No.3 Speaker Assembly LH
J	10	Rear Power Window Regulator Switch Assembly LH
J	11	Rear Power Window Regulator Motor Assembly LH
J	12	Rear Door Courtesy Light Assembly LH
J	13	Rear Door Lock Assembly LH
J	14	Diode (Rear Door Courtesy Switch LH)
J	15	Rear Speaker Set RH
J	17	Rear Speaker Set LH
J	18	Rear Speaker Set RH
J	19	Rear Speaker Set LH
M	2	Fuel Sender Gage Assembly (Sub)
O	1	No.2 Ultrasonic Sensor RH
O	2	No.3 Ultrasonic Sensor RH

Position of Parts in Body <RHD Liftgate Type>

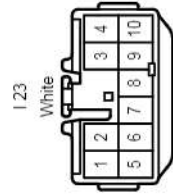
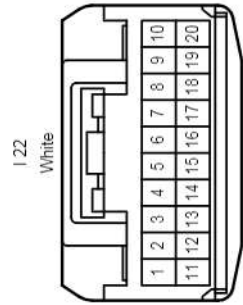
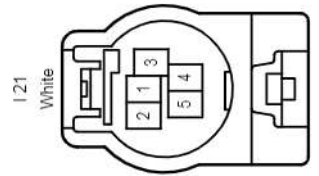
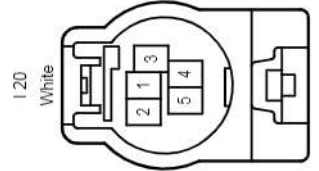
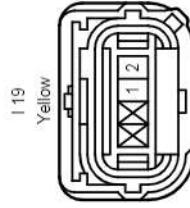
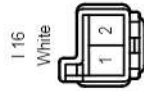
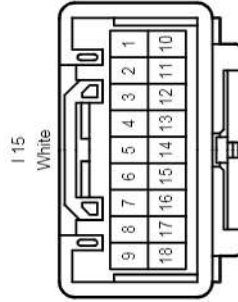
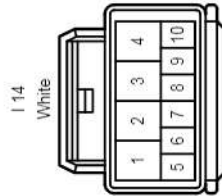
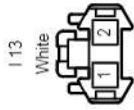
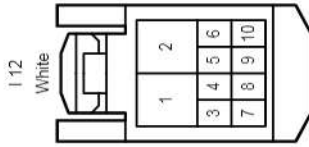
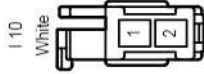
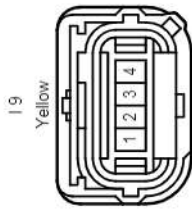
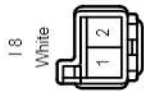
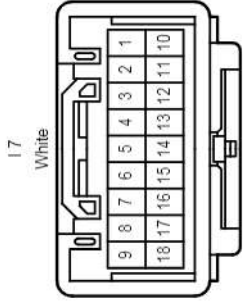
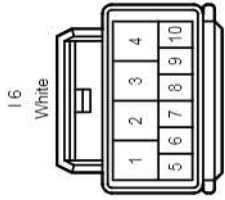
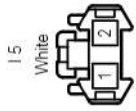
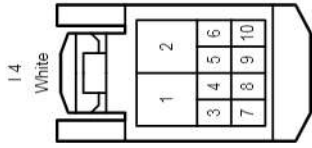
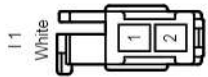

Position of Parts in Body <RHD Liftgate Type>

I 32
White

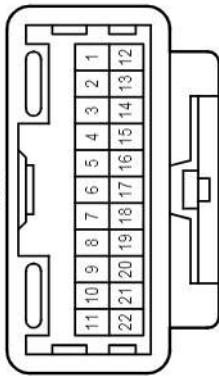

I 35
White

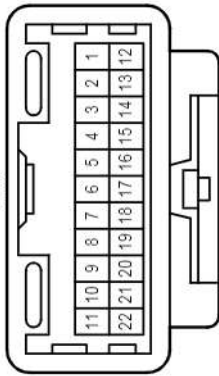

J 2
Black

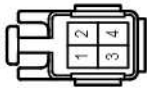

J 3
White

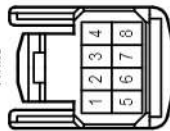

J 4
White

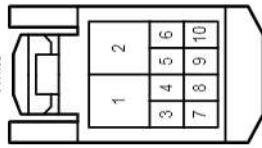

J 5
White



J 6
White

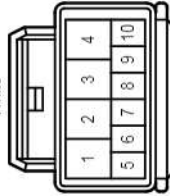

J 7
White



J 9
Black

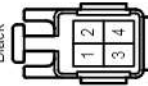

J 10
White

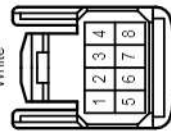

J 11
White

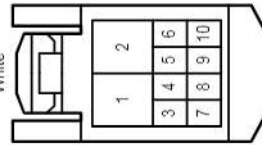

J 12
White



J 13
White

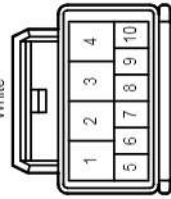

J 14
White



J 15
White

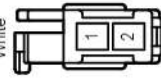

J 17
White

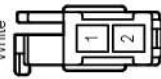

J 18
Black

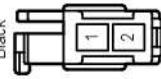

J 19
Black

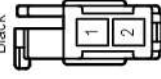

M 2
Black

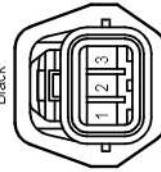

O 1
Black

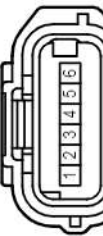

O 2
Black

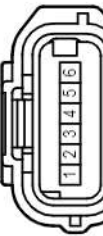

O 3
Black

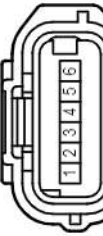

O 4
Black

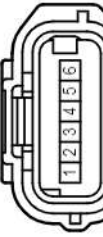

Position of Parts in Body <RHD Liftgate Type>

O 11
Black

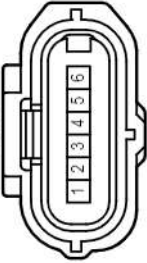

O 12
Black

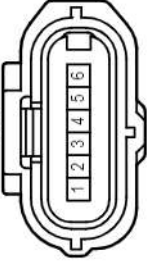

f 1
Gray

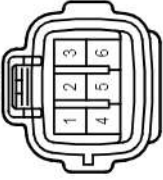

f 2
Blue



Position of Parts in Body <RHD Liftgate Type>

N	1	Fuel Sender Gage Assembly (Main)
N	2	Fuel Pump Control ECU Assembly
N	4	No.1 Height Control Valve Assembly
N	5	Rear Height Control Sensor Sub-Assembly RH
N	6	Rear Shock Absorber Assembly RH
N	7	Rear Height Control Sensor Sub-Assembly LH
N	8	Rear Shock Absorber Assembly LH
N	9	Front Shock Absorber Assembly RH
N	10	Front Shock Absorber Control Valve Assembly RH
N	11	Front Shock Absorber Assembly LH
N	12	Front Shock Absorber Control Valve Assembly LH
N	14	Fuel Pump Control ECU Assembly
N	15	DPF Temperature Sensor RH (Exhaust Gas Temperature Sensor)
N	16	Differential Pressure Sensor RH
z	19	Rear Speed Sensor RH
z	20	Rear Speed Sensor LH
z	21	Front Door Outside Handle Assembly RH
z	22	Front Door Electrical Key Oscillator RH
z	23	Front Door Outside Handle Assembly LH
z	24	Front Door Electrical Key Oscillator LH
z	25	Rear Door Outside Handle Assembly RH
z	26	Rear Door Electrical Key Oscillator RH
z	27	Rear Door Outside Handle Assembly LH
z	28	Rear Door Electrical Key Oscillator LH
z	49	Rear Blower with Fan Motor Sub-Assembly
z	50	Rear Cooling Unit Expansion Valve
z	51	Blower Motor Control
z	52	Rear Blower Resistor
z	55	Rear No.1 Cooler Thermistor LH
z	56	Rear No.1 Cooler Thermistor RH

Position of Parts in Body <RHD Liftgate Type>

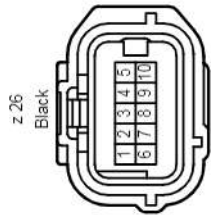
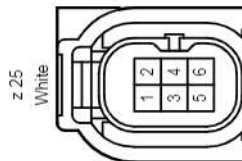
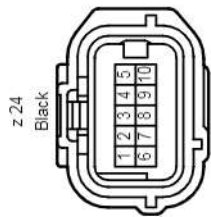
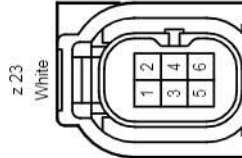
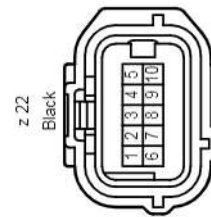
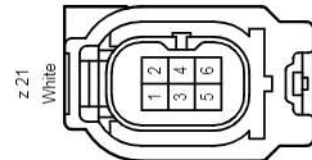
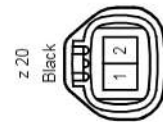
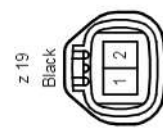
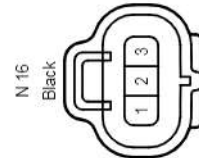
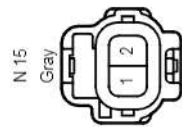
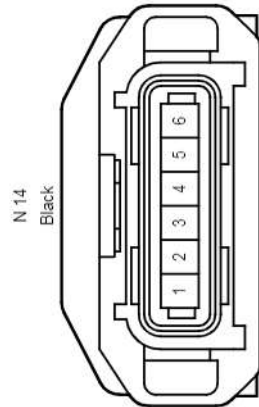
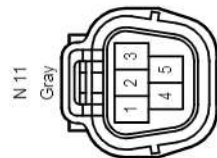
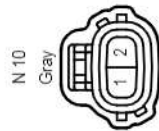
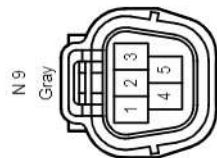
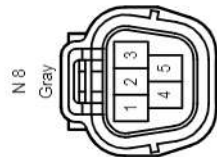
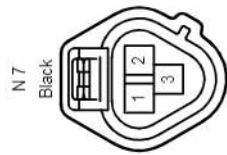
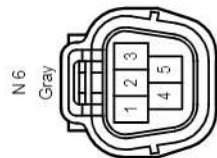
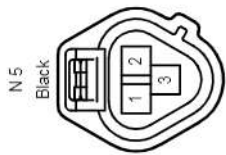
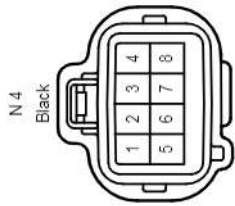
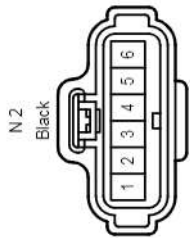
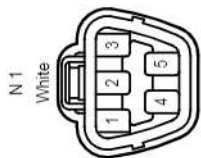

Position of Parts in Body <RHD Liftgate Type>

z 52
Black

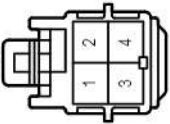

z 55
White



z 56
White



Position of Parts in Body <RHD Liftgate Type>

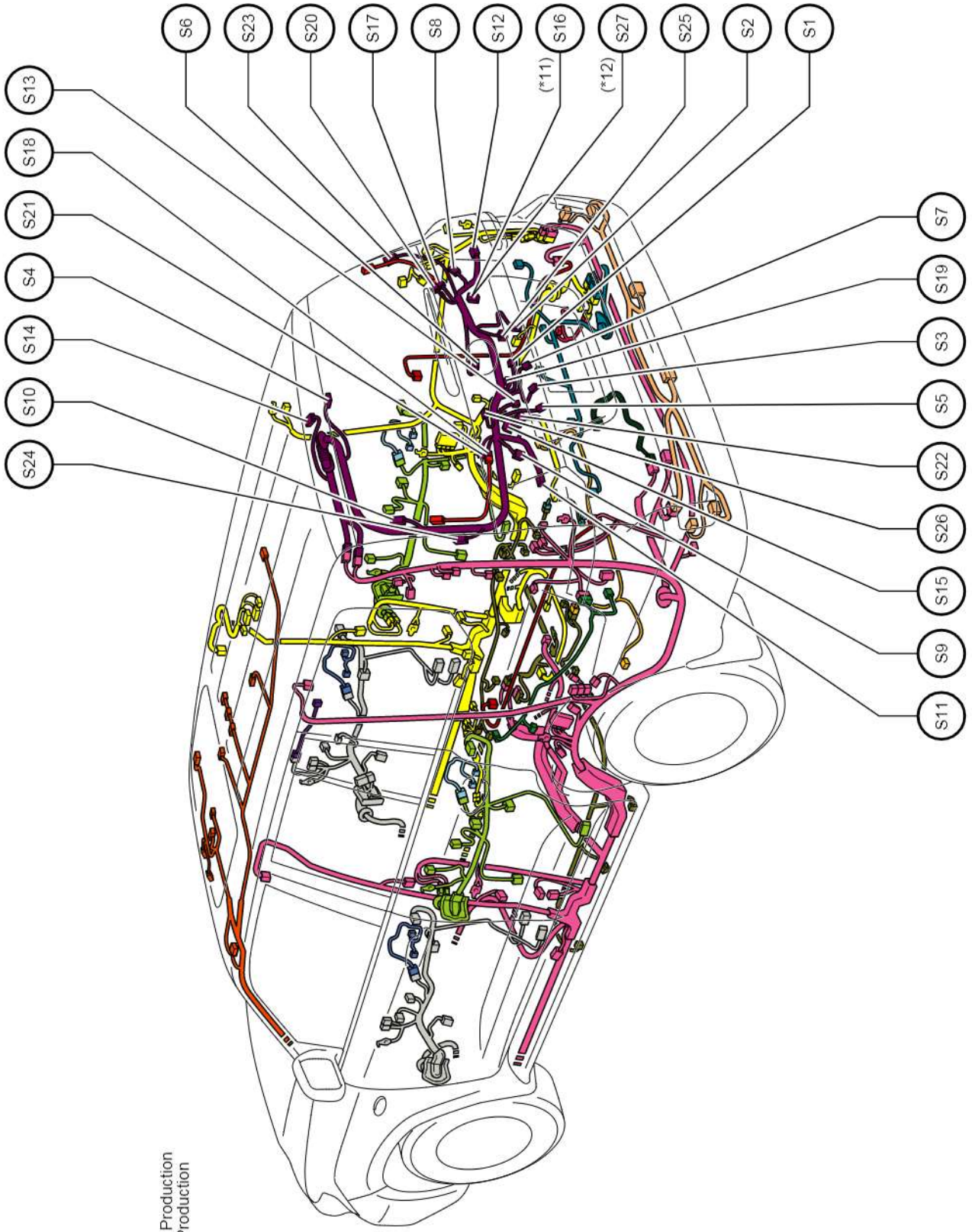

* 11: Before Jan. 2012 Production
 * 12: From Jan. 2012 Production

Position of Parts in Body <RHD Liftgate Type>

- S 1 Back Door Lock Assembly
- S 2 License Plate Light Assembly RH
- S 3 License Plate Light Assembly LH
- S 4 Center Stop Light Assembly
- S 5 Rear Television Camera Assembly
- S 6 Rear Wiper Motor Assembly
- S 7 Back Door Opener Switch Assembly
- S 8 Rear Header Speaker Assembly RH
- S 9 Rear Header Speaker Assembly LH
- S 10 Glass Breakage Sensor (Back Door Glass)
- S 11 Rear Light Assembly LH
- S 12 Rear Light Assembly RH
- S 13 Option Connector (Back Guide Monitor)
- S 14 Noise Filter (Rear Window Defogger and Stop)
- S 15 Junction Connector
- S 16 Junction Connector
- S 17 Rear Window Defogger (Back Door Glass)
- S 18 Rear Window Defogger (Back Door Glass)
- S 19 Power Back Door Main Switch
- S 20 Rear Window Defogger (Back Door Glass)
- S 21 Rear Window Defogger (Back Door Glass)
- S 22 Back Door Lock Assembly
- S 23 Power Back Door Sensor Assembly RH
- S 24 Power Back Door Sensor Assembly LH
- S 25 Door Control Switch
- S 26 Diode (Power Back Door)
- S 27 Junction Connector

Position of Parts in Body <RHD Liftgate Type>

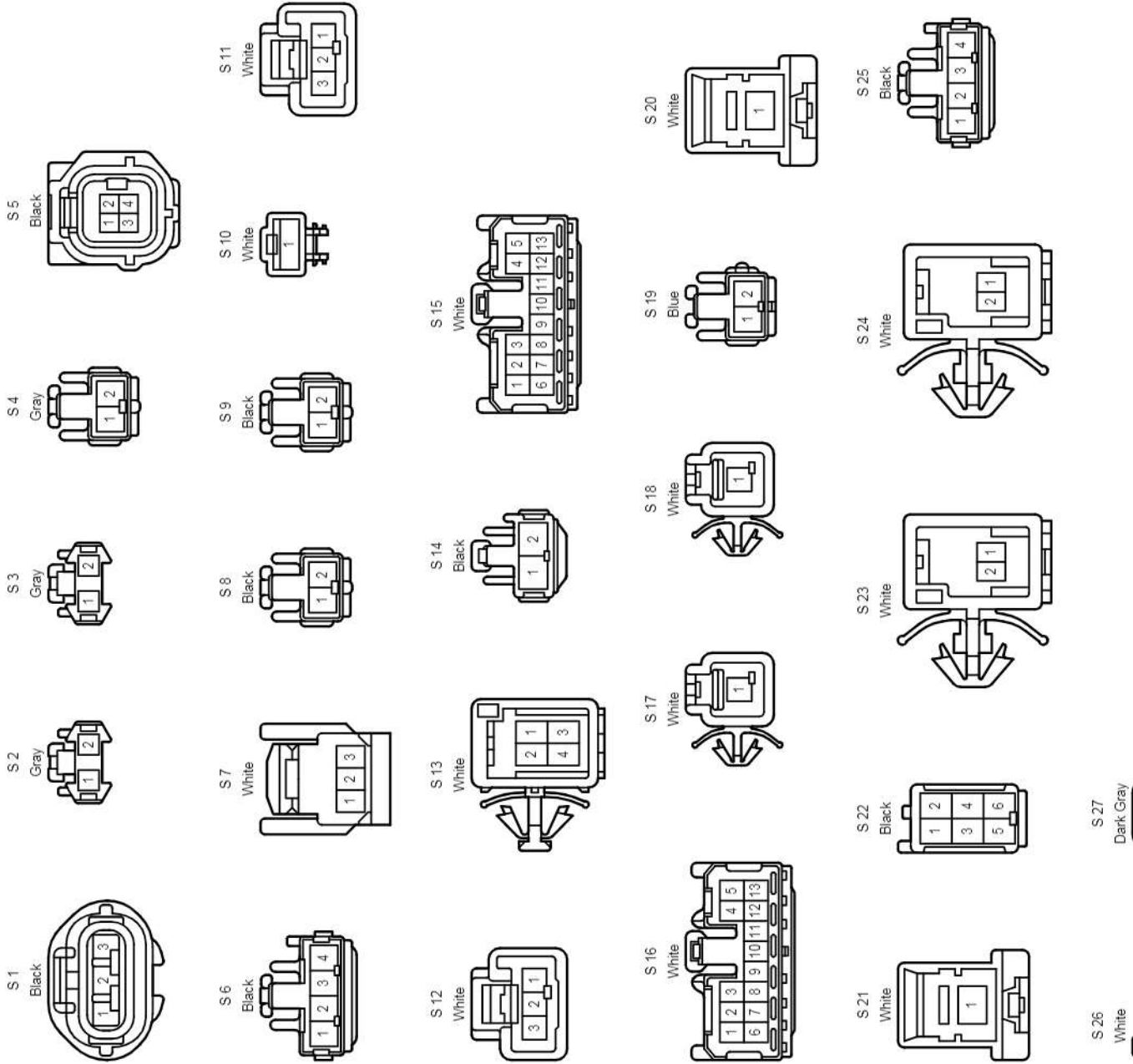

Wire and Wire in Body <RHD Liftgate Type>

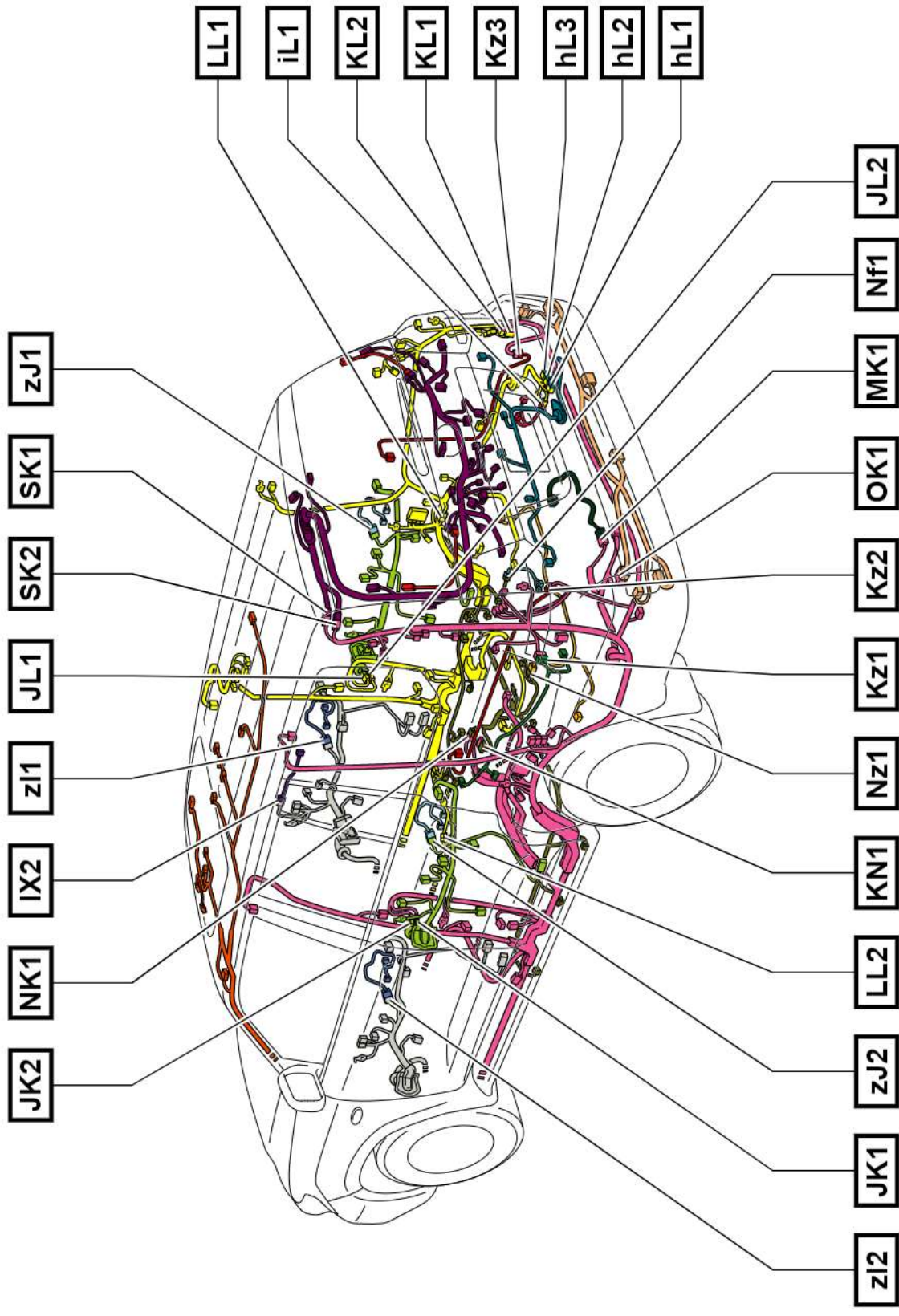

Wire and Wire in Body <RHD Liftgate Type>

IX2
White

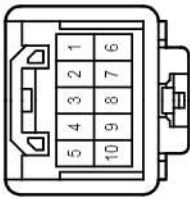
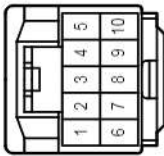

JK1
White

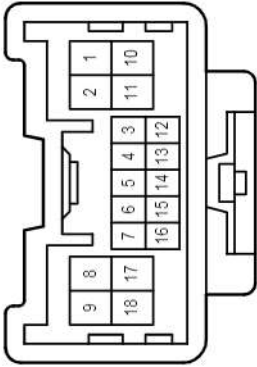
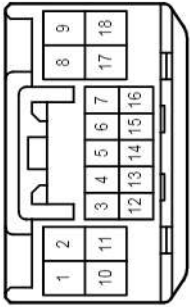

JK2
White

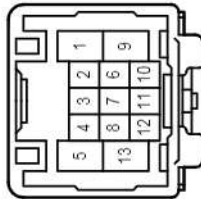
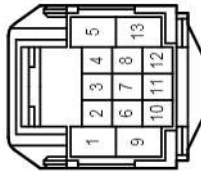

JL1
White

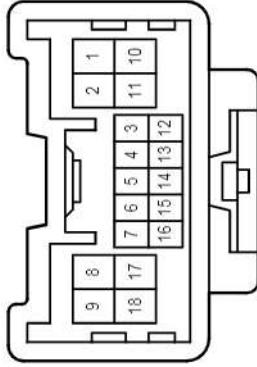
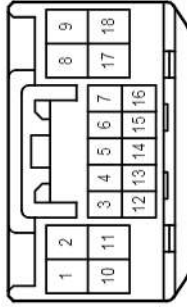

JL2
White

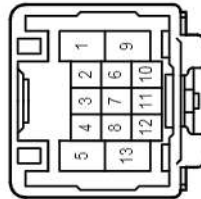
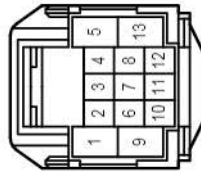

KL1
White

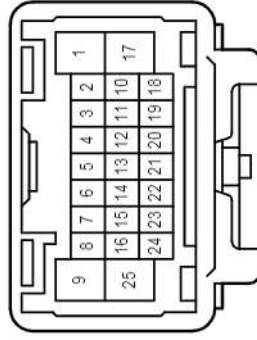
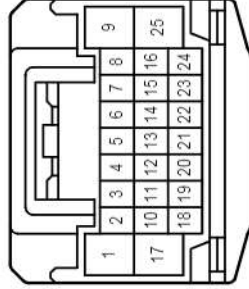

KL2
White

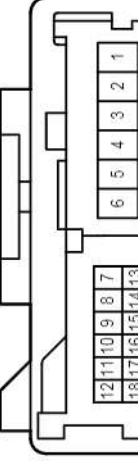
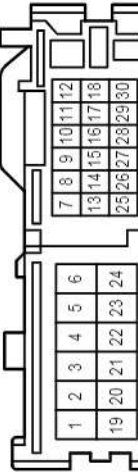

Wire and Wire in Body <RHD Liftgate Type>

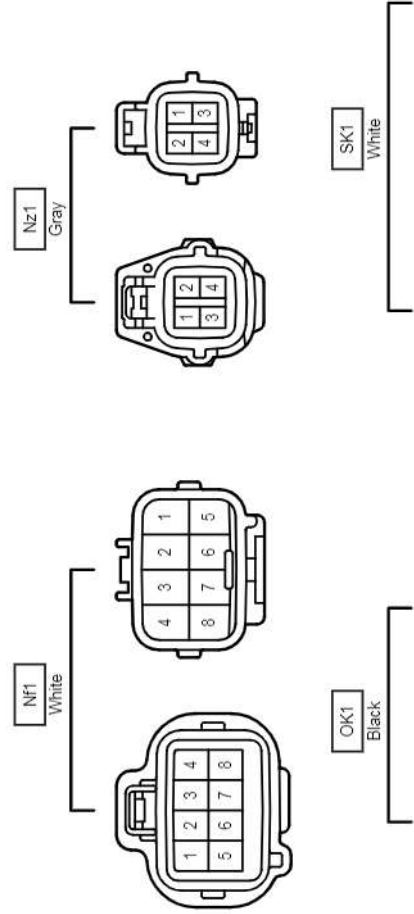
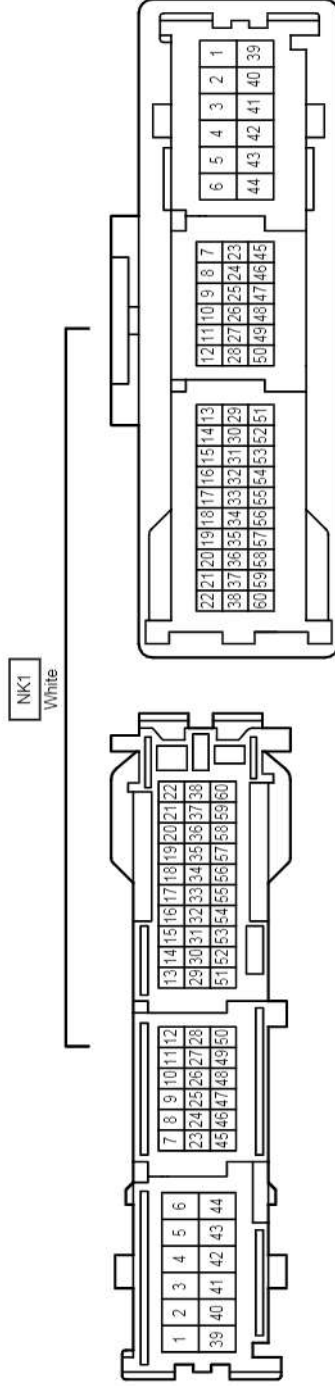
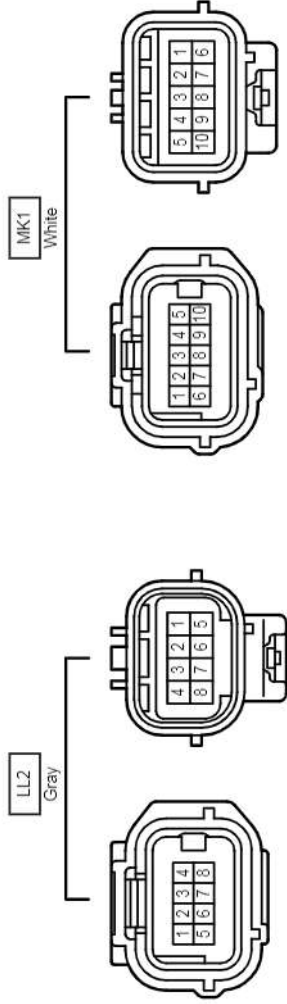
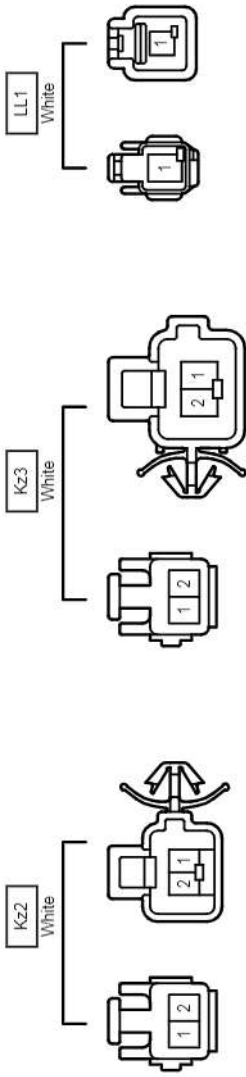

Wire and Wire in Body <RHD Liftgate Type>

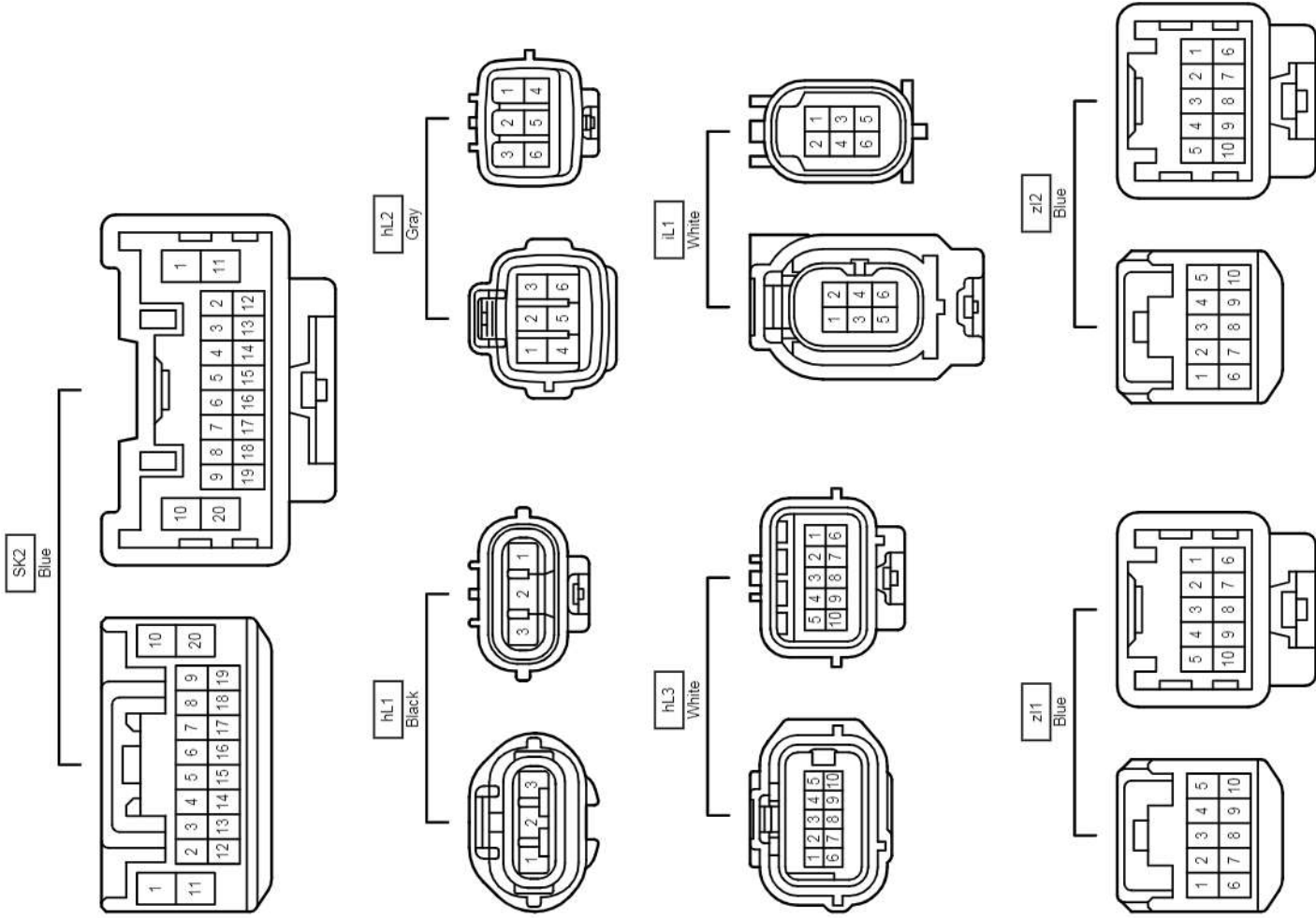

Position of Parts in Seat <LHD Rear No.1 Seat>

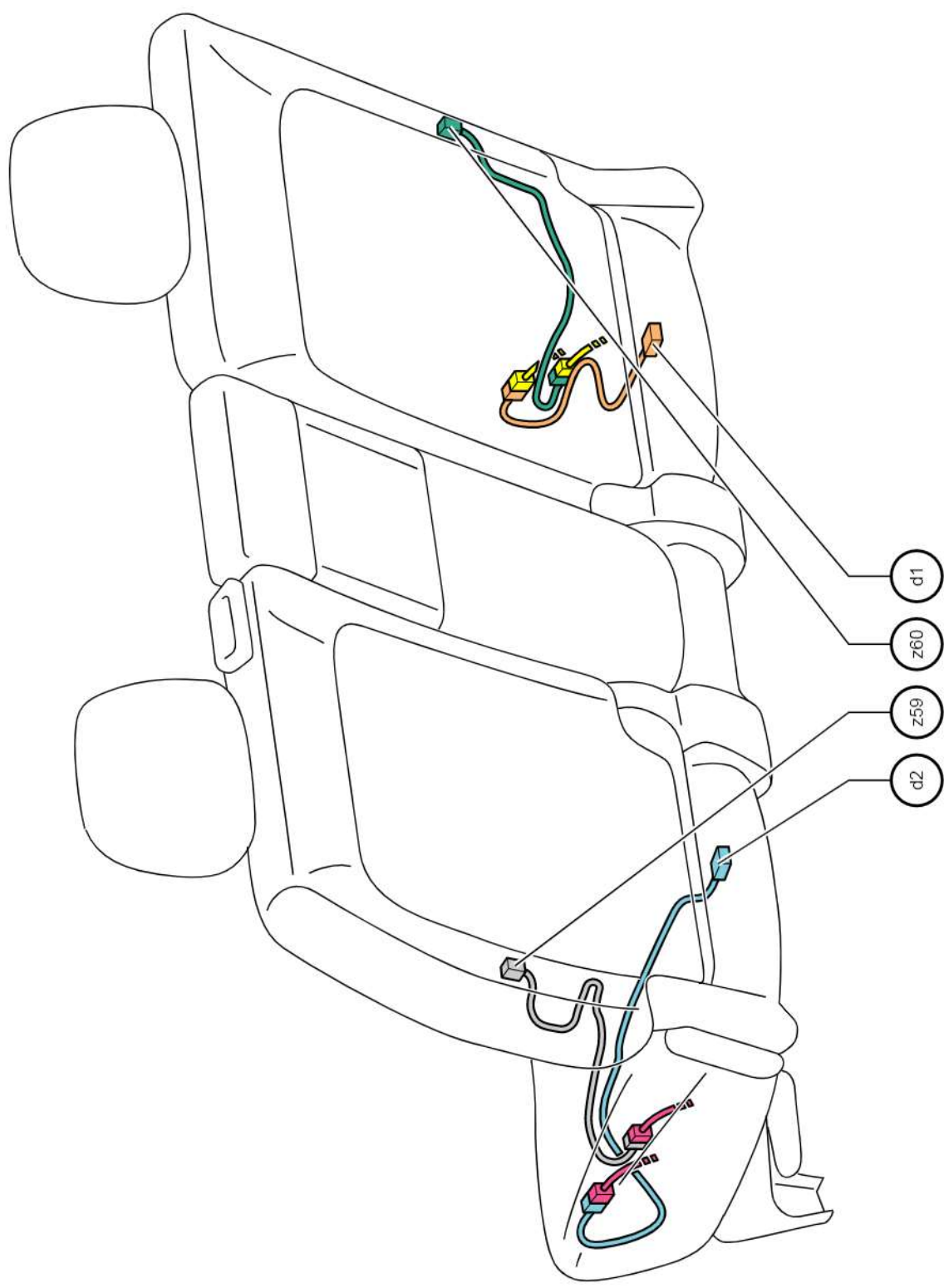

Position of Parts in Seat <LHD Rear No.1 Seat>

d 1 Rear Seat Heater RH
d 2 Rear Seat Heater LH

z 59 Rear Side Airbag Squib Circuit LH
z 60 Rear Side Airbag Squib Circuit RH

Position of Parts in Seat <LHD Rear No.1 Seat>

d 1
White

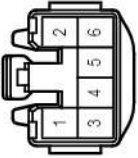

d 2
White

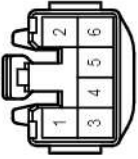

z 59
White

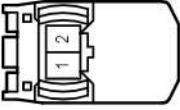

z 60
White

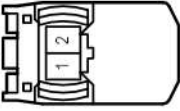

Wire and Wire in Seat <LHD Rear No.1 Seat>

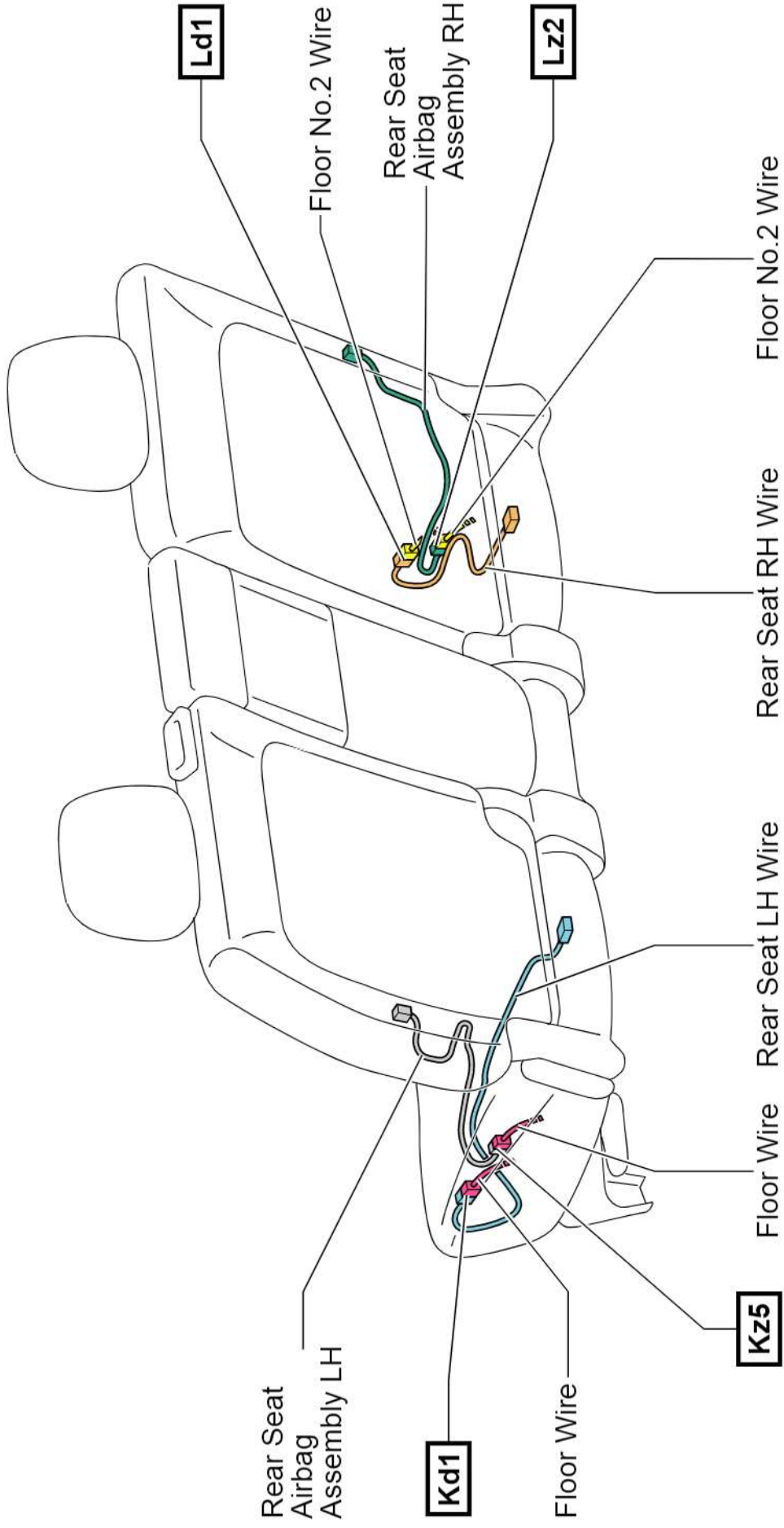

Wire and Wire in Seat <LHD Rear No. 1 Seat>

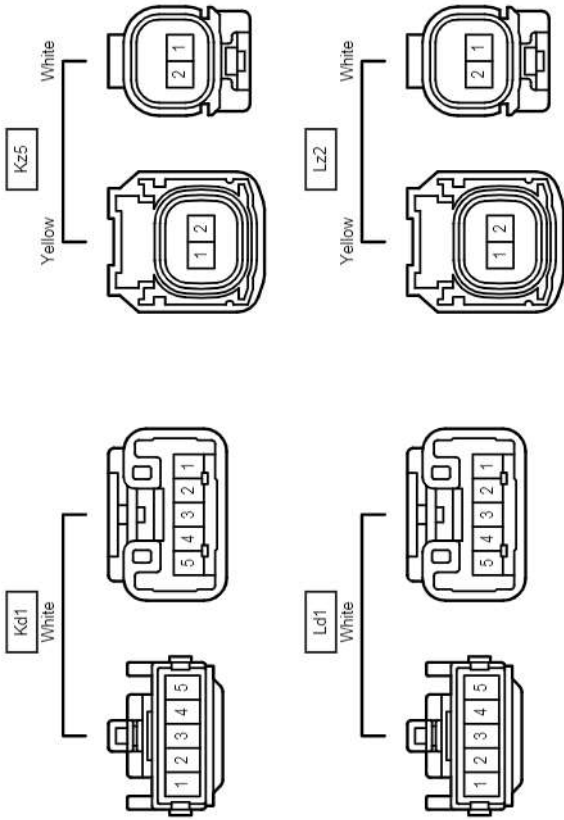

Position of Parts in Seat <RHD Rear No.1 Seat>

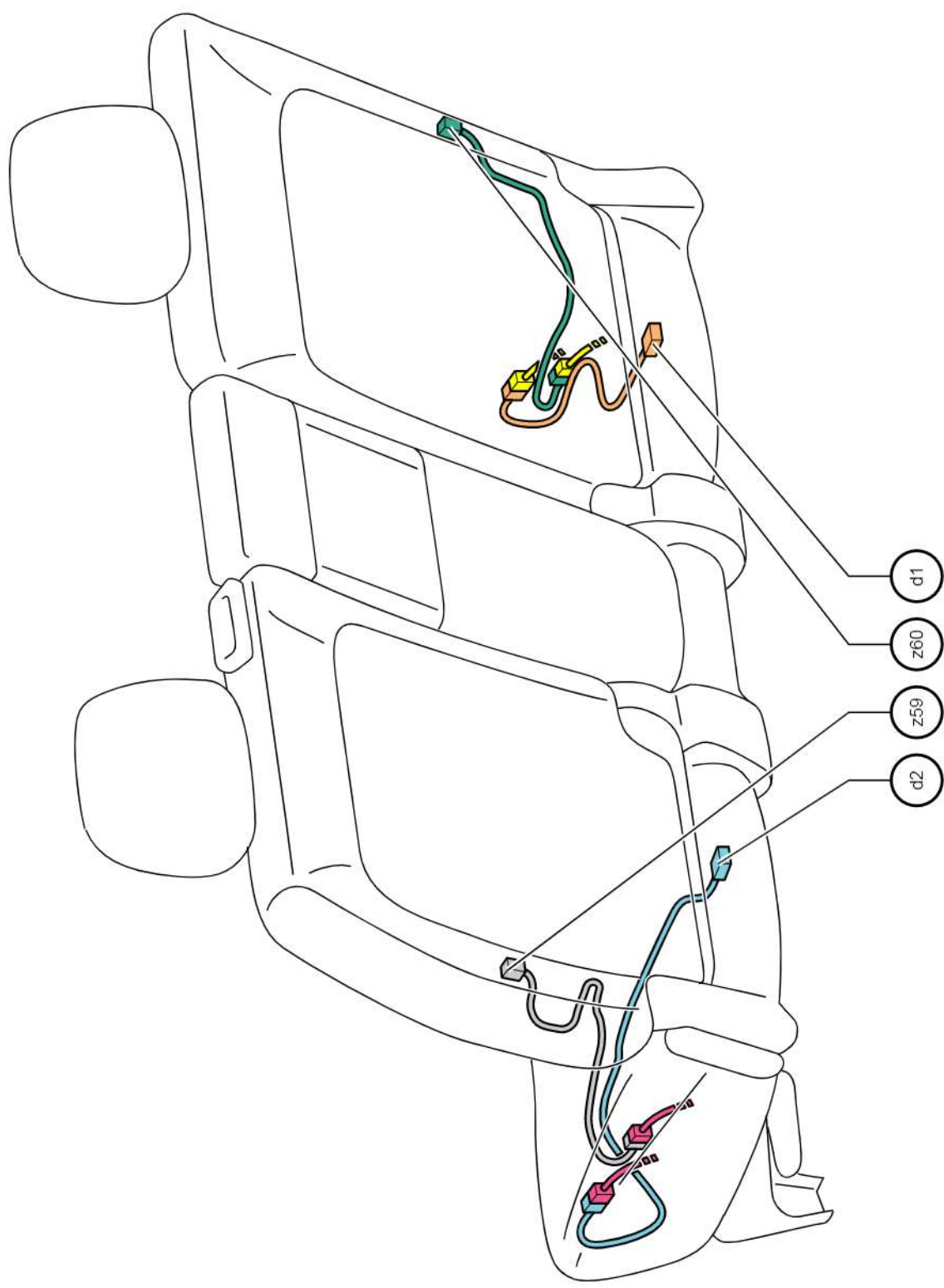

Position of Parts in Seat <RHD Rear No.1 Seat>

d 1 Rear Seat Heater RH
d 2 Rear Seat Heater LH

z 59 Rear Side Airbag Squib Circuit LH
z 60 Rear Side Airbag Squib Circuit RH

Position of Parts in Seat <RHD Rear No.1 Seat>

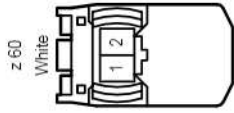
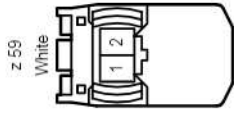
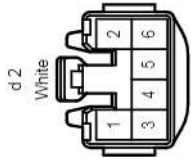
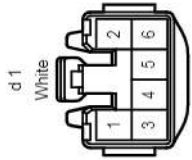

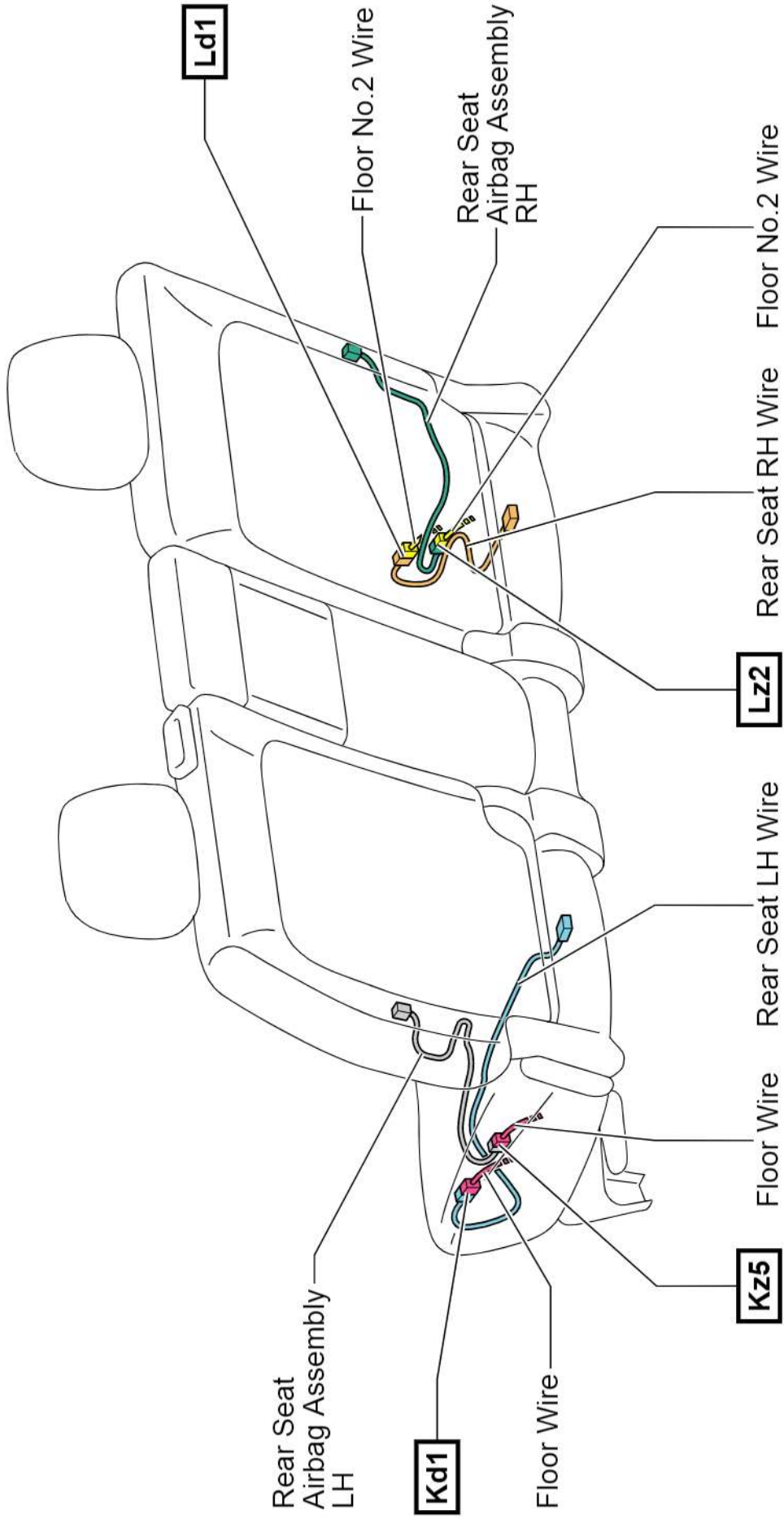

Wire and Wire in Seat <RHD Rear No. 1 Seat>

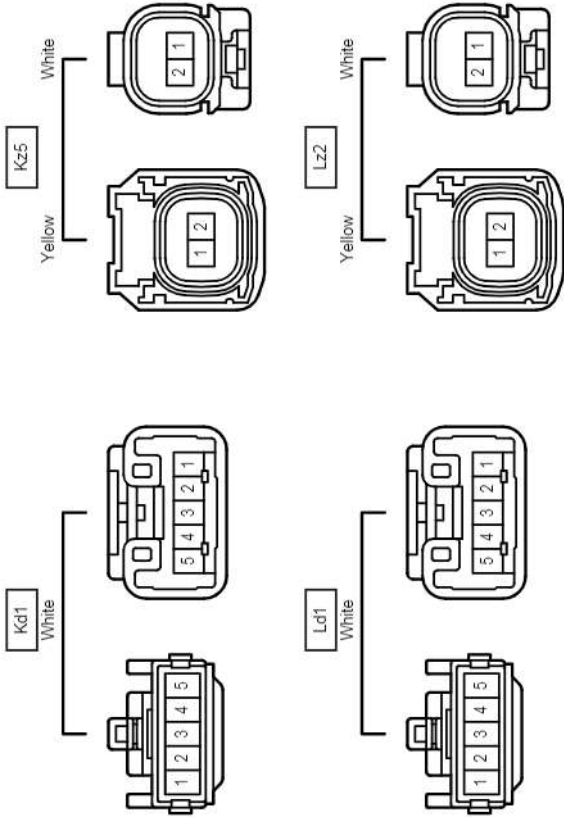

Ground Points in Body <LHD Swing Type>

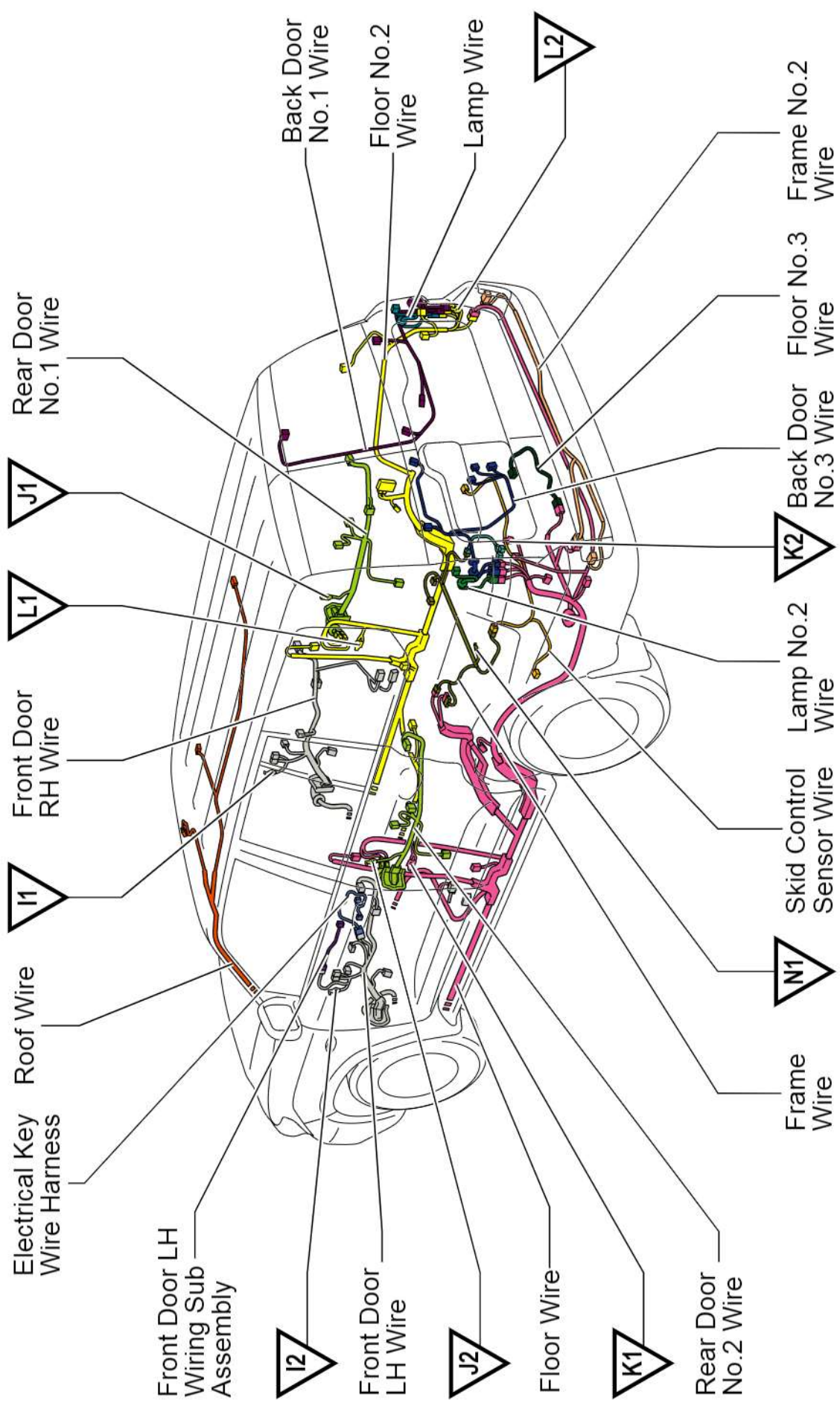

Position of Parts in Body <LHD Swing Type>

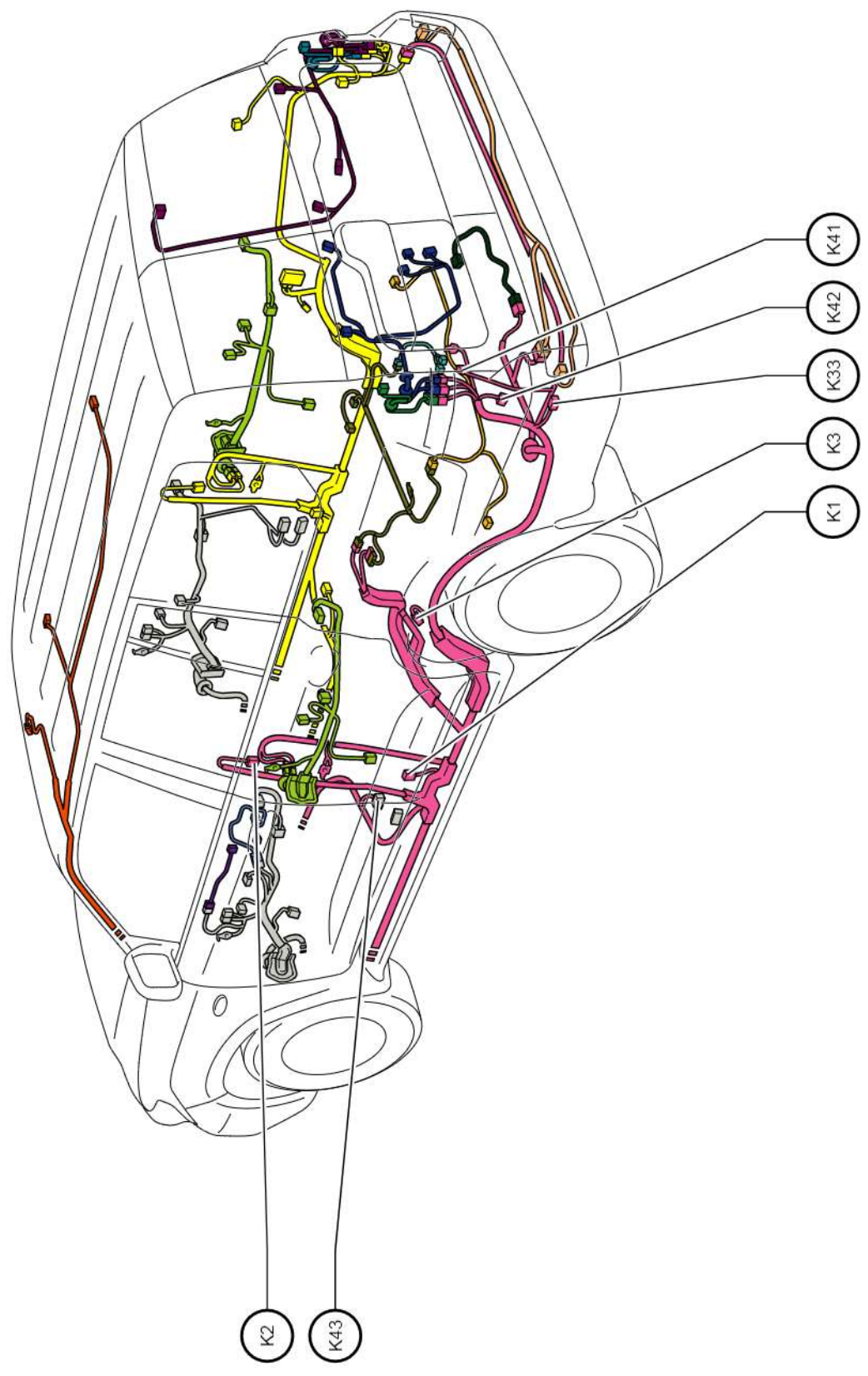

Position of Parts in Body <LHD Swing Type>

- K 1 Front Pretensioner LH
- K 2 Front Door Courtesy Light Switch Assembly LH
- K 3 Rear Door Courtesy Light Switch Assembly LH
- K 33 Diode (Stop Light)
- K 41 Rear Power Outlet Socket Assembly
- K 42 Noise Filter (Rear Window Defogger LH)
- K 43 Front Seat Inner Belt Assembly LH

Position of Parts in Body <LHD Swing Type>

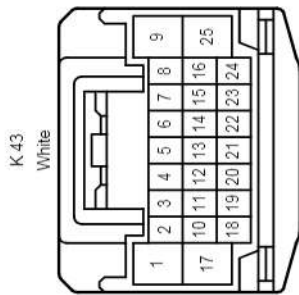
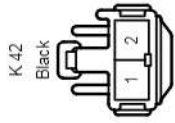
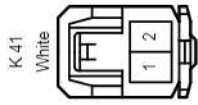
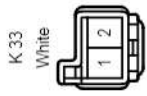
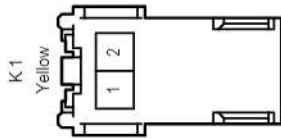

Position of Parts in Body <LHD Swing Type>

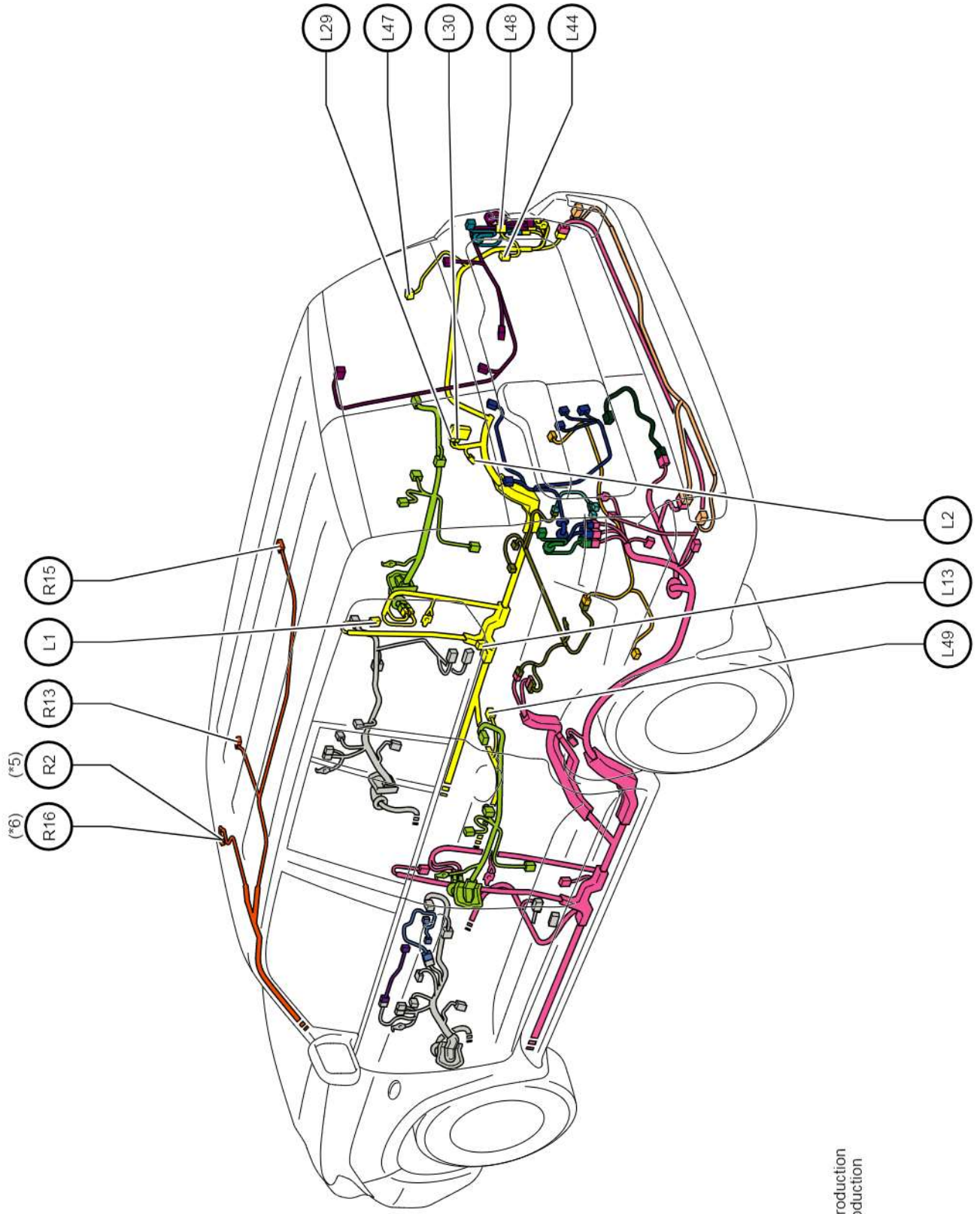

* 5: Before Jan. 2012 Production
* 6: From Jan. 2012 Production

Position of Parts in Body <LHD Swing Type>

- L 1 Front Door Courtesy Light Switch Assembly RH
- L 2 Rear Door Courtesy Light Switch Assembly RH
- L 13 Front Pretensioner RH
- L 29 Junction Connector
- L 30 Junction Connector
- L 44 Option Connector (Parking Assist-Sensor)
- L 47 Door Control Receiver
- L 48 Noise Filter (Rear Window Defogger and Stop)
- L 49 Front Seat Inner Belt Assembly RH

- R 2 Inner Rear View Mirror Assembly
- R 13 No.1 Room Light Assembly
- R 15 No.3 Room Light Assembly
- R 16 Inner Rear View Mirror Assembly

Position of Parts in Body <LHD Swing Type>

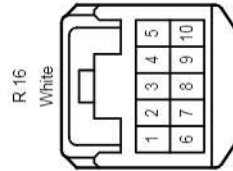
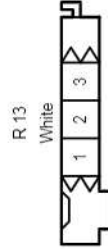
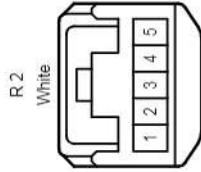
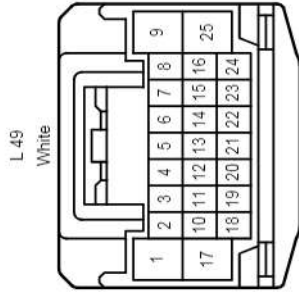
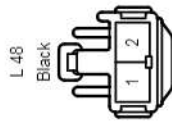
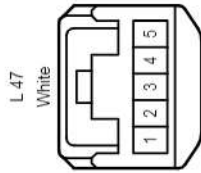
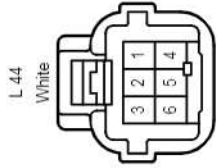
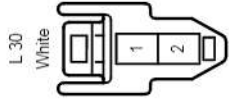
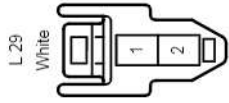
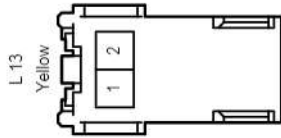

Position of Parts in Body <LHD Swing Type>

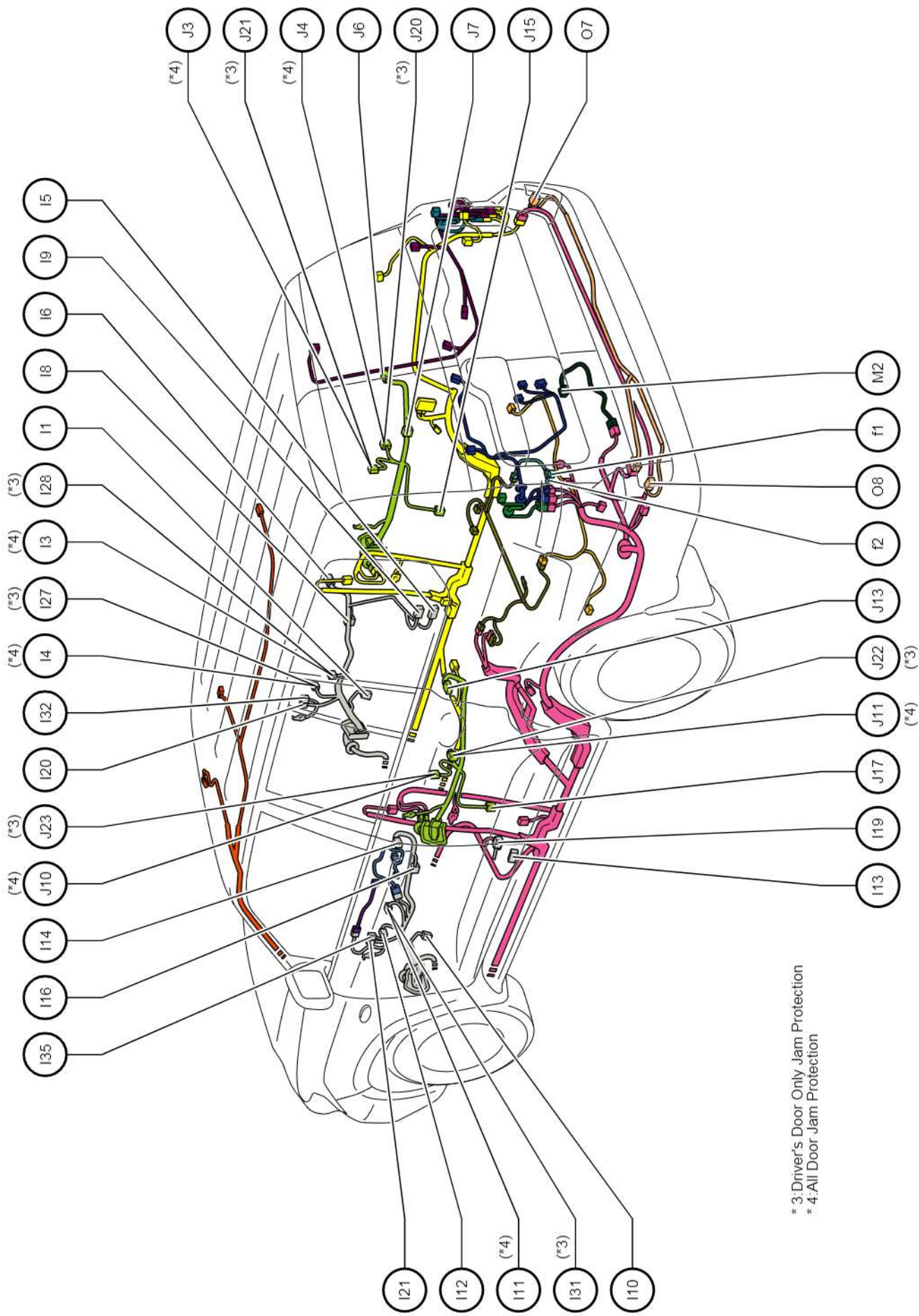

* 3: Driver's Door Only Jam Protection
* 4: All Door Jam Protection

I	1	Front No.1 Speaker Assembly RH
I	3	Front Power Window Regulator Switch Assembly RH
I	4	Front Power Window Regulator Motor Assembly RH
I	5	Front Door Courtesy Light Assembly RH
I	6	Front Door Lock Assembly RH
I	8	Diode (Front Door Courtesy Switch RH)
I	9	Front Side Airbag Sensor Assembly RH
I	10	Front No.1 Speaker Assembly LH
I	11	Multiplex Network Master Switch Assembly
I	12	Front Power Window Regulator Motor Assembly LH
I	13	Front Door Courtesy Light Assembly LH
I	14	Front Door Lock Assembly LH
I	16	Diode (Front Door Courtesy Switch LH)
I	19	Front Side Airbag Sensor Assembly LH
I	20	Outer Rear View Mirror Assembly RH
I	21	Outer Rear View Mirror Assembly LH
I	27	Front Power Window Regulator Motor Assembly RH
I	28	Front Power Window Regulator Switch Assembly RH
I	31	Multiplex Network Master Switch Assembly
I	32	Outer Rear View Mirror Assembly RH
I	35	Outer Rear View Mirror Assembly LH
J	3	Rear Power Window Regulator Switch Assembly RH
J	4	Rear Power Window Regulator Motor Assembly RH
J	6	Rear Door Lock Assembly RH
J	7	Diode (Rear Door Courtesy Switch RH)
J	10	Rear Power Window Regulator Switch Assembly LH
J	11	Rear Power Window Regulator Motor Assembly LH
J	13	Rear Door Lock Assembly LH
J	15	Rear Speaker Set RH
J	17	Rear Speaker Set LH
J	20	Rear Power Window Regulator Motor Assembly RH
J	21	Rear Power Window Regulator Switch Assembly RH
J	22	Rear Power Window Regulator Motor Assembly LH
J	23	Rear Power Window Regulator Switch Assembly LH
M	2	Fuel Sender Gage Assembly (Sub)
O	7	Back-Up Light Assembly RH
O	8	Back-Up Light Assembly LH
f	1	Differential Lock Shift Actuator
f	2	Differential Lock Switch

Position of Parts in Body <LHD Swing Type>

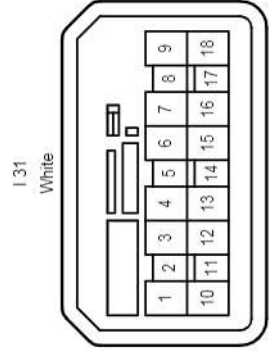
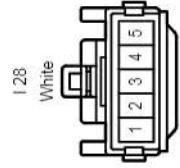
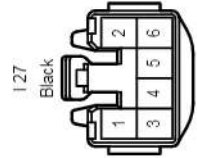
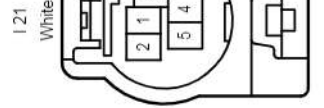
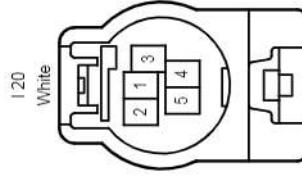
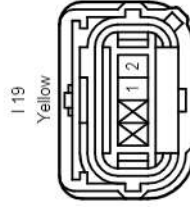
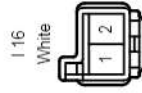
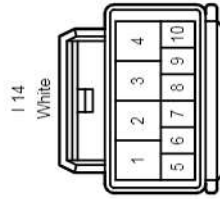
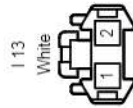
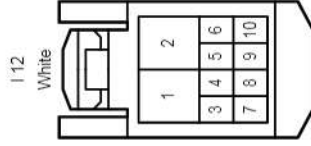
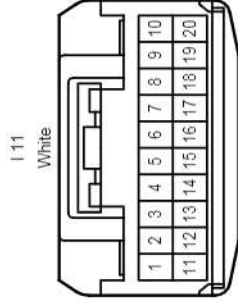
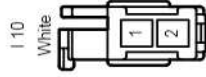
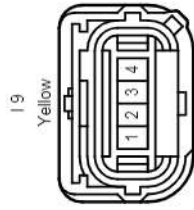
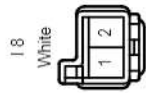
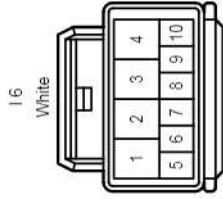
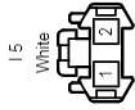
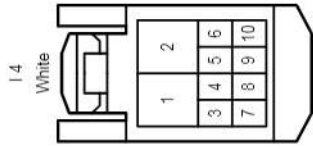
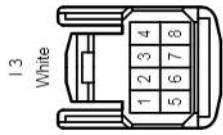
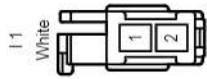

cardiagn.com

Position of Parts in Body <LHD Swing Type>

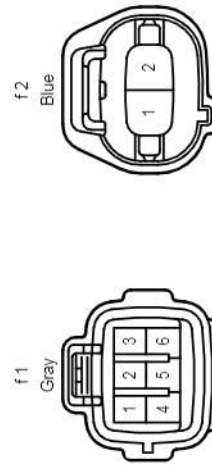
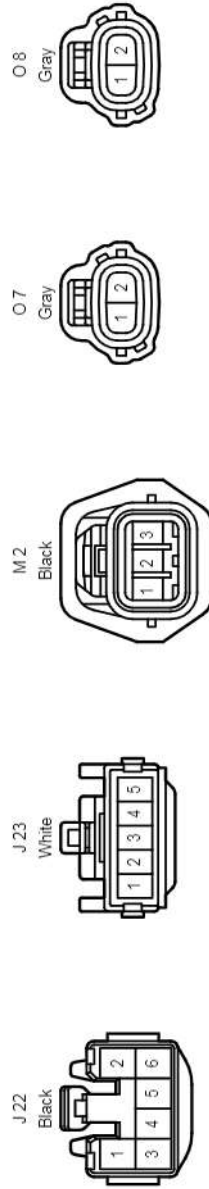
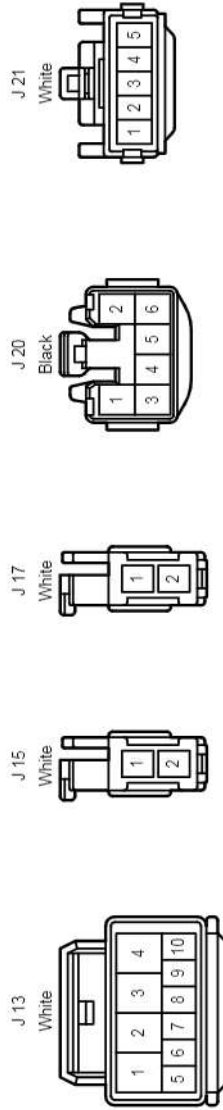
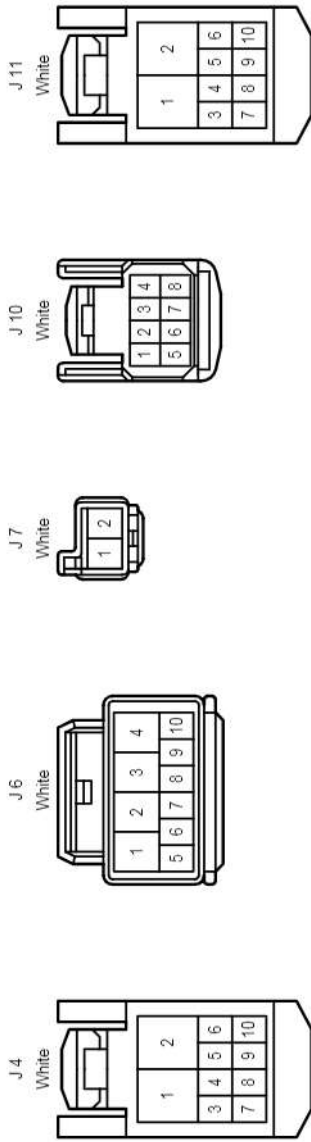

Position of Parts in Body <LHD Swing Type>

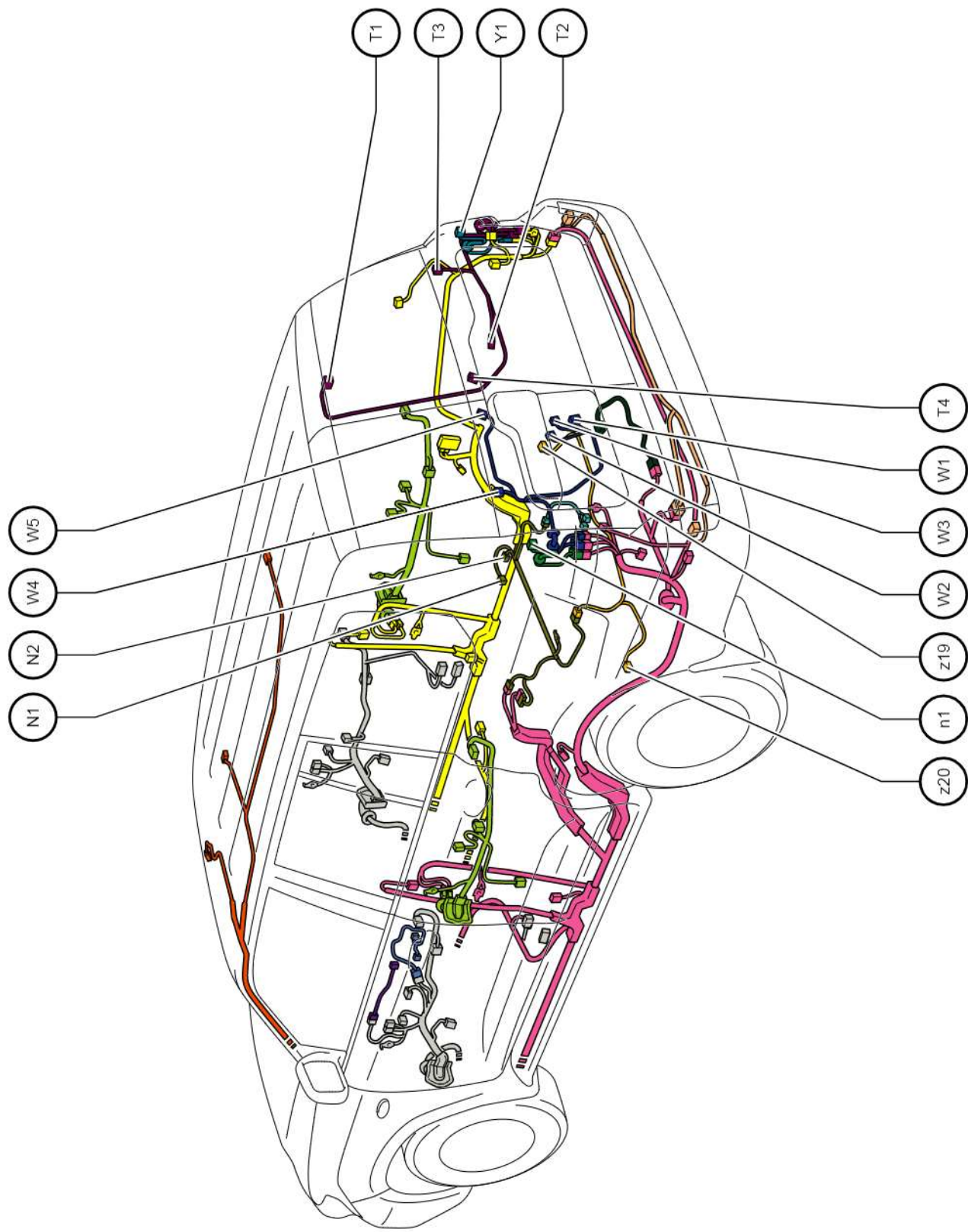

Position of Parts in Body <LHD Swing Type>

N	1	Fuel Sender Gage Assembly (Main)
N	2	Fuel Pump Control ECU Assembly
T	1	Center Stop Light Assembly
T	2	Rear Wiper Motor Assembly
T	3	Rear Window Defogger RH (Back Door Glass)
T	4	Rear Window Defogger RH (Back Door Glass)
W	1	Back Door Lock Assembly
W	2	License Plate Light Assembly
W	3	Back Door Courtesy Light Switch Assembly
W	4	Rear Window Defogger LH (Back Door Glass)
W	5	Rear Window Defogger LH (Back Door Glass)
Y	1	Rear Combination Light Assembly RH
n	1	Rear Combination Light Assembly LH
z	19	Rear Speed Sensor RH
z	20	Rear Speed Sensor LH

Position of Parts in Body <LHD Swing Type>

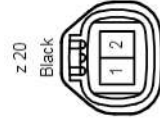
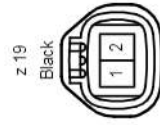
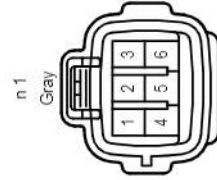
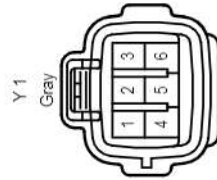
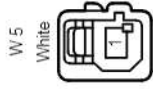
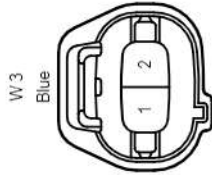
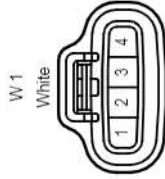
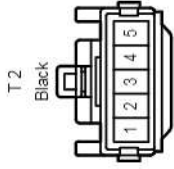
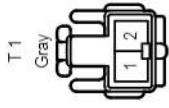
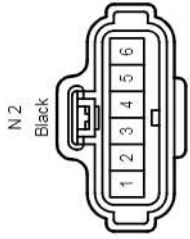
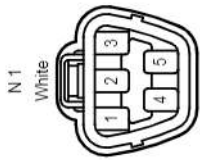

Wire and Wire in Body <LHD Swing Type>

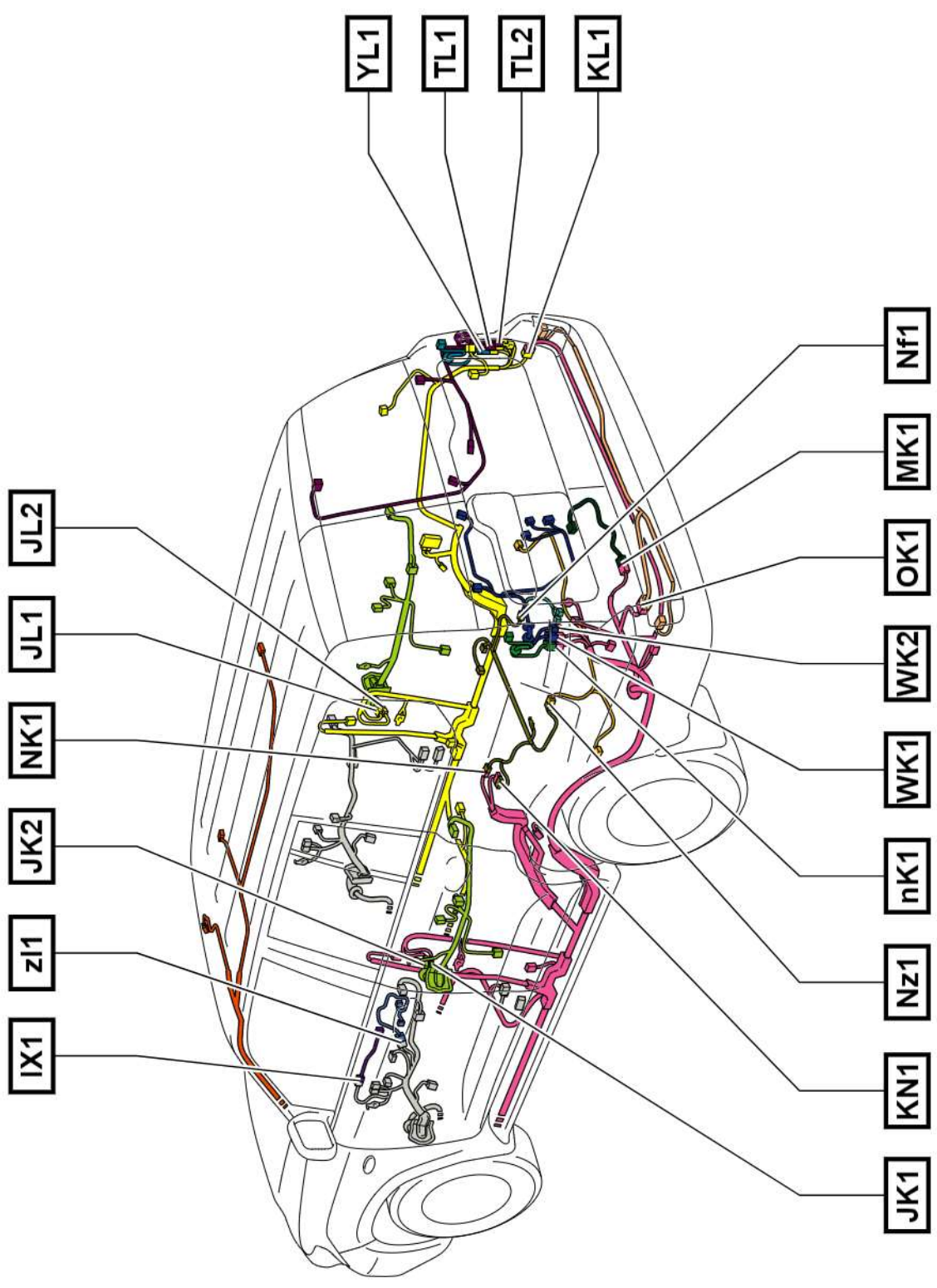

Wire and Wire in Body <LHD Swing Type>

IX1
White

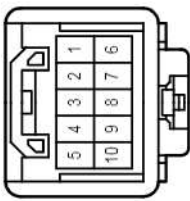
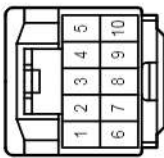

JK1
White

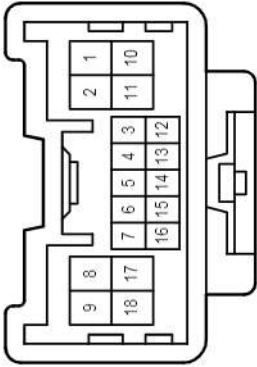
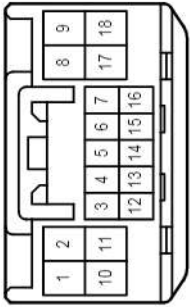

JK2
White

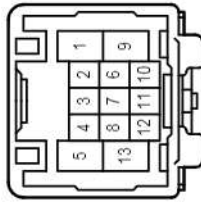
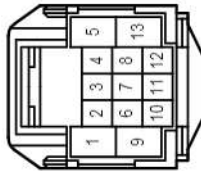

JL1
White

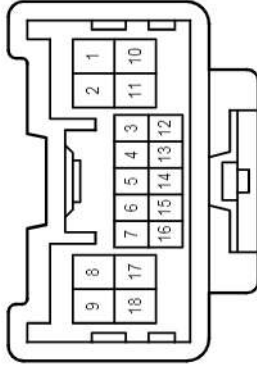
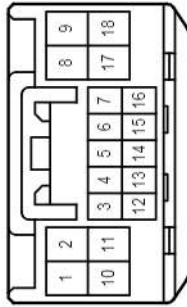

JL2
White

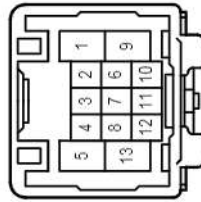
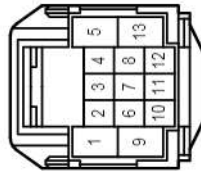

KL1
White

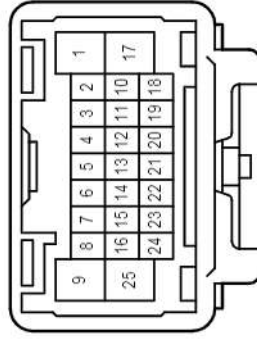
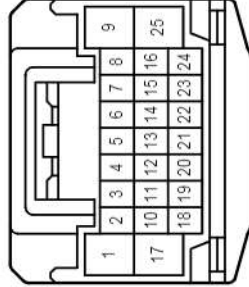

KN1
White

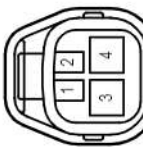

MK1
White

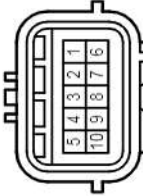
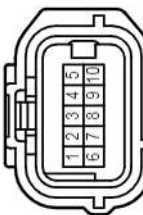

Wire and Wire in Body <LHD Swing Type>

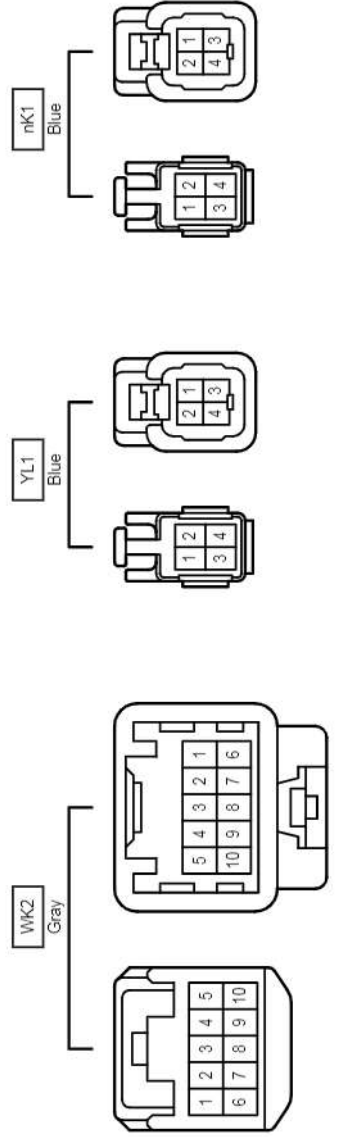
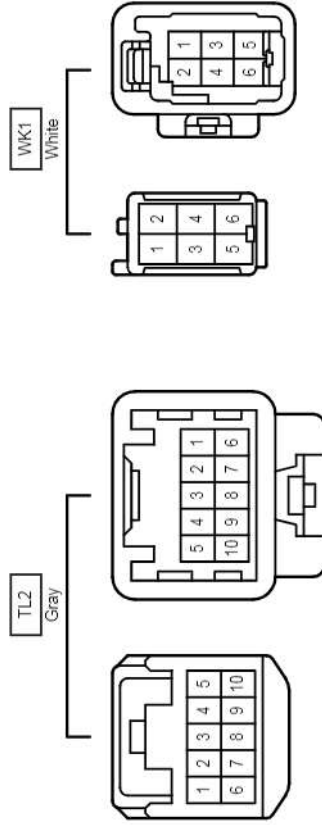
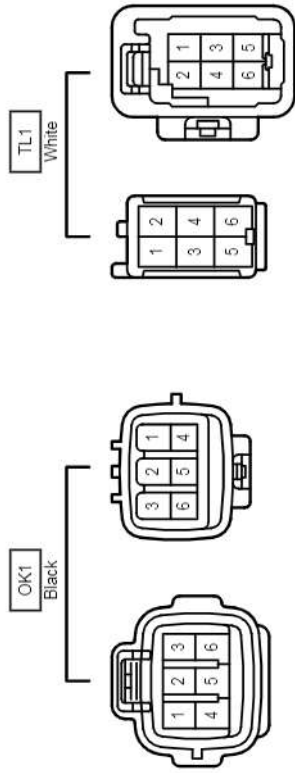
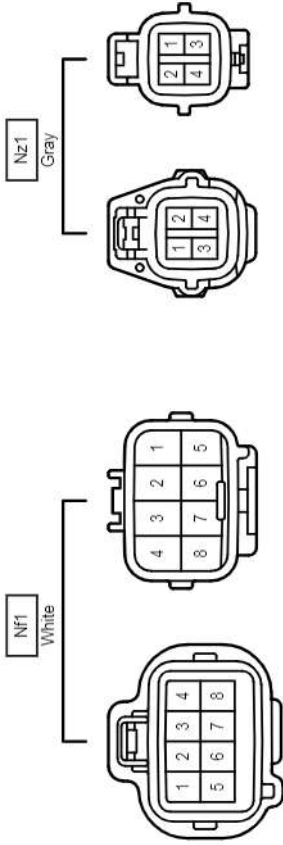

z1 Blue

Ground Points in Body <RHD Swing Type>

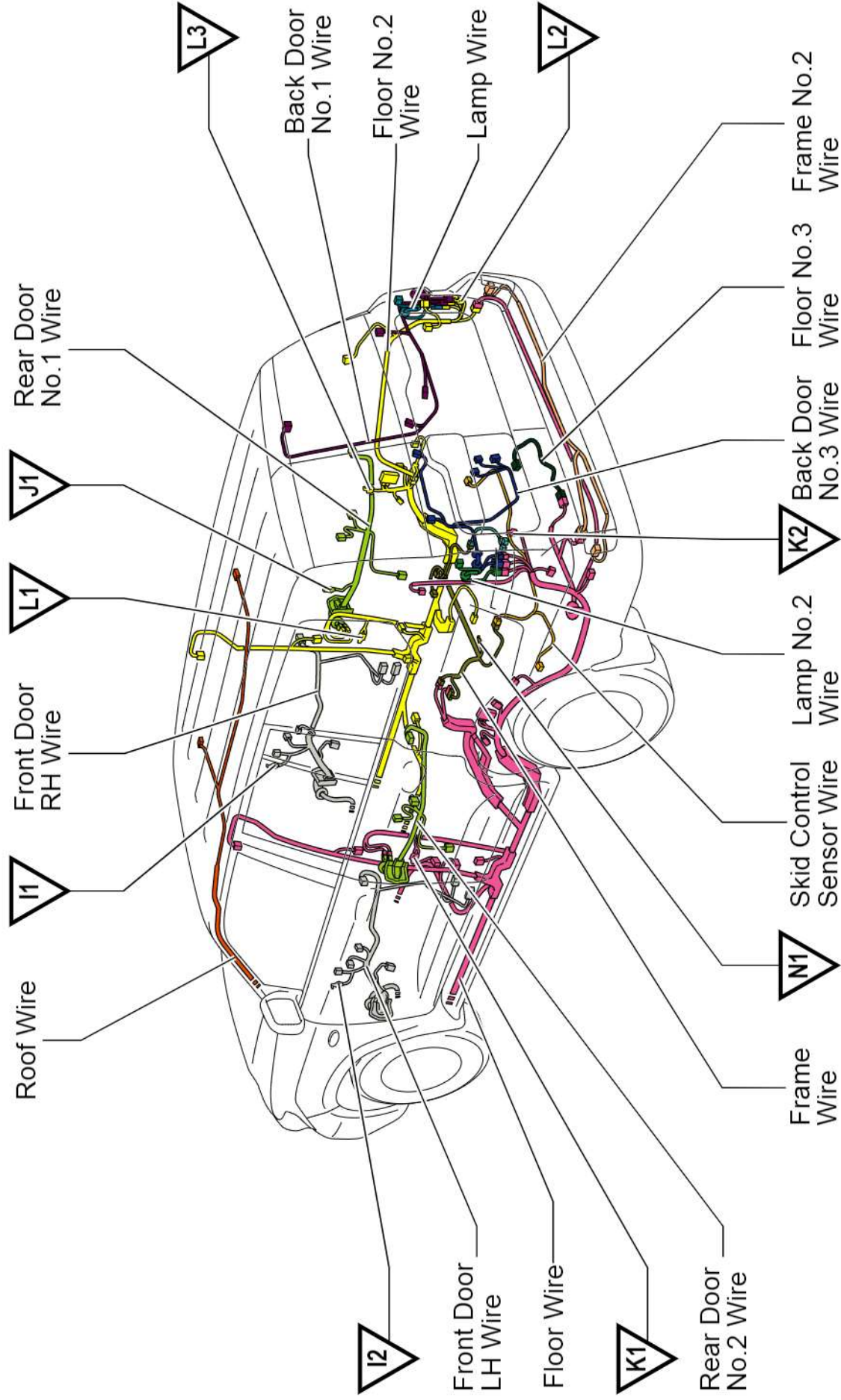

Position of Parts in Body <RHD Swing Type>

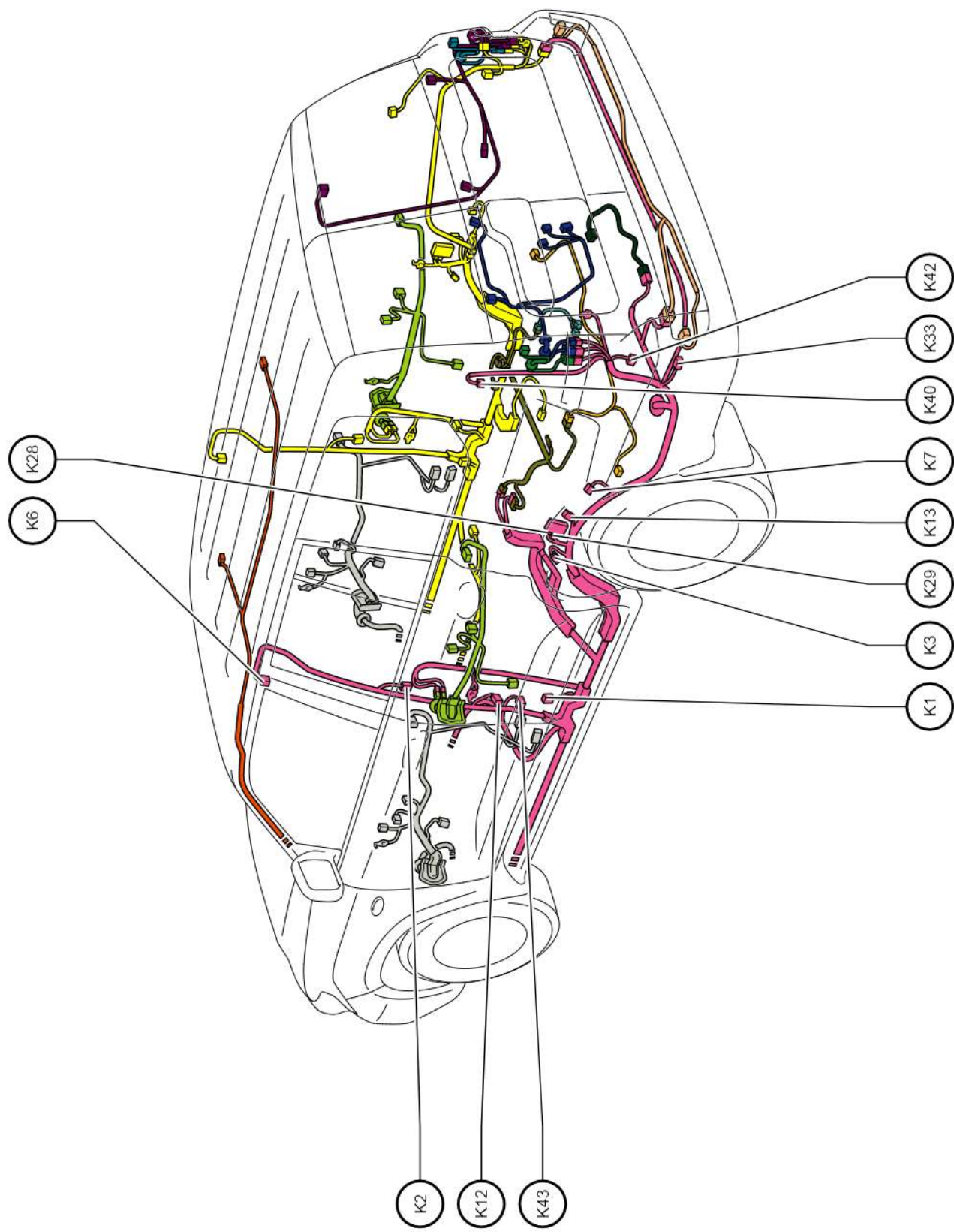

Position of Parts in Body <RHD Swing Type>

- K 1 Front Pretensioner LH
- K 2 Front Door Courtesy Light Switch Assembly LH
- K 3 Rear Door Courtesy Light Switch Assembly LH
- K 6 Curtain Shield Airbag Assembly Circuit LH
- K 7 Rear Side Airbag Sensor Assembly LH
- K 12 Front Tension Reducer LH
- K 13 Rear Pretensioner LH
- K 28 Junction Connector
- K 29 Junction Connector
- K 33 Diode (Stop Light)
- K 40 Towing Converter
- K 42 Noise Filter (Rear Window Defogger LH)
- K 43 Front Seat Inner Belt Assembly LH

Position of Parts in Body <RHD Swing Type>

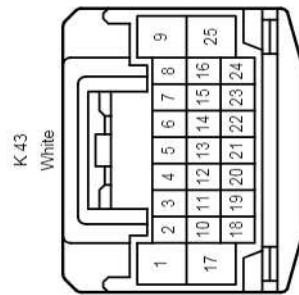
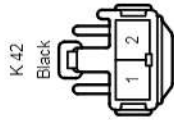
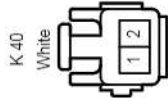
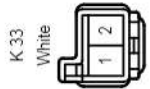
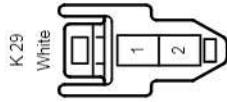
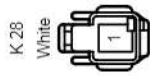
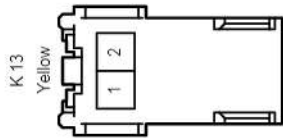
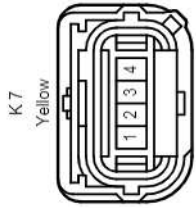
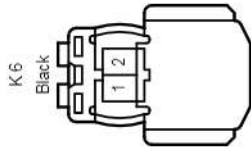
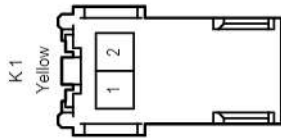

Position of Parts in Body <RHD Swing Type>

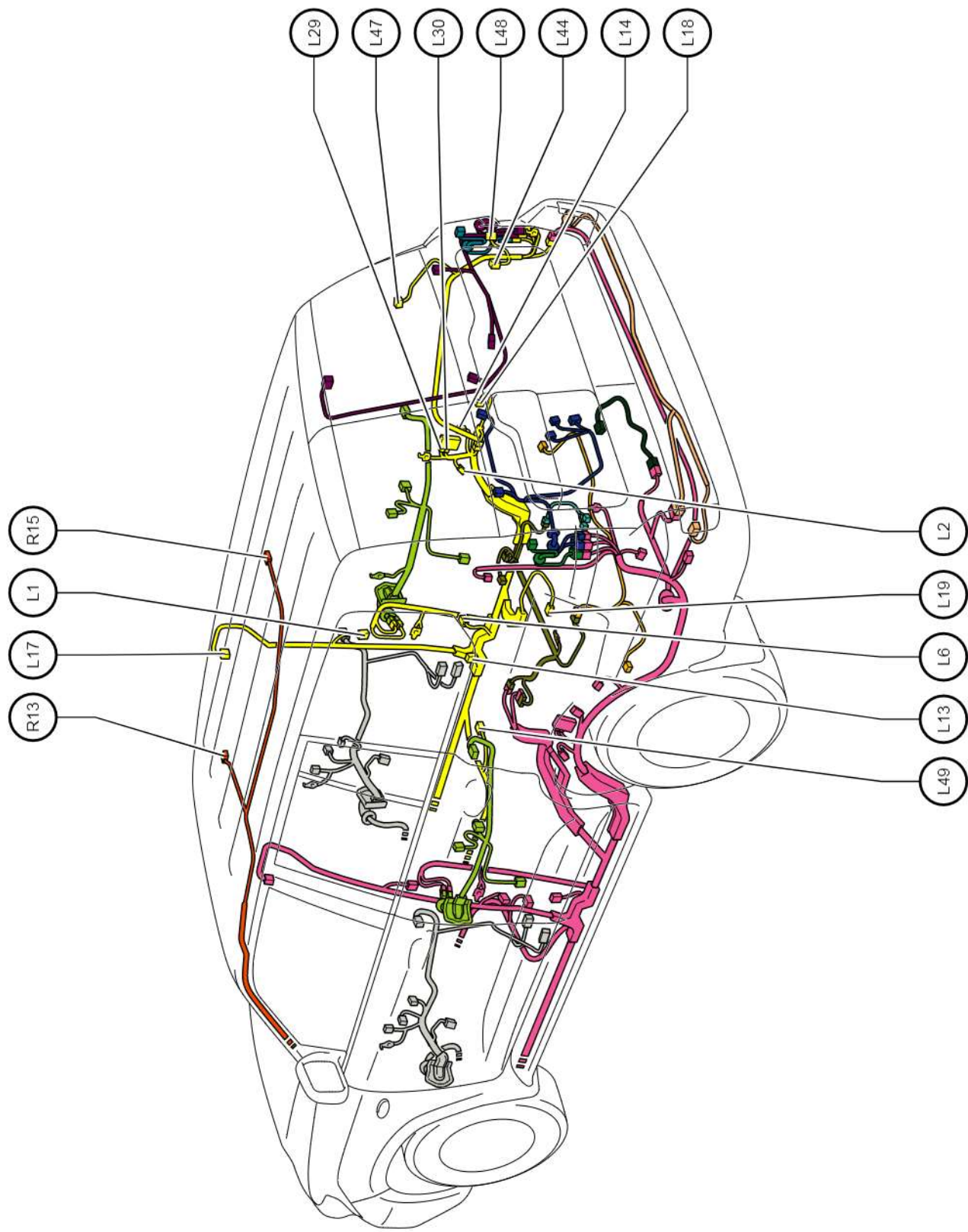

Position of Parts in Body <RHD Swing Type>

- L 1 Front Door Courtesy Light Switch Assembly RH
- L 2 Rear Door Courtesy Light Switch Assembly RH
- L 6 Front Tension Reducer RH
- L 13 Front Pretensioner RH
- L 14 Rear Pretensioner RH
- L 17 Curtain Shield Airbag Assembly Circuit RH
- L 18 Rear Side Airbag Sensor Assembly RH
- L 19 Rear Floor Side Airbag Sensor
- L 29 Junction Connector
- L 30 Junction Connector
- L 44 Option Connector (Parking Assist-Sensor)
- L 47 Door Control Receiver
- L 48 Noise Filter (Rear Window Defogger and Stop)
- L 49 Front Seat Inner Belt Assembly RH

- R 13 No.1 Room Light Assembly
- R 15 No.3 Room Light Assembly

Position of Parts in Body <RHD Swing Type>

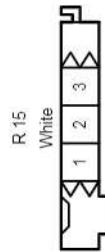
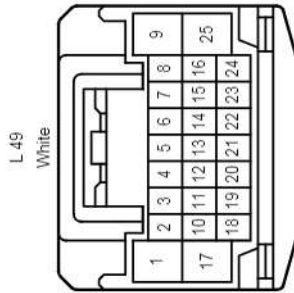
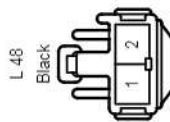
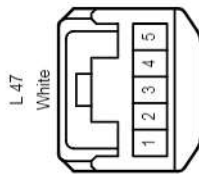
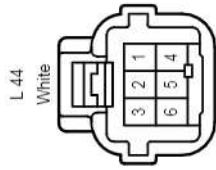
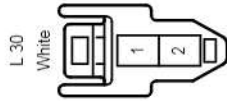
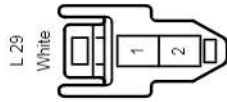
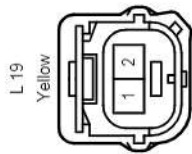
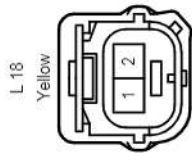
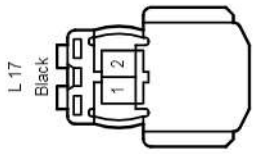
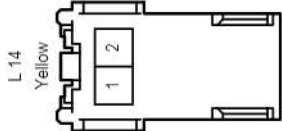
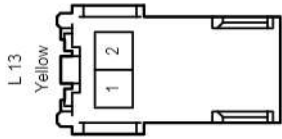

Position of Parts in Body <RHD Swing Type>

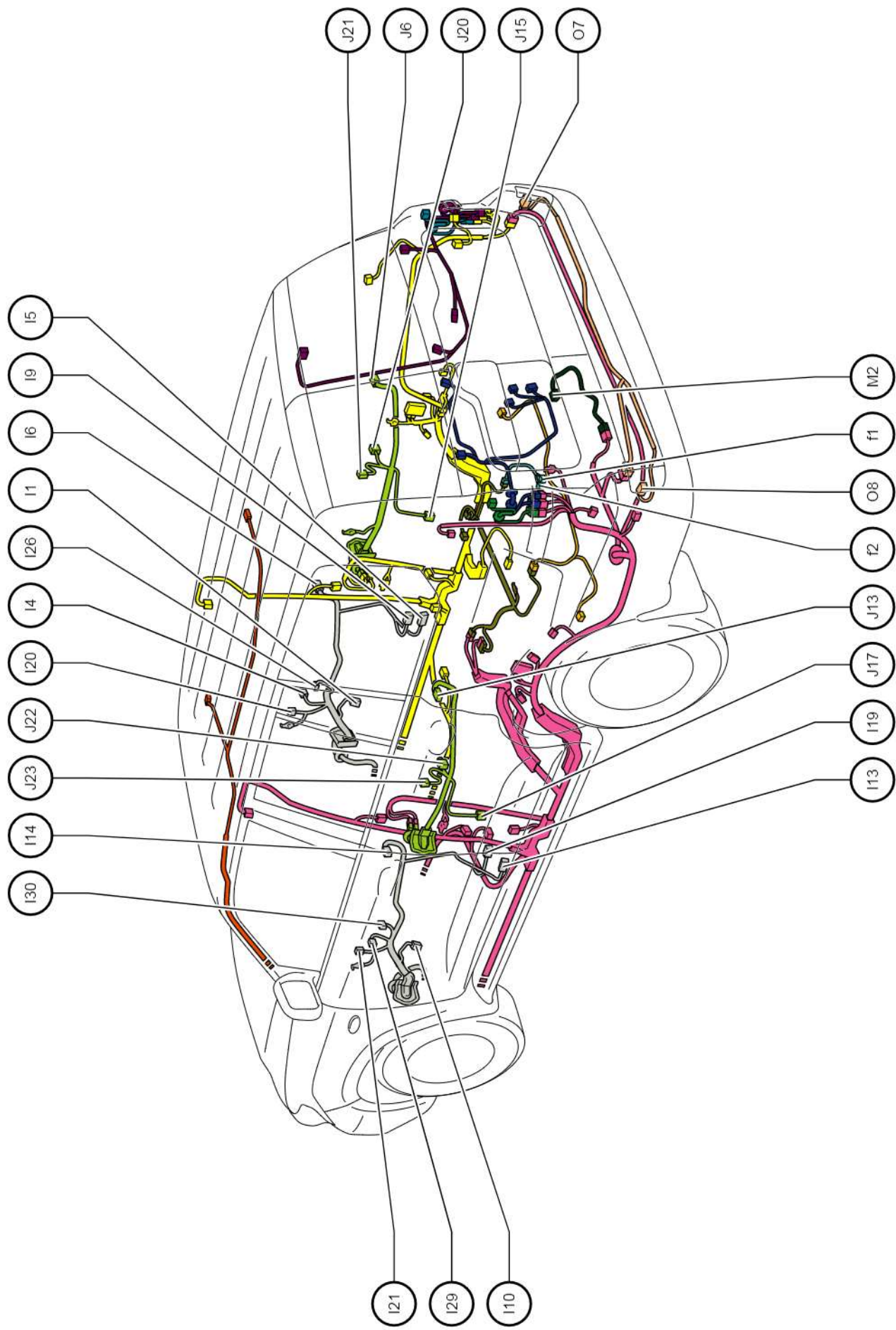

Position of Parts in Body <RHD Swing Type>

- I 1 Front No.1 Speaker Assembly RH
- I 4 Front Power Window Regulator Motor Assembly RH
- I 5 Front Door Courtesy Light Assembly RH
- I 6 Front Door Lock Assembly RH
- I 9 Front Side Airbag Sensor Assembly RH
- I 10 Front No.1 Speaker Assembly LH
- I 13 Front Door Courtesy Light Assembly LH
- I 14 Front Door Lock Assembly LH
- I 19 Front Side Airbag Sensor Assembly LH
- I 20 Outer Rear View Mirror Assembly RH
- I 21 Outer Rear View Mirror Assembly LH
- I 26 Multiplex Network Master Switch Assembly
- I 29 Front Power Window Regulator Motor Assembly LH
- I 30 Front Power Window Regulator Switch Assembly LH

- J 6 Rear Door Lock Assembly RH
- J 13 Rear Door Lock Assembly LH
- J 15 Rear Speaker Set RH
- J 17 Rear Speaker Set LH
- J 20 Rear Power Window Regulator Motor Assembly RH
- J 21 Rear Power Window Regulator Switch Assembly RH
- J 22 Rear Power Window Regulator Motor Assembly LH
- J 23 Rear Power Window Regulator Switch Assembly LH

M 2 Fuel Sender Gage Assembly (Sub)

- O 7 Back-Up Light Assembly RH
- O 8 Back-Up Light Assembly LH

- f 1 Differential Lock Shift Actuator
- f 2 Differential Lock Switch

Position of Parts in Body <RHD Swing Type>

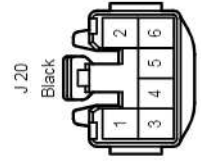
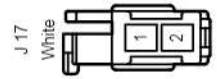
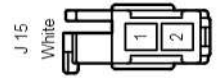
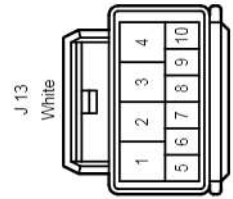
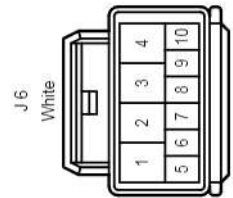
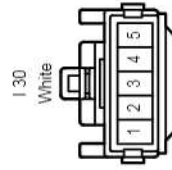
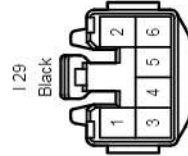
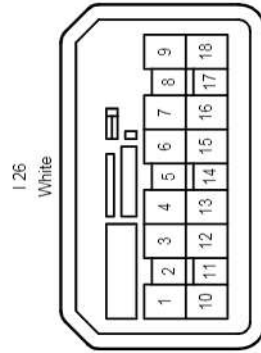
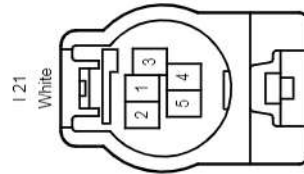
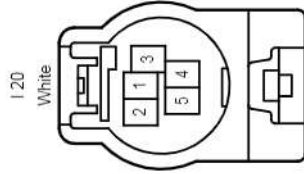
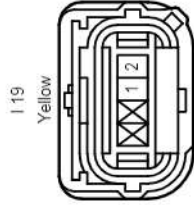
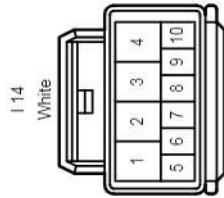
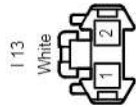
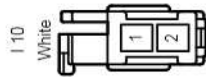
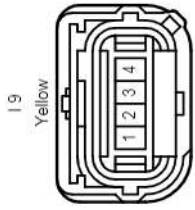
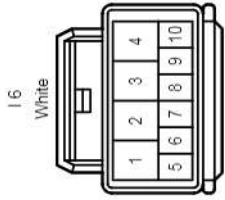
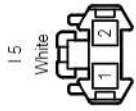
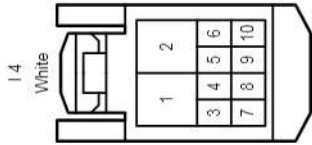
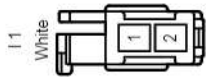

Position of Parts in Body <RHD Swing Type>

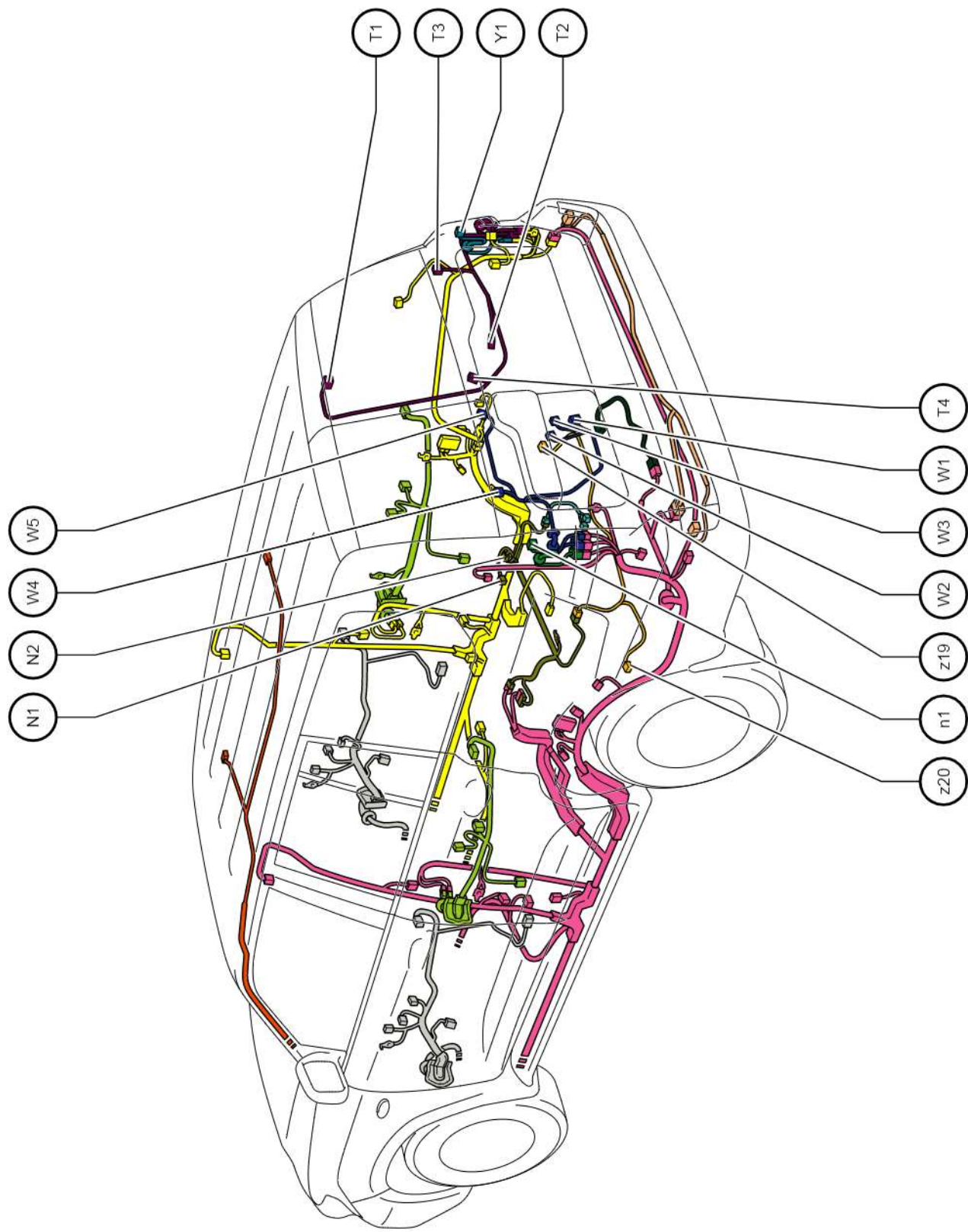

Position of Parts in Body <RHD Swing Type>

N	1	Fuel Sender Gage Assembly (Main)
N	2	Fuel Pump Control ECU Assembly
T	1	Center Stop Light Assembly
T	2	Rear Wiper Motor Assembly
T	3	Rear Window Defogger RH (Back Door Glass)
T	4	Rear Window Defogger RH (Back Door Glass)
W	1	Back Door Lock Assembly
W	2	License Plate Light Assembly
W	3	Back Door Courtesy Light Switch Assembly
W	4	Rear Window Defogger LH (Back Door Glass)
W	5	Rear Window Defogger LH (Back Door Glass)
Y	1	Rear Combination Light Assembly RH
n	1	Rear Combination Light Assembly LH
z	19	Rear Speed Sensor RH
z	20	Rear Speed Sensor LH

Position of Parts in Body <RHD Swing Type>

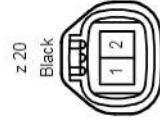
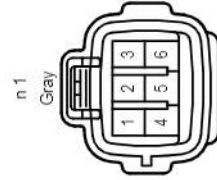
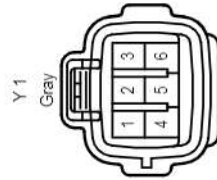
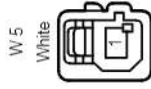
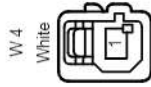
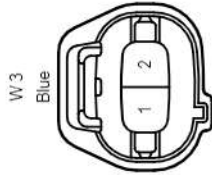
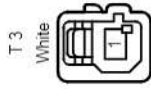
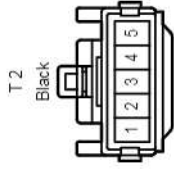
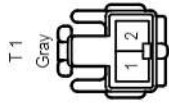
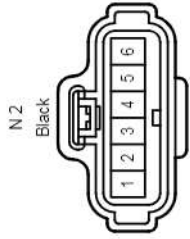
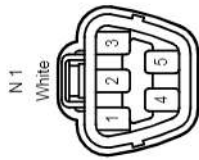

Wire and Wire in Body <RHD Swing Type>

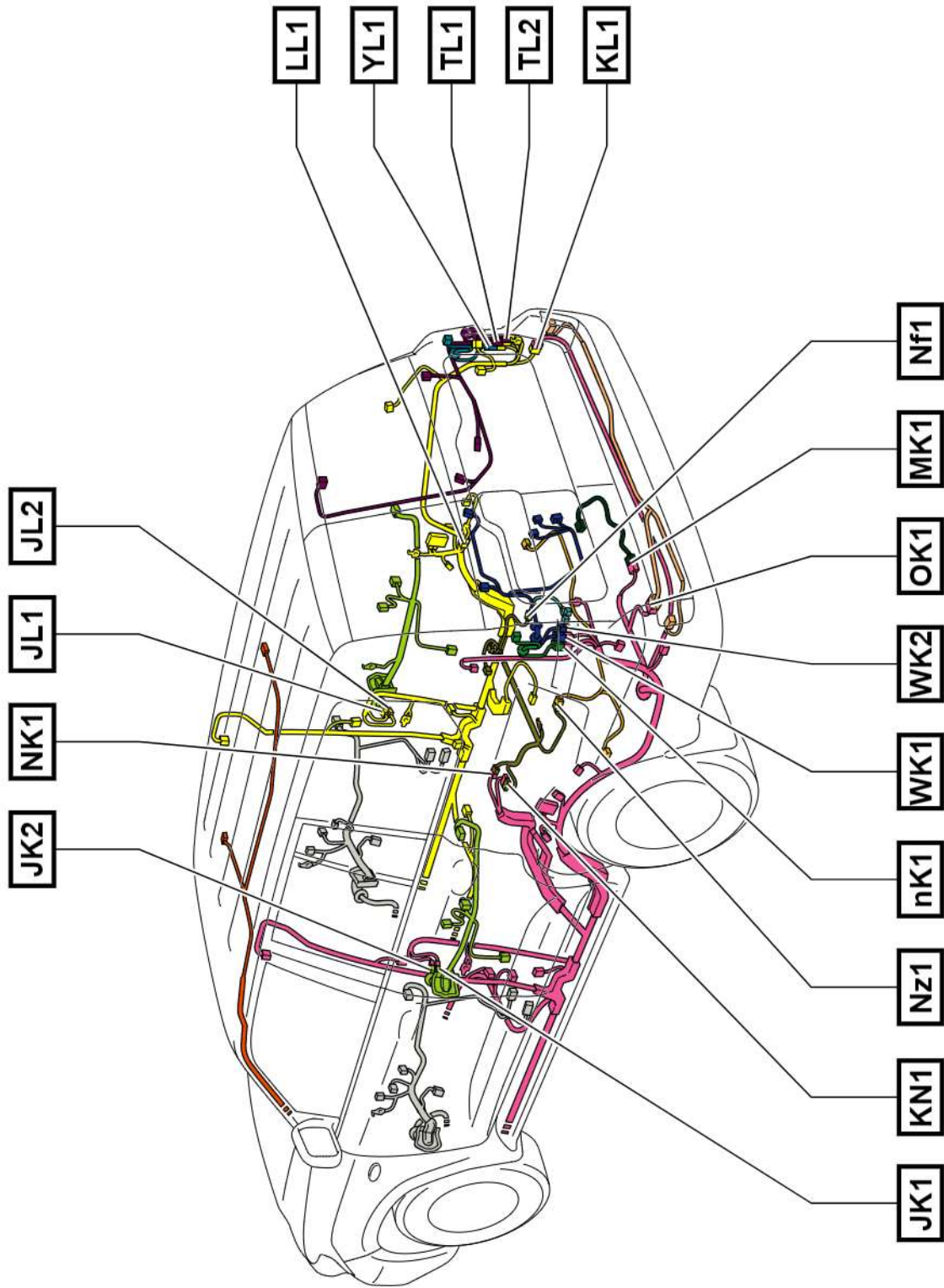

Wire and Wire in Body <RHD Swing Type>

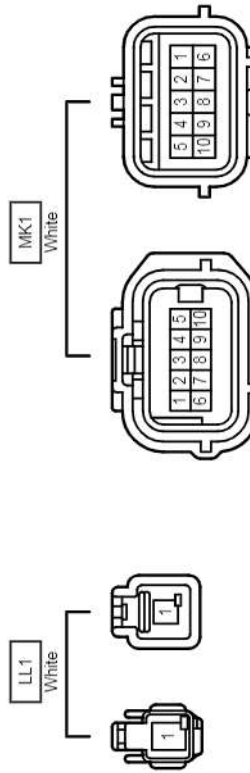
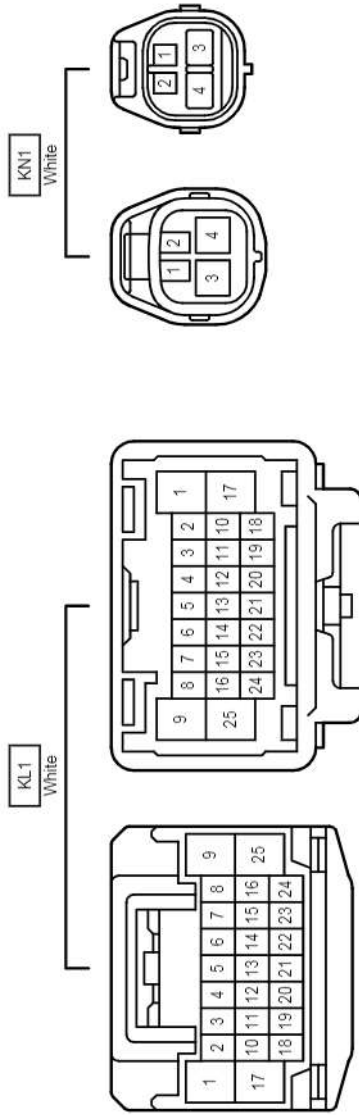
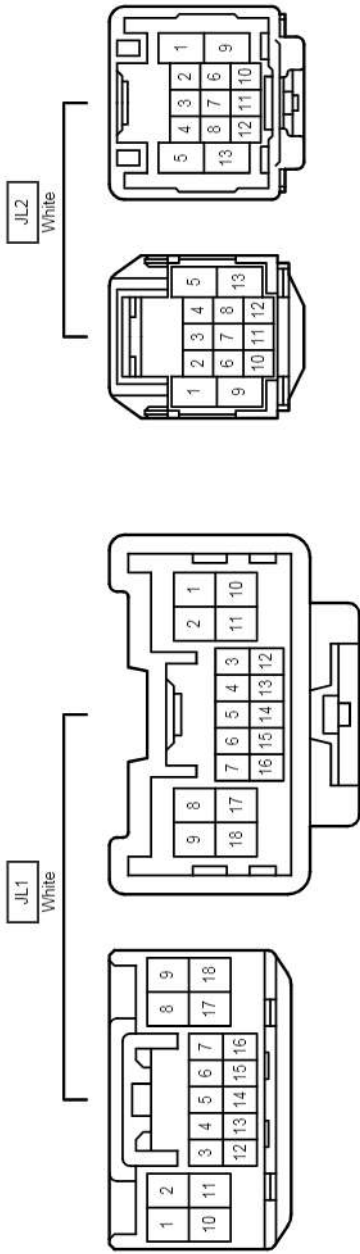
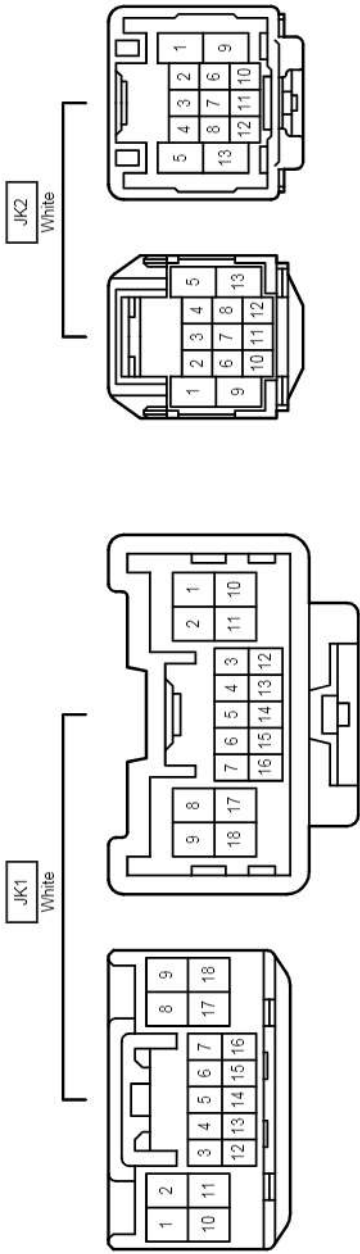

Wire and Wire in Body <RHD Swing Type>

